



**stratasys**<sup>®</sup>

Objet30

3D Printing System



## Copyright

Copyright © 2016 Stratasys Ltd. All rights reserved.

This documentation contains proprietary information of Stratasys Ltd. This information is supplied solely to assist authorized users of Objet30 3D printing systems. No part of this document may be used for other purposes, and it may not be disclosed to other parties.

The specifications on which this document is based are subject to change without notice.

## Trademarks

The following are registered trademarks of Stratasys Ltd.: Stratasys<sup>®</sup>, Objet<sup>®</sup>, FullCure<sup>®</sup>.

The following are trademarks of Stratasys Ltd.: Objet30, Objet30-Pro, Objet30-OrthoDesk, Objet24, , PolyJet, Objet Studio, Job Manager.

Microsoft and Windows XP are trademarks of Microsoft Corporation.

All names of products and services cited in this book are trademarks or registered trademarks of their respective companies.

## FCC Compliance

The equipment referred to in this guide has been tested and found to comply with the limits for a Class A device pursuant to part 15 of the FCC rules. These limits provide reasonable protection against harmful interference when the equipment is operated in a commercial environment. Stratasys 3D printing systems generate, use and can radiate radio-frequency energy and, if not installed and used in accordance with the instruction manual, may cause harmful interference to radio communications. Operation of this equipment in a residential area is likely to cause harmful interference, in which case the user will be required to correct the interference at his own expense.

The 3D printer referred to in this guide contains a transmitter module, FCC ID YH6-RFID.

**NOTE:** Stratasys is not responsible for radio or TV interference caused by unauthorized modification to this equipment. Changes or modifications not expressly approved by the manufacturer could void the user's authority to operate the equipment.

## Equipment Recycling



In the European Union, this symbol indicates that when the last user wishes to discard a product, it must be sent to appropriate facilities for recovery and recycling. For information about proper disposal, check your purchase contract, or contact the supplier of the equipment.

## Limitation of Liability

The product, software or services are being provided on an “as is” and “as available” basis. Except as may be stated specifically in your contract, Stratasys Ltd. expressly disclaims all warranties of any kind, whether express or implied, including, but not limited to, any implied warranties of merchantability, fitness for a particular purpose and non-infringement.

You understand and agree that Stratasys Ltd. shall not be liable for any direct, indirect, incidental, special, consequential or exemplary damages, including but not limited to, damages for loss of profits, goodwill, use, data or other intangible losses (even if Stratasys has been advised of the possibility of such damages), resulting from: (i) the use or the inability to use the product or software; (ii) the cost of procurement of substitute goods and services resulting from any products, goods, data, software, information or services purchased; (iii) unauthorized access to or alteration of your products, software or data; (iv) statements or conduct of any third party; (v) any other matter relating to the product, software, or services.

The text and drawings herein are for illustration and reference only. The specifications on which they are based are subject to change. Stratasys Ltd. may, at any time and without notice, make changes to this document. Stratasys Ltd., for itself and on behalf of its subsidiaries, assumes no liability for technical or editorial errors or omissions made herein, and shall not be liable for incidental, consequential, indirect, or special damages, including, without limitation, loss of use, loss or alteration of data, delays, or lost profits or savings arising from the use of this document.

## Patents

This product is covered by one or more of the following U.S. patents:

5,386,500

6,259,962

6,569,373

6,658,314

6,850,334

7,183,335

7,209,797

7,225,045

7,364,686

7,369,915

7,479,510

7,500,846

7,604,768

7,628,857

7,658,976

7,725,209

Stratasys Ltd.

<http://www.stratasys.com>

DOC-34025

Revision B

September 2016



# Contents

---

<b>1</b>	<b>About This Guide</b>	
	Using This Guide .....	1-2
	For More Information .....	1-2
	Terms Used in This Guide .....	1-3
<b>2</b>	<b>Safety</b>	
	Safety Features .....	2-2
	Symbols and Warning Labels .....	2-4
	Safety Guidelines .....	2-5
	Printer Installation .....	2-5
	Printer Operation .....	2-5
	UV Radiation .....	2-6
	Printer Maintenance .....	2-6
	Model and Support Materials .....	2-6
	UV Lamps .....	2-7
	First Aid for Working with Printing Materials .....	2-8
	Contact with Skin .....	2-8
	Contact with Eyes .....	2-8
	Ingestion .....	2-8
	Inhalation .....	2-9
	Waste Disposal .....	2-9
<b>3</b>	<b>Introducing the Objet30 3D Printing System</b>	
	Welcome to Objet Studio .....	3-2
	Work Configurations .....	3-2
	Source Files .....	3-4
	STL Files .....	3-4
	SLC Files .....	3-4
	Printing Materials .....	3-5
	Storage .....	3-5
	Shelf Life .....	3-5
	Exposure to Light .....	3-5
	Safety Considerations .....	3-6
	Disposal .....	3-6
	Work Environment .....	3-6
	Workstation Requirements .....	3-6
	Preparing Files for Use with PolyJet 3D Printing Systems .....	3-7
	Converting CAD Files to STL Format .....	3-7
	Converting CAD Files to SLC Format .....	3-8
	Objet Studio Software .....	3-9
<b>4</b>	<b>Installing Objet Studio</b>	
	How to Install Objet Studio .....	4-2
<b>5</b>	<b>Using Objet Studio</b>	
	Launching Objet Studio .....	5-3



Windows® 7 Security Warning .....	5-3
Objet Studio Interface .....	5-4
Ribbon Commands .....	5-6
Objet Studio Commands Menu .....	5-8
Model Tree Pane .....	5-8
Preparing Models for Production .....	5-9
OBJDF Files: Overview .....	5-9
Model Files .....	5-9
Placing Objects on the Build Tray .....	5-9
Opening Objet Tray Files .....	5-13
Quick-Access Model Commands .....	5-15
Selecting Objects .....	5-16
Copying and Pasting Objects .....	5-16
Surface Finish .....	5-17
Positioning Objects on the Build Tray .....	5-18
Automatic Orientation .....	5-18
Automatic Positioning .....	5-19
Manual Positioning .....	5-20
Manipulating Objects on the Tray .....	5-22
Positioning Objects on the Z-Axis .....	5-22
Valid Object Placement .....	5-23
Using a Grid to Position Objects .....	5-24
Measurement Units .....	5-25
Setting Model Dimensions .....	5-26
Repositioning Objects .....	5-26
Changing an Object's Orientation .....	5-28
Freezing Model Orientation .....	5-29
Display Options .....	5-30
Viewing Objects .....	5-30
Screen Layout .....	5-32
Tray Perspective .....	5-33
Setting Object Colors .....	5-35
Loading Large Files .....	5-35
Large File Manipulation .....	5-36
Zoom Options .....	5-38
Handling Trays .....	5-39
Tray Validation .....	5-39
Printing Modes .....	5-40
Production Estimates .....	5-41
E-mailing Objet Digital Files .....	5-41
Printing the Tray .....	5-41
Applying Additional Objet Studio Features .....	5-43
Dividing Objects .....	5-43
Choosing the Support Strength .....	5-44
“Hollow”— Filling Models with Support Material .....	5-45
Displaying the Cross Section of Objects .....	5-46
Saving the Screen Display as an Image File .....	5-47
Saving and Importing Build Trays .....	5-48
OBJTF Files .....	5-48
OBJZF Files .....	5-48
Customizing Objet Studio .....	5-49
Creating a Quick Access Toolbar .....	5-49

Hiding the Ribbon .....	5-51
Display Colors .....	5-51
Keyboard Shortcuts .....	5-53
Setting User Preferences .....	5-55
Professional Mode Features .....	5-56
Default Settings .....	5-57
OpenGL Driver Configuration .....	5-58
Getting Additional Objet Studio Assistance .....	5-60
Objet Studio Version, Material Module and Licensed Features .....	5-60
Monitoring and Managing Print Jobs .....	5-63
Job Manager Screen .....	5-64
Setting the Printer Connection .....	5-66
Off-line Mode .....	5-67
Setting the Remote Printer Connection (Client Mode) .....	5-71
Job Manager Commands .....	5-71
Configuring User Alerts .....	5-74
Printing from the Jobs Queue .....	5-75
Additional Server Features .....	5-76
Resuming Jobs .....	5-78

## 6 Operating and Maintaining the Objet30 3D Printer

Starting the Printer .....	6-3
Loading Model and Support Cartridges .....	6-5
Producing Models .....	6-7
Preparing the Printer .....	6-7
Printer Interface Color Key .....	6-10
Printing Indicators .....	6-11
Resuming Production After Printing has Stopped .....	6-12
Changing the Printing Material .....	6-14
Keeping the Printer in Idle Mode .....	6-20
Shutting Down the Printer .....	6-21
Shutdown Wizard .....	6-22
Material Flush/Fill Wizard .....	6-24
Maintaining the Printer .....	6-27
Routine Maintenance Schedule .....	6-27
Cleaning the Print Heads and the Roller .....	6-28
Cleaning and Replacing the Wiper .....	6-31
Pattern Test .....	6-33
Improving Print Quality .....	6-35
Cleaning and Replacing the Roller Waste Collector .....	6-36
Aligning the Print Heads .....	6-39
Optimizing (Calibrating) Print Heads .....	6-43
Replacing Print Heads .....	6-51
Testing and Calibrating the UV Lamp .....	6-62
Calibrating the Load Cells .....	6-65
Replacing the Odor Filter .....	6-67
Replacing the UV Lamp .....	6-68
Replacing the Material Filter .....	6-73
Replacing the Pump Tubes .....	6-82
Built-in Tests .....	6-93
Replacing the Waste Container .....	6-95
Cleaning the Exterior Panels .....	6-97

Backing-Up and Restoring Printer Settings .....	6-98
ReInitiate Wizard .....	6-98
Preventive Maintenance Tasks .....	6-98

## 7 Handling Printed Models

Removing Models After Printing .....	7-2
Removing the Support Material .....	7-2
Post-Printing Treatment for Models Made with VeroClear .....	7-5
Photo-Bleaching Instructions .....	7-5
Storing Models .....	7-6

# 1

## About This Guide

Using This Guide .....	1-2
For More Information .....	1-2
Terms Used in This Guide .....	1-3

## Using This Guide

This user guide provides instructions for installing, operating and maintaining Objet30 3D printing systems. It explains how to use features, and provides practical examples to guide you as you use the system.

The text and figures in this guide are based on the Objet30 3D printer, printer software version 33.2 and Objet Studio software version 9.2.

This document is meant to be used with Objet30 3D printers, running software version 33.2, and with Objet Studio software version 9.2.

This guide assumes that—

- all the hardware, software, and network components of your Objet30 system are installed, configured, and operating correctly.
- the operator has a working knowledge of the Windows® PC platform.

## For More Information

Visit <http://www.stratasys.com/> to download additional documents for this printer, including documents in other languages. Also available on this site: details about consumables and support contacts.

If you have any questions or comments about the way information is presented in this document, or if you have any suggestions for future editions, please send a message to [c-support@stratasys.com](mailto:c-support@stratasys.com).

## Terms Used in This Guide

<b>Build tray</b>	<p><i>In Objet Studio software:</i> The surface displayed on the screen that represents the actual build tray in the printer.</p> <p><i>In the printer:</i> The surface upon which models are produced.</p>
<b>Cleaning fluid</b>	Cleanser for flushing material feed tubes and the printing block, used to completely remove Model and Support material from the system before loading another type of material in the printer and before long-term shutdown. The cleaning fluid is supplied in standard material cartridges.
<b>Client/user workstation</b>	The workstation on which software is installed for preparing build trays for production on PolyJet printers. (There is no limit to the number of client workstations in the local network.)
<b>host/server workstation</b>	The workstation that interfaces directly with the Objet30 printer and is typically positioned next to it.
<b>Job Manager™</b>	The part of Objet Studio software that manages production jobs before they are sent to the PolyJet printer.
<b>Model material</b>	Material used for building models.
<b>Objet Studio™</b>	Software that prepares files for printing on Stratasys PolyJet printers.
<b>OBJTF</b>	The extension of a file that contains all of the information needed for a model-printing job on PolyJet 3D printers. An <i>objtf</i> file is used by Objet Studio to send a print job to a PolyJet 3D printer.
<b>OBJZF</b>	The extension of a compressed “wrapper” file containing all of the files used in an Objet Studio build tray. Using <i>objzf</i> files, a printing job can be saved as a single file, for convenient storage and transfer.
<b>Objet™ printer</b>	The Stratasys 3D printer referred to in this guide.
<b>Printer computer</b>	The computer inside the Objet30 printer that operates it.
<b>Printer interface</b>	The GUI (graphical user interface) used for controlling the Objet30 printer.
<b>Printer software</b>	Software running on the computer inside the Objet30 printer, that controls all printer operations.
<b>Resin</b>	The base substance from which photopolymer printing materials are made for use in Stratasys PolyJet printers. In Objet Studio and printer-application screens, “resin” refers to cartridges of model and support materials.
<b>SLC</b>	A file type used with Objet Studio, containing bitmaps of individual slices of the object.
<b>STL</b>	A file type used with Objet Studio software.
<b>Support material</b>	Material used for supporting the structure of models during production.

# 2

## Safety

Safety Features .....	2-2
Symbols and Warning Labels .....	2-4
Safety Guidelines .....	2-5
Printer Installation .....	2-5
Printer Operation .....	2-5
UV Radiation .....	2-6
Printer Maintenance .....	2-6
Model and Support Materials .....	2-6
UV Lamps .....	2-7
First Aid for Working with Printing Materials .....	2-8
Contact with Skin .....	2-8
Contact with Eyes .....	2-8
Ingestion .....	2-8
Inhalation .....	2-9
Waste Disposal .....	2-9

## Safety Features

Stratasys 3D printers are designed to comply with CE and FCC standards. They are equipped with the following safety features:

### Cover Interlock Switch

The power supplied to the UV lamp and the motion motors is turned off when the cover is opened.



#### Warning

**Do not defeat (override) the interlock switch.** Doing so could result in serious personal injury. If the interlock switch does not function correctly, do not use the printer, and contact your service provider.



#### Warning

**Do not defeat (override) the safety lock.** Doing so could result in serious personal injury. If the safety lock does not function correctly, do not use the printer, and contact your service provider.

### UV Screening

The transparent section of the cover blocks harmful UV radiation, allowing the operator to view the model as it is being made.

### Circuit Breaker

The power to the printer is turned off in case of electrical overcurrent.

**Note:** The circuit breaker is only accessible to service personnel.

### Grounded Chassis

The chassis of the printer is grounded, to prevent electrical shock.

**Note:** The power outlet must be properly grounded, in accordance with the local electric code, to provide this protection.









Figure 2-1 Front and back views of the Objet30 printer



If the Objet30 3D printing system is not used as specified in this guide, the safety features may not provide adequate protection.

## Symbols and Warning Labels

This following table lists the warning labels located on or in Objet30 printers.

Warning Symbol	Meaning	Location	Comments
	Hazard (general)	On the name plate on the back of the printer.	Read the instructions in this document before operating the printer.
	Hot surface	On the print block.	Risk of burns. Do not touch this surface after printing.
	High voltage	Near the UV lamp connector. Near the power-supply enclosures.	Risk of electric shock.
	Ultraviolet radiation	Near the UV lamp.	Risk of injury from ultraviolet radiation.
	Moving parts	On top of the printing assembly.	Risk of injury from moving parts.

## Safety Guidelines

The following general guidelines, together with the instructions provided throughout this user guide, ensure user safety while operating and maintaining the system. **If the system is not operated as specified, the user's safety may be compromised.**

### Printer Installation

- Installation and removal of the printer should only be done by qualified service personnel.
- Connect the printer (and the UPS unit) to the electric outlet using a power cord that is safety-certified.
- The electric outlet should be easily accessible, near the printer.
- Never connect the power plug to an outlet that does not have a ground (earth) wire, and never disconnect the ground. Doing so might expose the operator to serious danger from electric shock.
- The following safety statement is followed by translations to Finish, Norwegian, Swedish and Danish, as required by local regulations:  
“The machine must be connected to a grounded power outlet.”
  - FI: Laite on liitettävä suojakoskettimilla varustettuun pistorasiaan.
  - NO: Apparatet må tilkoples jordet stikkontakt.
  - SE: Apparatens skall anslutas till jordat uttag.
  - DK: Apparatets stikprop skal tilsluttes en stikkontakt med jord, som giver forbindelse til stikproppens jord.
- Leave a minimum of 20 centimeters between ventilation openings and walls or other objects.

### Printer Operation

- The printer should only be operated by persons trained by a Stratasys customer-support representative.
- All persons operating or maintaining the printer should know the location of first aid and emergency equipment and how to use it. **Never block access to this equipment.**
- Keep fingers and other body parts clear of the printer cover when closing it.
- Never attempt to open the printer cover while it is working.
- Never override the interlock safety switch.
- If the interlock safety switch ever fails, **do not use the printer.**
- Several parts of the printer remain extremely hot even after it has stopped operating. Avoid touching the UV lamp and the print block.

**UV Radiation** The UV lamp used in the printer emits dangerous radiation.

- If the UV lamp remains on when the printer cover is open, do not stare directly at the UV light. Shut down the printer and call your Stratasys service provider.

**Printer Maintenance**

- Service operations should be performed only by qualified personnel who have been instructed in relevant safety precautions.
- Notify co-workers and those who have access to the Objet30 system before beginning non-routine and hazardous work.



Report any potential dangers and safety-related accidents to your safety officer or to other appropriate authorities.

**Model and Support Materials**

Model and Support materials are made of chemical substances. Although precautions must be taken when handling these materials directly, all Model and Support materials used by the Objet30 system are handled in sealed cartridges. Normally, operators of the printer should never be directly exposed to hazardous materials. In the unlikely event of a leak or spill, follow the instructions that are included with the printing-material cartridge used.

- Store Model and Support materials indoors, in a dry area with adequate ventilation, between 15-25 degrees Celsius (59-77 degrees Fahrenheit). Never expose them to flames, heat, sparks, or direct sunlight.
- Keep Model and Support materials away from areas where food and drink are stored, prepared and consumed.
- Uncured printing material is considered a hazardous substance, requiring certain precautions when directly handling it. To prevent skin irritation, wear **neoprene** or **nitrile gloves**. If there is any chance that Model and Support materials might splash into the eyes, wear safety goggles. Prolonged direct contact with printing materials can cause an allergic reaction.
- When handling UV-cured models that may not be completely cured on the surface, common latex gloves are adequate.
- To prevent respiratory irritation, ventilate areas where Model and Support materials are used. The ventilation system should totally replace the air at least four times per hour.
- Clean up Model-material and Support-material spills with disposable towels or other absorbent, non-reusable material, such as sawdust or activated charcoal. Rinse the spill area with denatured or isopropyl alcohol (IPA), followed by soap and water. Dispose of the absorbent material in accordance with local regulations.
- Do not wash contaminated clothing at home; clothing should be professionally laundered.
- Dispose of contaminated shoes, belts and other leather items in accordance with any applicable regulations. Absorbed printing material may re-expose the user when these items are worn.

## UV Lamps

UV lamps used by the printer to cure printing materials contain a small amount of mercury. In the unlikely event of lamp breakage, avoid inhaling mercury vapor, and ventilate the room. If the lamp ruptures (breaks) during operation, leave the room and ventilate it thoroughly for about 30 minutes.

Use protective gloves to prevent contact with mercury and other lamp components. Carefully remove spilled mercury with a method that prevents the generation of mercury vapor, such as a syringe, packing tape or paper.

Place the broken lamp, mercury and contaminated materials in an air-tight, non-metallic container. Dispose of the container in accordance with applicable regulations.

## First Aid for Working with Printing Materials

In general, try to avoid direct contact with uncured printing material. If skin or eyes come into contact with it, wash the area immediately and thoroughly with water, and follow these first-aid instructions.



The Material Safety Data Sheet (MSDS) that accompanies printing materials contains important safety information. Keep this in an accessible place where these materials are used and stored.

### Contact with Skin

If uncured printing material comes in contact with skin, wash the affected area immediately and thoroughly with soap and cool water, then remove contaminated clothing. Pay particular attention to flushing the hair, ears, nose and other parts of the body that are not easily cleaned.

- Use cool water to prevent skin pores from opening, so that the liquid material does not easily penetrate the skin.
- Do not use solvents to clean skin.
- If large areas of skin have been exposed, or if prolonged contact results in blisters, seek medical attention. In any case, if irritation persists, seek medical attention.
- Avoid the accidental transfer of printing material from the hands to other areas of the body, especially to the eyes.
- If protective cream was used, do not reapply it until the skin has been completely cleansed.

### Contact with Eyes

If uncured printing material comes in contact with the eyes, flush immediately with large amounts of water for 15 minutes and seek medical attention.

- Avoid sunlight, fluorescent light, and other sources of ultraviolet radiation.

Wearing contact lenses when handling liquid printing materials is not recommended. If the liquid splashes into the eyes when contact lenses are worn, immediately remove the lenses and flush the eyes with water.

- Clean and disinfect the contaminated lenses.
- Do not wear contact lenses until eye irritation disappears.

### Ingestion

If printing material is swallowed, refer to the instructions included with the cartridge. **Seek medical attention immediately.**

## Inhalation

Vapors from printing materials can be irritating to the respiratory system. If respiratory irritation occurs, expose the victim to fresh air immediately.

- If the victim has stopped breathing, perform artificial respiration or cardiopulmonary resuscitation.
- Seek medical attention immediately.
- Keep the victim warm but not hot.
- Never feed anything to an unconscious person.
- Oxygen should be administered by authorized personnel only.

## Waste Disposal

Fully cured printed models can be disposed of as ordinary office trash. However, special care is required when handling printer waste (uncured printing material).

- Printing Materials
- When removing the waste container from the Objet30 printer, wear neoprene or nitrile gloves.
  - To prevent liquid waste from splashing into the eyes, wear safety goggles.
  - Liquid waste from the Objet30 printer is classified as hazardous industrial waste. Therefore, printing-material waste must be packaged and disposed of in a manner that prevents human contact with it and contamination of water sources.
  - Empty Model-material and Support-material cartridges contain residue of their contents. Some leakage of this residue may occur through the broken cartridge seal. Therefore, handle and store empty cartridges with care.
  - Do not attempt to reuse empty cartridges, and do not puncture them.
  - Dispose of used cartridges and waste containers in accordance with local regulations.
  - Discard contaminated clothing, shoes, empty containers, etc., in accordance with any applicable regulations.

- UV Lamps
- UV lamps used by the printer to cure printing materials contain a small amount of mercury, and are considered “Universal Waste.” Recycle or discard used lamps in accordance with applicable regulations.

### Broken lamps:

After ventilating the area, use protective gloves and carefully remove spilled mercury with a method that prevents the generation of mercury vapor, such as a syringe, packing tape or paper. Place the broken lamp, mercury and contaminated materials in an air-tight, non-metallic container. Dispose of the container in accordance with applicable regulations.

# 3

## Introducing the Objet30 3D Printing System

Welcome to Objet Studio .....	3-2
Work Configurations .....	3-2
Source Files .....	3-4
STL Files .....	3-4
SLC Files .....	3-4
Printing Materials .....	3-5
Storage .....	3-5
Shelf Life .....	3-5
Exposure to Light .....	3-5
Safety Considerations .....	3-6
Disposal .....	3-6
Work Environment .....	3-6
Workstation Requirements .....	3-6
Preparing Files for Use with PolyJet 3D Printing Systems	3-7
Converting CAD Files to STL Format .....	3-7
Converting CAD Files to SLC Format .....	3-8
Objet Studio Software .....	3-9



## Welcome to Objet Studio



Figure 3-1 The Objet30 3D Printer

## Work Configurations

The Objet30 3D printing system can be set up as a single-station system or as a multi-station system. When connected to a local computer network, the system can serve multiple users. In such configurations, each user workstation (client) prepares files for production. A server, typically next to the 3D printer, sends jobs to the printer for production.

Figure 3-2 shows the Objet30 printer set up in a multi-client configuration.

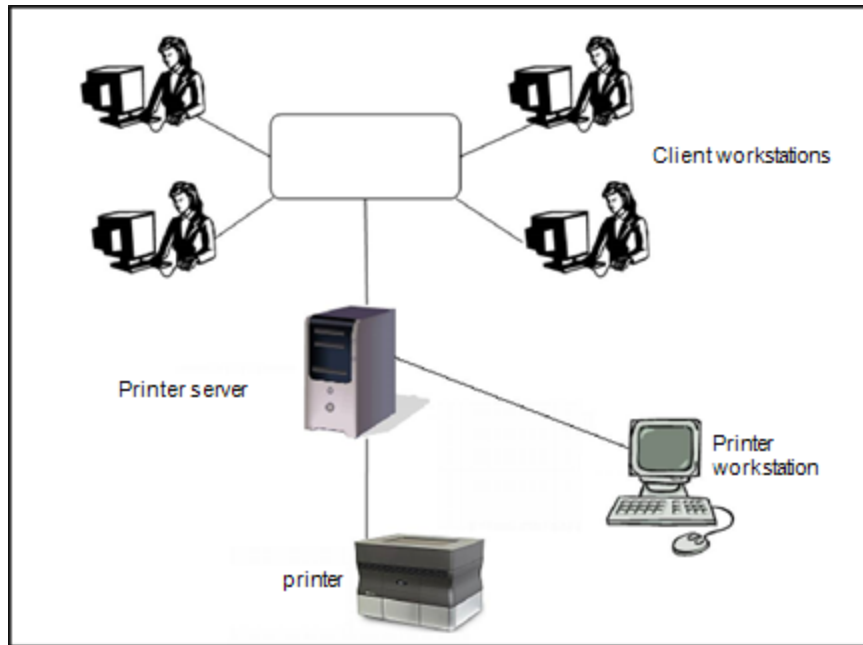

Figure 3-2 Multi-client network configuration

When jobs are sent to the printer, Job Manager, on the server computer, arranges them according to their priorities, model-material type, and other factors. In multi-workstation configurations, the operator of the server—typically the production administrator—has total control over the jobs sent to the printer, and can prioritize jobs, delete jobs, review job history and reprint jobs.

## Source Files

PolyJet printing systems produce three-dimensional models designed with most CAD tools and some other 3D applications. Supported file formats:

- [STL](#)
- [SLC](#)

Objet30 systems feature the capability of producing different types of model files simultaneously.

### STL Files

STL is short for *Standard Triangulation Language*. This language views any object as a collection of surfaces, and describes each surface of the object as a collection of triangles.

For example, a square can be described as two triangles; a cube (six squares) as 12 triangles. Curved surfaces need more triangles to describe them. The higher the tolerance (for smooth surfaces), the more triangles are needed. The result is that high-quality object descriptions mean very heavy files.

Most CAD software can export STL files. The Objet30 system utilizes these files for building models (rapid prototyping), and also for directly making molds for mass-producing items.

STL files can be ASCII (text) files or binary files. The content of the ASCII file begins with “solid” and ends with “end-solid” (both lower case). Between these keywords is a list of the triangles that describes the faces of the solid model. Each triangle defines a single normal vector directed away from the solid’s surface, followed by its X-Y-Z coordinates. These are expressed as Cartesian coordinates and are floating-point values. The coordinates of all triangles should be positive and should fall within the volume of the model.

### SLC Files

SLC is short for *Stereo-Lithography Contour*. SLC files describe two-dimensional contours of the three-dimensional models. These contour lines are polylines.

SLC files are ASCII (text) files that save models as a series of slices. This means that models based on SLC files cannot be orientated; only their scale (size) and position on the build tray can be controlled. For this reason, the model’s orientation must be suitable for production before it is saved as an SLC file. Because of the nature of SLC files, the appearance of models in Objet Studio may be different than the solid-object images displayed from STL files.

## Printing Materials

Objet30 printers produce models by jetting thin layers of printing materials on the build tray, until the complete model is formed. Two types of material are used in this process:

- *Model* material—which makes up the finished model
- *Support* material—which fills gaps and spaces in the model during printing, and is removed after printing



For up-to-date information about PolyJet printing materials and their properties, go to <http://www.stratasys.com/materials/polyjet>.

### Storage

Materials used for printing models with Objet30 printers are made of resins, which are composed of reactive monomers and oligomers. Although printing materials are supplied in sealed, UV-proof cartridges, care must be taken when storing and handling them. Follow these guidelines to protect operators and the environment, and to ensure optimum results.

- To ensure product stability, do not allow these materials to come into contact with metal. Plastics made from monomer-soluble substances (such as polystyrene or polyvinyl chloride) are not suitable for storing PolyJet printing materials.
- When not in use, keep material cartridges tightly sealed to prevent contamination, the effects of exposure to UV radiation, and accidental spillage.
- Store material cartridges indoors, in a dry area with adequate ventilation, between 15–25 degrees Celsius (59-77 degrees Fahrenheit). If exposed to heat or flames, cartridges might burst or ignite.
- Signs of premature polymerization in material cartridges include bulging, leaking, the emission of heat, and unusual odor. Exposure to heat can cause resin to gel in the cartridges.
- Make sure that material cartridges are stored in accordance with all local regulations and other applicable requirements.

### Shelf Life

Materials used for producing models have a limited shelf life. The expiry date on the label is valid when properly stored in an undamaged, unopened cartridge. Always rotate your stock, so that the cartridge with the earliest date is used first.

### Exposure to Light

If printing materials are not in their sealed cartridges, make sure to shield them from sunlight and other sources of UV radiation, such as fluorescent and mercury-vapor lights. Exposure to UV radiation causes an increase in viscosity and, eventually, solidification.

**Safety Considerations** Before being cured, resins are hazardous materials. To prevent possible health hazards, follow these precautions regarding printing materials:

- Do not expose to flames, heat or sparks.
- Prevent contact with skin and eyes.
- Ventilate areas where they are handled.
- Keep them separate from food and drink.

Cured plastic parts, however, are safe. They can be handled and stored without precautions.



You can find more safety information about resins in:

- "Safety Guidelines" on page 2-5
- "First Aid for Working with Printing Materials" on page 2-8

**Disposal** Dispose of cartridges of model and support material in accordance with all applicable laws and regulations. If necessary, the cartridges can be disassembled for recycling.

## Work Environment

Extreme heat and humidity conditions can adversely affect the operation of the Objet30 3D printer. Use ventilation or air-conditioning systems, if necessary, to keep the work area within the following ranges:

- 18°–25°C (64°–77°F)
- 30%–70% relative humidity

## Workstation Requirements

The requirements for client computers running PolyJet Studio are listed in the Objet30 Site Preparation Guide.

To download this document, go to: [www.stratasys.com/customer-support/customer-resource-center/polyjet-customer-documents](http://www.stratasys.com/customer-support/customer-resource-center/polyjet-customer-documents)

## Preparing Files for Use with PolyJet 3D Printing Systems

Before using design files with Stratasys 3D printing systems, make sure that they are in a supported file format. (For an explanation of these file formats, see "Source Files" on page 3-4.)

You can print several models or parts at the same time, after arranging them on the build tray in Objet Studio. The following are the maximum dimensions for a single model printed on the Objet30 printer:

- *With glossy finish*—
  - X-axis: 294.00 mm (11.57 inches)
  - Y-axis: 192.00 mm (7.55 inches)
  - Z-axis: 148.60 mm (5.85 inches)\*
    - \* OrthoDesk printers—100.0 mm (3.94 inches)
- *With matte finish*—
  - X-axis: 293.00 mm (11.53 inches)
  - Y-axis: 191.00 mm (7.52 inches)
  - Z-axis: 148.30 mm (5.83 inches)\*
    - \* OrthoDesk printers—97.9 mm (3.85 inches)

### Converting CAD Files to STL Format

This procedure may vary slightly, depending on the CAD software used, but the following instructions generally apply.

To convert a file to STL format (in a CAD program):

1. From the File menu, select **Save As**.
2. In the *Save As* dialog box, open the *Save As Type* drop-down list and select \*.STL.
3. Click **Options** and set the following parameters:
  - Total Quality**—approximately 0.01 mm (deviation tolerance / linear-dimension tolerance)
  - Detail Quality**—approximately 5° (angle tolerance)

**Note:** Lowering these values produces more accurate models, but results in larger files and longer loading and processing times. For this reason, it is generally not recommended that you use lower values.
4. In the file format option, choose *binary* or *ASCII*. (Both binary and ASCII formats can be used in Objet Studio. However, binary files are smaller, so this option is recommended.)
5. Click **OK** or **Save**.

After converting the model files, it is recommended that you check them for defects in an STL-repair application (such as Magics™, by Materialise®) before opening them in Objet Studio and producing the model.



For more information, download [From CAD to Objet Studio Workflow for PolyJet Technology](#).

**Converting  
CAD Files to  
SLC Format**

When converting files to SLC format, it is recommended that you set a layer thickness of 15 microns (0.015 mm). Since SLC files cannot be orientated in Objet Studio, it is important that models are properly orientated before being saved as SLC files. Considerations for suitable model orientation are explained in "Manual Positioning" in Chapter 3 on page 5-20.

## Objet Studio Software

The Objet Studio program for the Objet30 3D printing system consists of two main screens:

- Tray Settings / Model Settings
- Job Manager

### Tray Settings / Model Settings

In the *Tray Settings* and *Model Settings* screens, you prepare source files for production in Objet30 3D printers. Objet Studio offers you a wide variety of file-preparation options, but always consists of the following basic procedure:

1. Placing one or more objects on the *build tray*
2. Positioning the object(s) on the tray
3. Configuring object and tray parameters
4. Saving the tray configuration as an *objtf* (tray format) file
5. Sending the *objtf* file to the Objet30 3D printer for production

Using Objet Studio to perform these tasks is described in detail in Chapter 5, "Using Objet Studio".

### Job Manager

The *Job Manager* screen is different for client workstations and for the computer connected directly to the Objet30 3D printer.

- In Objet Studio installed on the directly-connected computer (server), the *Job Manager* screen displays the queue and status for all jobs sent to the 3D printer by the server itself and by all client computers on the network. All jobs displayed can be edited and manipulated.
- In Objet Studio installed on client computers, the Job Manager screen displays the queue and status only for jobs sent to a 3D printer server from that computer. Only these jobs can be edited and manipulated from the client computer.



Client computers can be connected, via the local network, to PolyJet 3D printers, but only to one at a time. The *Job Manager* screen displays the status of the 3D printer to which the client is currently connected.



# 4

## Installing Objet Studio

How to Install Objet Studio ..... 4-2

## How to Install Objet Studio

Objet Studio software is installed during printer installation. This section is provided in case you need to reinstall Objet Studio, or install it on a remote (client) computer.

The Objet Studio setup wizard guides you when installing this software. Objet Studio is installed on the printer-server (“host”) computer, but it can also be installed on remote, “client” computers and on computers used to prepare files for printing models, or for training and demonstration purposes. During installation, you choose to install either the printer-server (“host”) application or the client application.

To install Objet Studio software:

1. Connect the USB flash drive (supplied with the printer) to a USB port.
2. On the USB flash drive navigate to the Objet Studio installation file, and run it.
3. To install Objet Studio, you must agree to the license agreement. After reading its terms, click **Yes** to continue, or **No** to close the wizard.

If you click **Yes**, the following screen should appear.

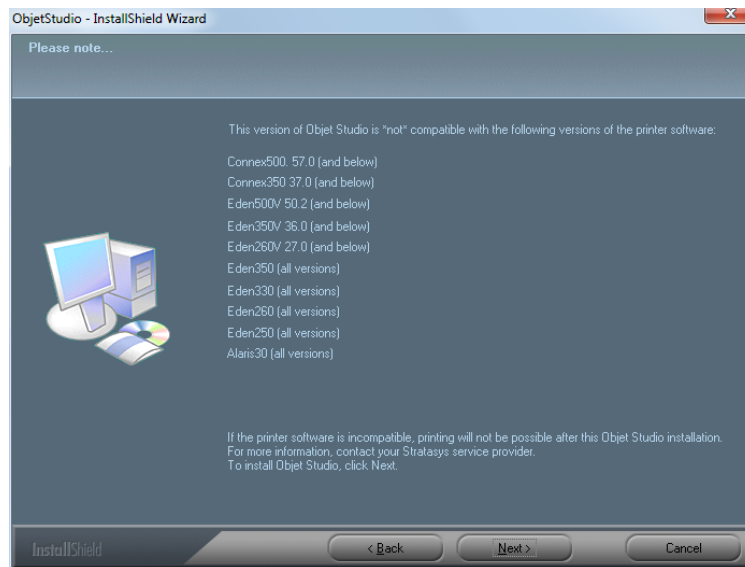

Figure 4-1 Objet Studio compatibility check

4. Make sure that your printer is compatible with Objet Studio by checking the list displayed.

**Note:** The printers displayed are legacy printers that are **not** compatible with this version of Objet Studio.

5. In the *Installation type* screen, select the required installation option.  
Select *Objet Studio for a Server computer*—
  - if you are installing *Objet Studio* on the server (“host”) computer—the computer directly connected to an *Objet30* printer.
  - if you are installing *Objet Studio* on a standalone (off-line) computer.Select *Objet Studio for Client workstations* if you are installing *Objet Studio* on a “client” workstation—a remote computer that prepares print jobs and then sends them to a server computer.

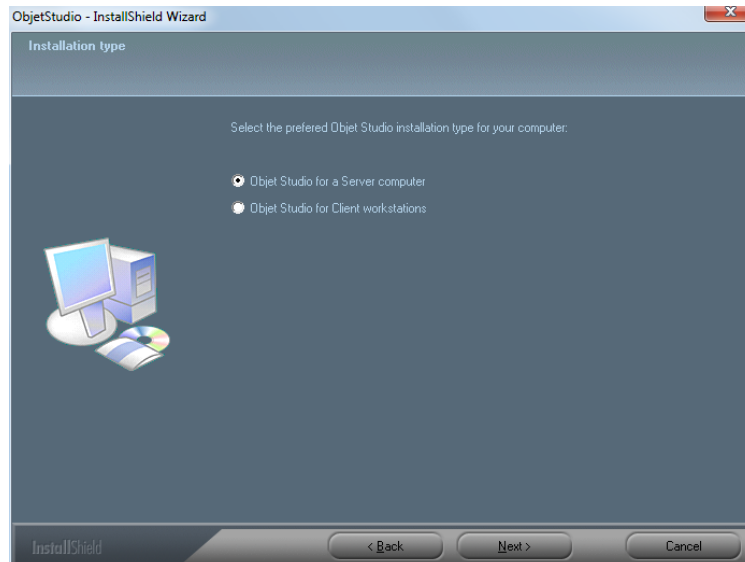

Figure 4-2 *Objet Studio* configuration selection

6. In the *Choose Destination Location* screen, verify the destination folder and click *Next*.

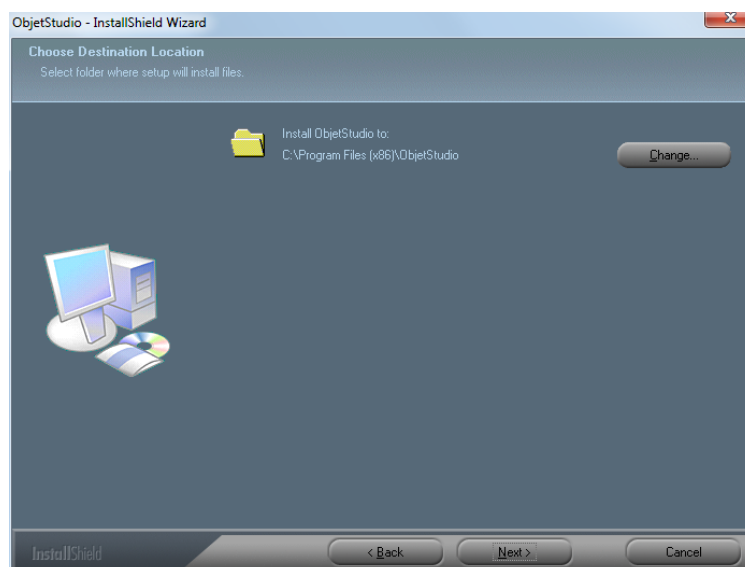

Figure 4-3 *Objet Studio* installation-folder selection



It is recommended that you do not change the default destination folder.

7. In the *Select Printer Type* screen, select the 3D printer used for producing models and click Next.

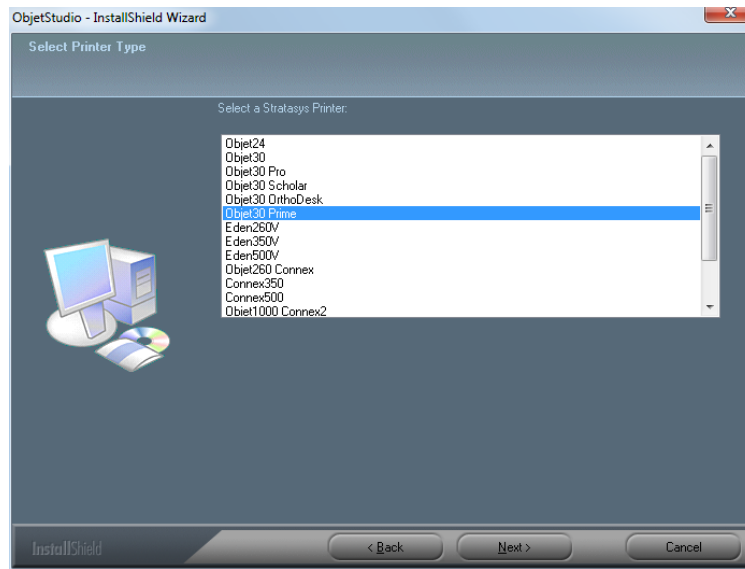

Figure 4-4 Printer selection



- For Alaris30U printers, select **Objet30**
- For Alaris30 Pro printers, select **Objet30Pro**
- For Objet30 Dental Prime, select **Objet30 Prime**

8. When the following screen appears, click **Install** to begin installation.

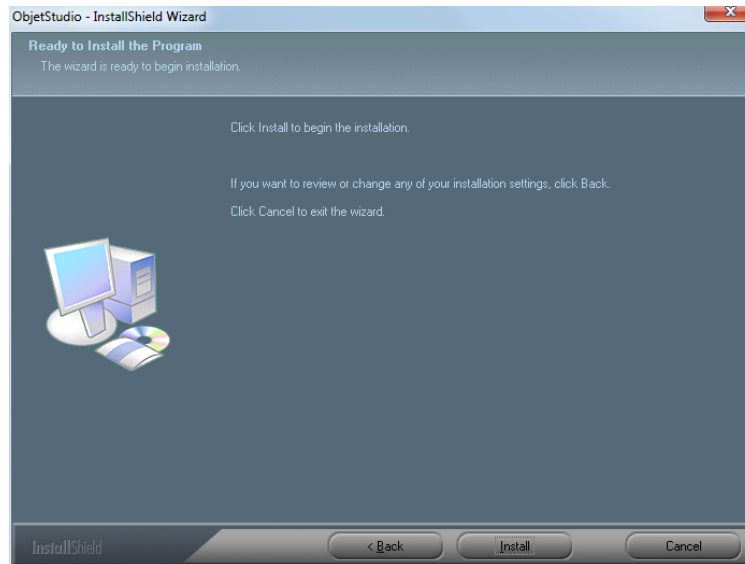

Figure 4-5 *Ready to Install* screen

After clicking **Install**, a progress bar shows the progress of the installation process.

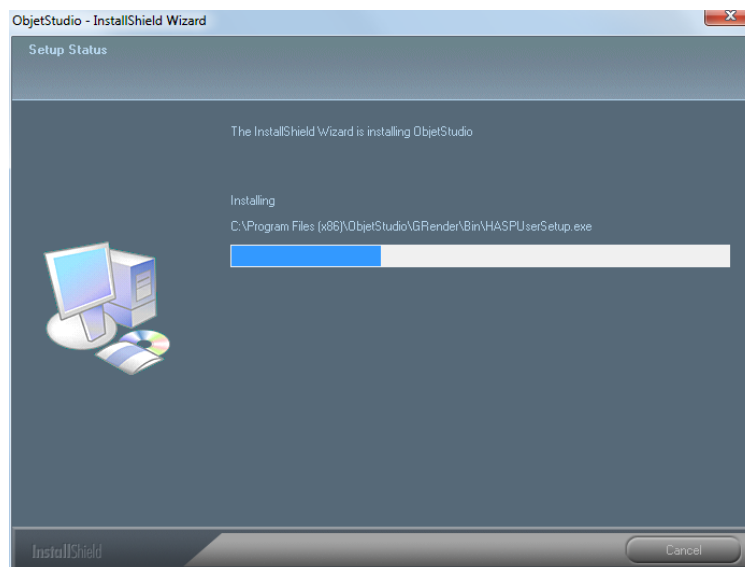

Figure 4-6 Installation progress bar



Objet Studio requires that Microsoft® DirectX® is installed on the computer. If necessary, an installation screen for this program will appear. To continue with Objet Studio installation, accept the DirectX agreement.

When installation is complete, the final InstallShield wizard screen appears.

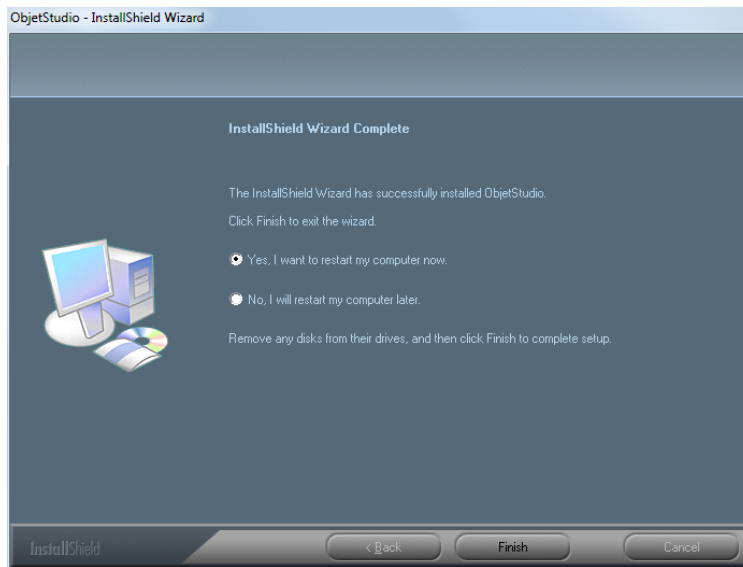

Figure 4-7 Final installation screen

9. To complete the software installation, click Finish.

The installation process ends when the appropriate icon(s) appear on the computer desktop:

- Objet Studio
- Stop Job Manager (for servers and standalone stations)

## How to Uninstall Objet Studio

If there is ever a need to uninstall the Objet Studio software, do **not** attempt to do so from the Windows Control Panel. (This does not completely remove all software components.) Instead—

- From the *Start* menu, select All Programs > Stratasy > Uninstall Objet Studio.

# 5

## Using Objet Studio

<b>Launching Objet Studio</b> .....	<b>5-3</b>
Windows® 7 Security Warning .....	5-3
Objet Studio Interface .....	5-4
Ribbon Commands .....	5-6
Objet Studio Commands Menu .....	5-8
Model Tree Pane .....	5-8
<b>Preparing Models for Production</b> .....	<b>5-9</b>
OBJDF Files: Overview .....	5-9
Model Files .....	5-9
Placing Objects on the Build Tray .....	5-9
Opening Objet Tray Files .....	5-13
Quick-Access Model Commands .....	5-15
Selecting Objects .....	5-16
Copying and Pasting Objects .....	5-16
Surface Finish .....	5-17
<b>Positioning Objects on the Build Tray</b> .....	<b>5-18</b>
Automatic Orientation .....	5-18
Automatic Positioning .....	5-19
Manual Positioning .....	5-20
<b>Manipulating Objects on the Tray</b> .....	<b>5-22</b>
Positioning Objects on the Z-Axis .....	5-22
Valid Object Placement .....	5-23
Using a Grid to Position Objects .....	5-24
Measurement Units .....	5-25
Setting Model Dimensions .....	5-26
Repositioning Objects .....	5-26
Changing an Object's Orientation .....	5-28
Freezing Model Orientation .....	5-29
<b>Display Options</b> .....	<b>5-30</b>
Viewing Objects .....	5-30

Screen Layout .....	5-32
Tray Perspective .....	5-33
Setting Object Colors .....	5-35
Loading Large Files .....	5-35
Large File Manipulation .....	5-36
Zoom Options .....	5-38
<b>Handling Trays .....</b>	<b>5-39</b>
Tray Validation .....	5-39
Printing Modes .....	5-40
Production Estimates .....	5-41
E-mailing Objet Digital Files .....	5-41
Printing the Tray .....	5-41
<b>Applying Additional Objet Studio Features .....</b>	<b>5-43</b>
Dividing Objects .....	5-43
Choosing the Support Strength .....	5-44
“Hollow”— Filling Models with Support Material .....	5-45
Displaying the Cross Section of Objects .....	5-46
Saving the Screen Display as an Image File .....	5-47
Saving and Importing Build Trays .....	5-48
OBJTF Files .....	5-48
OBJZF Files .....	5-48
<b>Customizing Objet Studio .....</b>	<b>5-49</b>
Creating a Quick Access Toolbar .....	5-49
Hiding the Ribbon .....	5-51
Display Colors .....	5-51
Keyboard Shortcuts .....	5-53
Setting User Preferences .....	5-55
<b>Professional Mode Features .....</b>	<b>5-56</b>
Default Settings .....	5-57
OpenGL Driver Configuration .....	5-58
<b>Getting Additional Objet Studio Assistance .....</b>	<b>5-60</b>
<b>Objet Studio Version, Material Module and Licensed Features .....</b>	<b>5-60</b>
<b>Monitoring and Managing Print Jobs .....</b>	<b>5-63</b>
Job Manager Screen .....	5-64
Setting the Printer Connection .....	5-66
Off-line Mode .....	5-67
Setting the Remote Printer Connection (Client Mode) .....	5-71
Job Manager Commands .....	5-71
Configuring User Alerts .....	5-74
Printing from the Jobs Queue .....	5-75
Additional Server Features .....	5-76
Resuming Jobs .....	5-78



## Launching Objet Studio

After you install Objet Studio, a launch icon  appears on the Windows desktop. Open the application by double-clicking this icon, or by selecting Objet Studio from the Start menu.

### Windows® 7 Security Warning

Depending on the User Account Control settings in Windows® 7, you might see the following warning when opening Objet Studio.

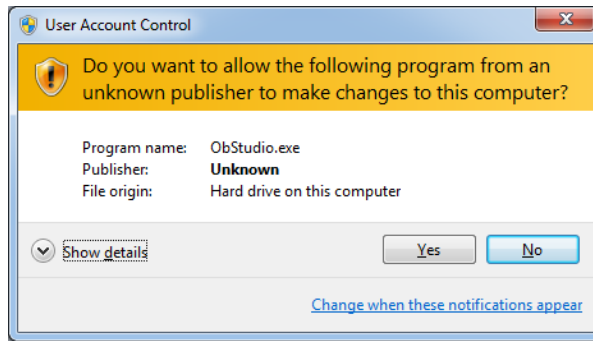

Figure 5-1 Security Warning

If you click Yes, Objet Studio opens. However, this warning message will appear each time you open the program, unless you change the User Account Control settings.

To prevent the warning message from appearing again:

1. Click the link at the bottom of the security warning dialog box (Change when these notifications appear).
2. In the *User Account Control Settings* screen, move the slider to Never notify.

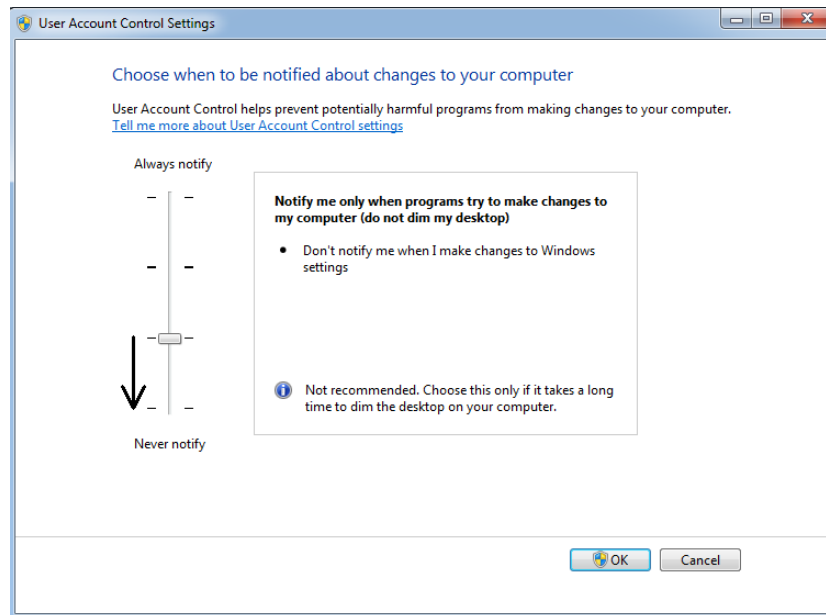

Figure 5-2 Changing the User Account Control settings

3. Click OK.
4. In the following dialog box, click Yes.

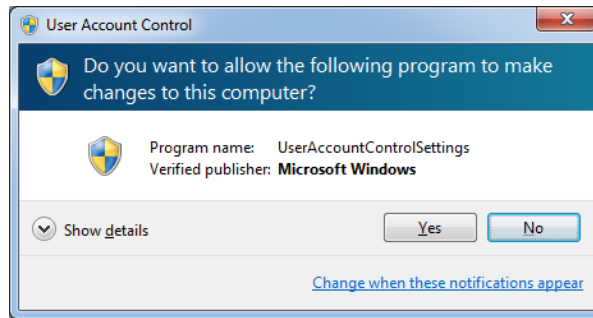

Figure 5-3 Confirming the change in the User Account Control settings

## Objet Studio Interface

When Objet Studio opens, the *Tray Settings* screen appears, showing an empty build tray.

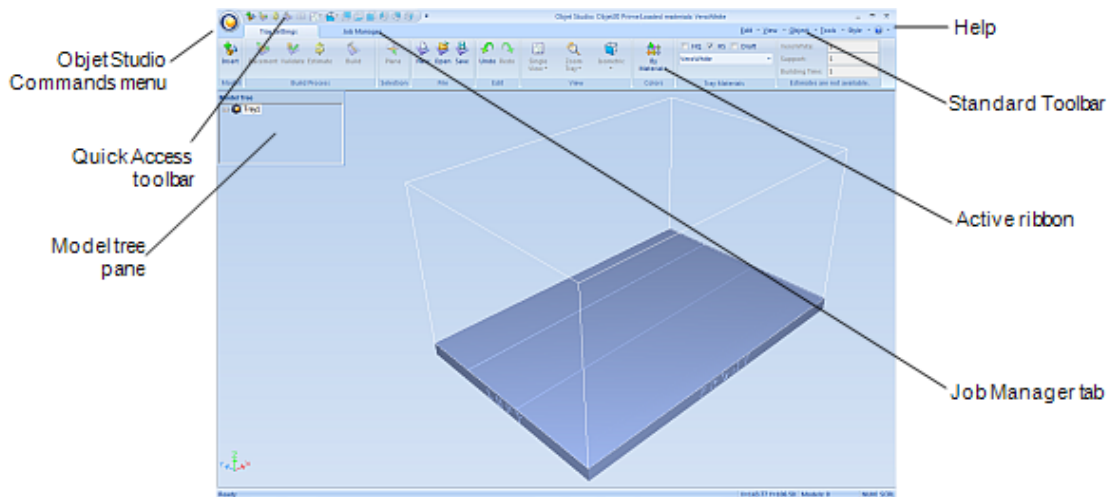

Figure 5-4 Objet Studio opening screen

The Objet Studio interface consists of two main screens:

- **Tray Settings**—for arranging models and preparing them for printing.
- **Job Manager**—for monitoring and managing print jobs.

This screen is described in "Monitoring and Managing Print Jobs" on page 5-63.

Each screen is controlled by menus and icons on its own ribbon. An additional ribbon, *Model Settings*, displays controls for configuring and manipulating selected models.

Objet Studio anticipates your workflow by displaying and enabling the options relevant to your current task. For example, when you first open Objet Studio, the *Model Settings* ribbon is disabled until you place a model on the build tray. Similarly, options available from the standard toolbar menus are enabled or disabled to match the current workflow.

The ribbon, colors used, and several other interface features can be customized. How to change the appearance of the interface is explained in "Customizing Objet Studio" on page 5-49.



Instructions for using the commands for preparing models for production and sending jobs to the printer, appear later in this chapter.

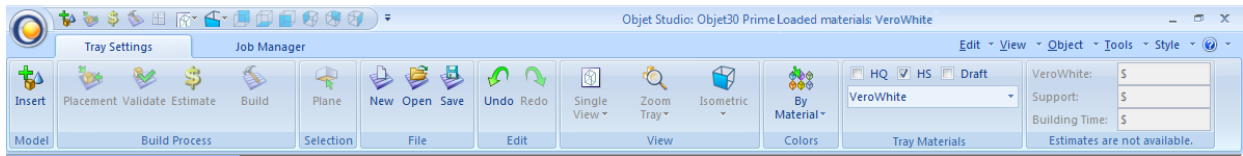

Figure 5-5 Tray Settings ribbon

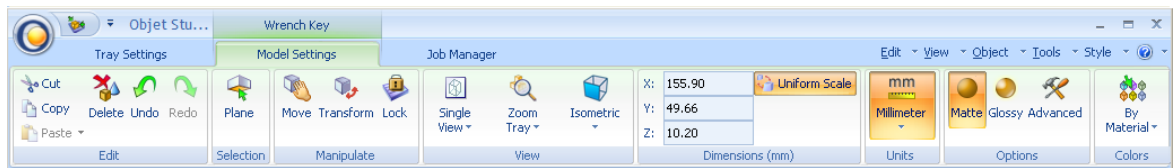

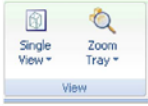

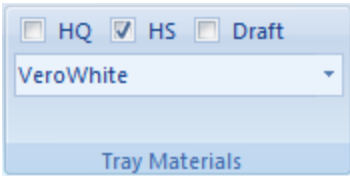

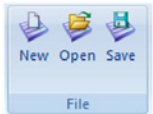
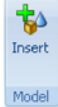
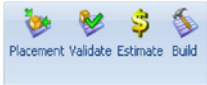

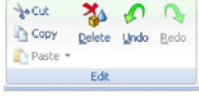
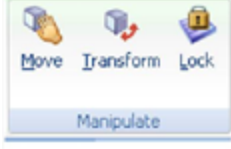
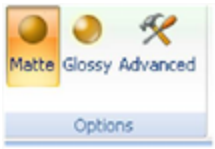



Figure 5-6 Model Settings ribbon

## Ribbon Commands

The following table lists the *Tray Settings* and *Model Settings* ribbon command groups, and shows when they are enabled, and where they appear.

Group	Purpose	When enabled	Tray Settings Ribbon	Model Settings Ribbon
	Setting display colors.	Always.	✓	✓
	Selecting perspective and zoom level.	Models are on the build tray.	✓	✓
	Choose to select a plane.	Models are on the build tray.	✓	✓
	Change the perspective of the active pane.	Models are on the build tray.	✓	✓
	Assigning printing material.	Build tray is empty. Models are not selected.	✓	
	Undoing or redoing actions.	After an action or object selection.	✓	✓
	Estimating the amount of printing materials required.	Build tray is not empty.	✓	
	Opening and saving files.	Models are not selected.	✓	
	Placing model files on the build tray.	Always.	✓	

Group	Purpose	When enabled	Tray Settings Ribbon	Model Settings Ribbon
	Pre-build/build commands.	Models are on the build tray.	<input checked="" type="checkbox"/>	
	Setting model dimensions.	A model is selected.		<input checked="" type="checkbox"/>
	Cutting, copying, pasting and deleting models.	A model is selected.		<input checked="" type="checkbox"/>
	Moving, rotating and resizing models.	A model is selected.		<input checked="" type="checkbox"/>
	Assigning model finish and setting support strength/“hollow.”	A model is selected.		<input checked="" type="checkbox"/>
	Setting a model’s unit of measure (millimeters or inches).	A model is selected.		<input checked="" type="checkbox"/>



To quickly identify an icon, move the cursor over it to display a tooltip. The “Undo” and “Redo” tooltips change to reflect your last Objet Studio action.



After activating some of the ribbon commands (by clicking them), they remain active until you click another button or until you press the Escape key.

### Objet Studio Commands Menu

Clicking the  icon in the upper-left corner opens the Objet Studio Commands menu. This menu displays basic application commands and options.

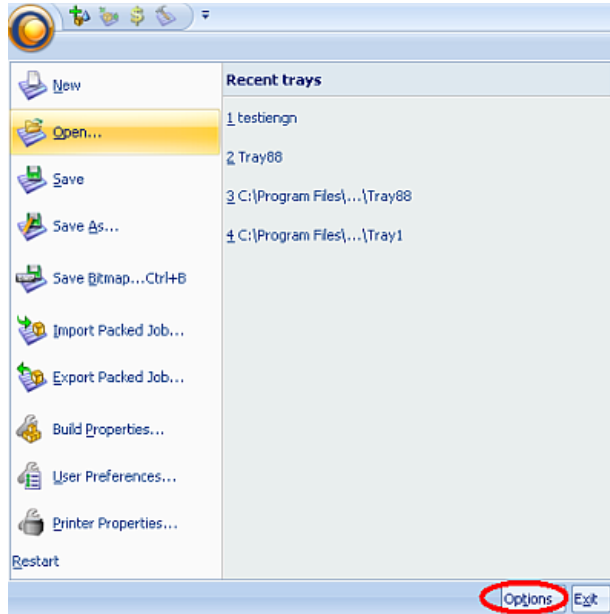

Figure 5-7 Objet Studio Commands menu

The *Options* button opens a dialog box for customizing Objet Studio.

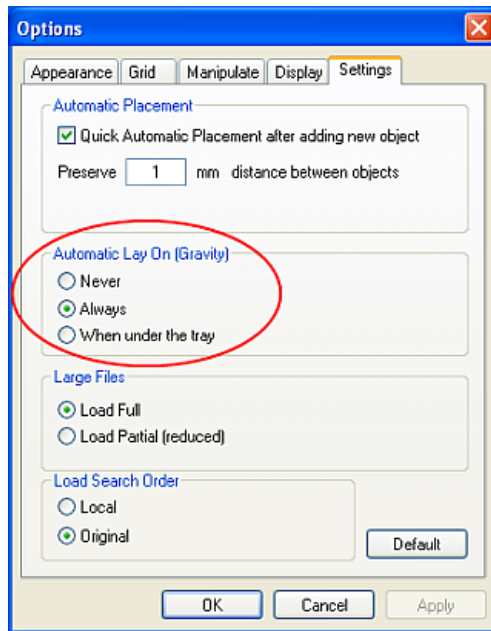

Figure 5-8 *Options* dialog box

### Model Tree Pane

The *Model Tree* pane lists the objects placed on the build tray. By default, the pane “floats”— that is, you can move it to another position on the screen and resize it. Alternatively, you can fix its position at the left of the application window, and even hide it.

## Preparing Models for Production

Model preparation involves the following basic steps:

1. Place objects on the build tray.
2. If necessary, manipulate the object's orientation and position.
3. Select the material and model finish.

### OBJDF Files: Overview

An *objdf* file describes both the geometry of a single object and the material, and finish required to print it.

You can use this file format to save a group of separate objects on the build tray as one unit, together with their relative positions and material.

Further explanations of *objdf* files, and their features, appear throughout this chapter.

### Model Files

To produce models, you open one or more model files in Objet Studio and position objects on the build tray. You can place objects on the build tray in two ways: You can place objects on the build tray in several ways:

- by inserting individual *stl* files.
- by pasting objects that you copied to the Windows clipboard.

If you know what type of model material will be used to produce the models, make sure it is selected from the material drop-down menu.

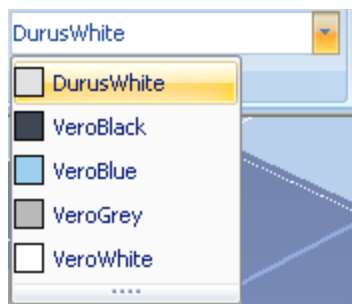

Figure 5-9 Model material selection toolbar

**Note:** It is not necessary to select the Model material now, but it is recommended—each type of material has unique characteristics that may affect the valid positioning of objects on the build tray. The material selected can also affect printing time—printing with Objet VeroClear takes longer than printing with other materials.

### Placing Objects on the Build Tray

To place an object on the build tray:

1. Open the *Insert* dialog box—
  - From the *Object* menu, select *Insert*.

or—

- On the *Tray Settings* ribbon, click  *Insert*.

or—

- Right-click on the build tray, and select *Insert* from the context menu.

The *Insert* dialog box appears.

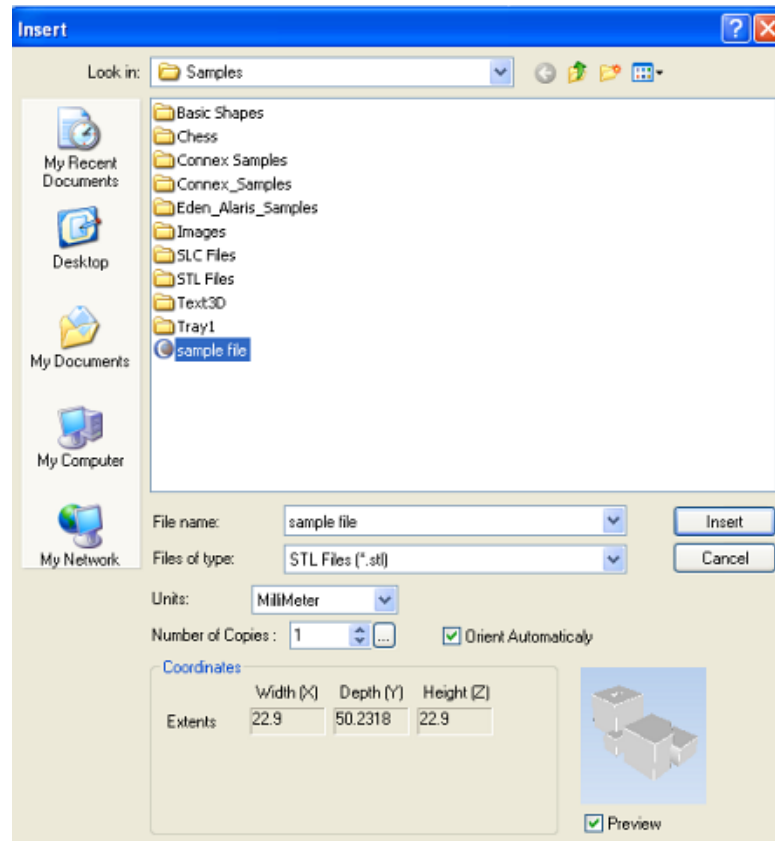

Figure 5-10 *Insert* dialog box

2. In the *Look in* field, display the appropriate folder.
3. In the *Files of type* field, select the file type to display.
4. Select the desired file, and make sure that it appears in the *File name* field. If the *Preview* check box is selected, the object is displayed in the dialog box, as shown in Figure 5-10.

The *Model Settings* ribbon is displayed when objects are placed on the build tray.

5. Select any of the following options, as required:
  - Units**—*Millimeters* or *inches* for the object's units of measure.  
The 3D file contains the object's proportions, but not its units of measure. Therefore, make sure to correctly select either millimeters or inches when inserting an object. Otherwise, the size of the object on the build tray will be either much too large or much too small. To change the measurement units of objects already placed on the tray, see "Measurement Units" on page 5-25.
  - Number of copies**—How many copies of this object to place on the build tray.
  - Orient Automatically**—Automatically orient objects on the build tray for efficient model building.

**Note:** The Extents values displayed in the *Coordinates* section of the *Insert* dialog box, represent the maximum dimensions of the object on each axis.



These dimensions correspond to the virtual “bounding box” surrounding the object see Figure 5-36 on page 5-31).

6. Click Insert.

Objet Studio places the object on the build tray, and in the model tree.

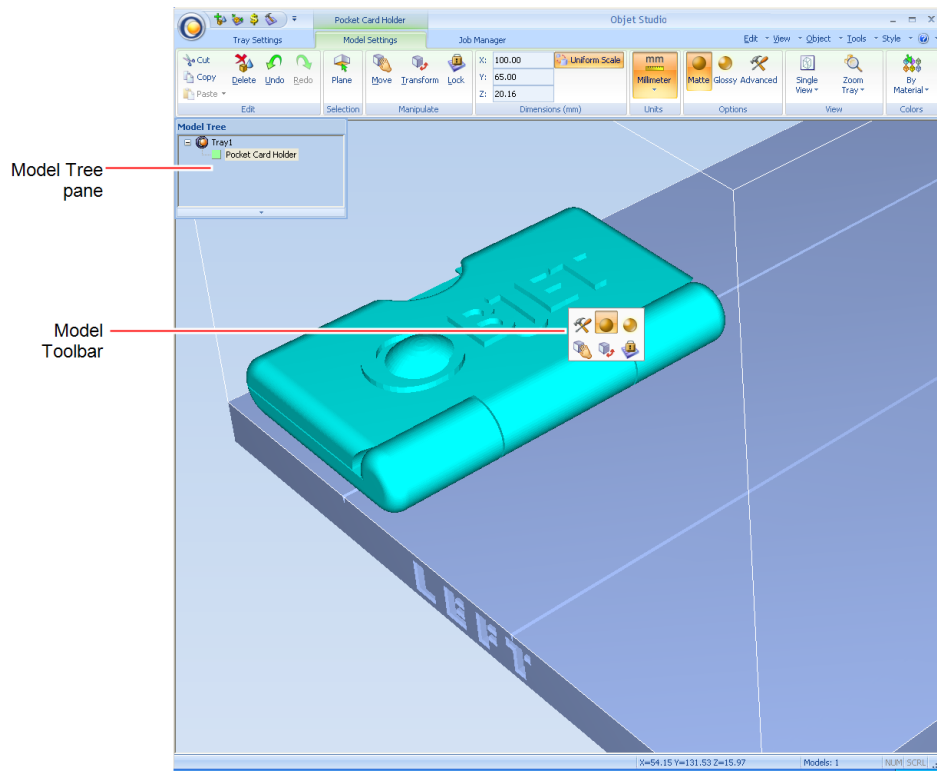

Figure 5-11 Default screen layout

The *Model Settings* ribbon is displayed when objects are placed on the build tray.

If the object is over a certain size, the *Loading Placed Elements* dialog box appears.

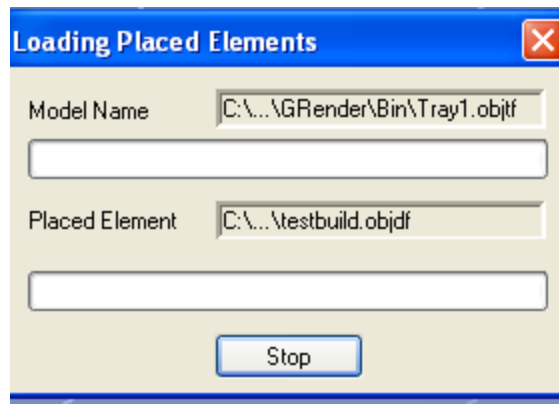

Figure 5-12 *Loading Placed Elements* dialog box



You can speed up the opening of large files by changing the *Large Files* settings—see "Loading Large Files" on page 5-35.

## Opening *objdf* Files

Before placing *objdf* files on the build tray, Objet Studio must extract the component *stl* files together with information about their relative position and model materials. To do this, Objet Studio creates a folder with the same name as the *objdf* file, in the same location.



If you are opening an *objdf* file, the *Insert* dialog box also includes a *Materials* field that shows the object's printing material assignment (see below).

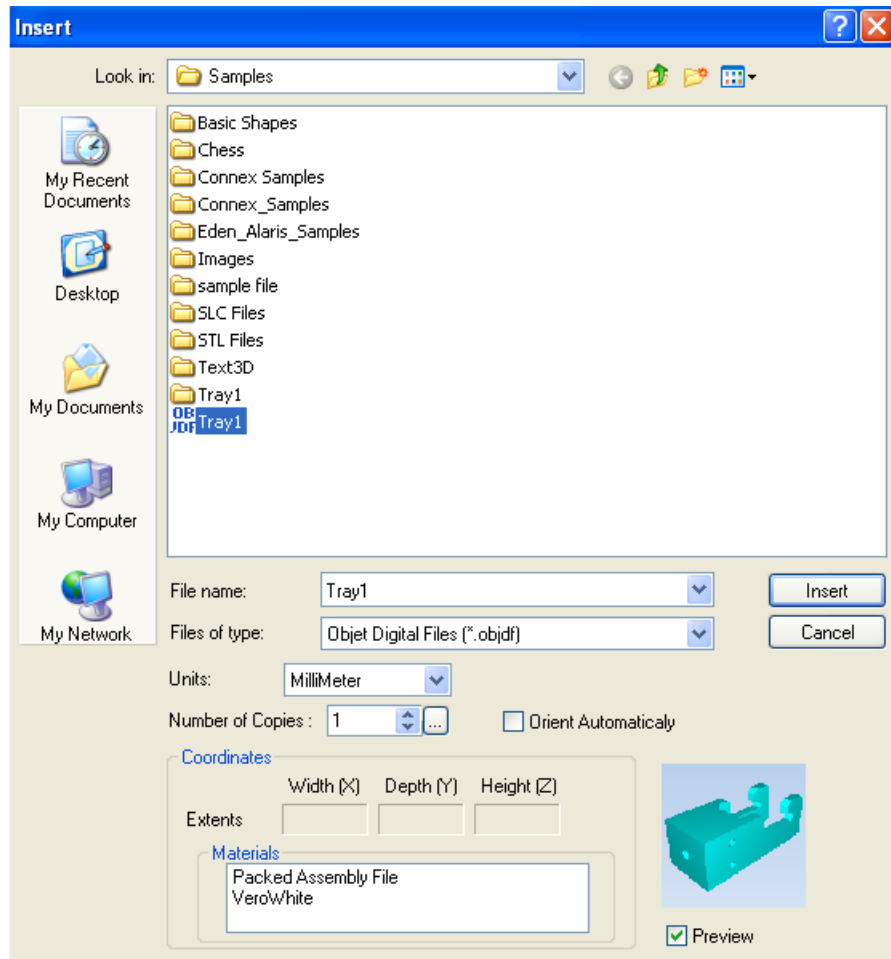



Figure 5-13 *Insert* dialog box (*objdf* file)

## Opening Objet Tray Files

You can open trays that were saved as *objtf* files. (Saving *objtf* is described in "Saving and Importing Build Trays" on page 5-48).

To place an object saved as an Objet Tray File (*objtf*) file on the build tray:

1. From the *File* group, click  *Open*.
- or—

From the Objet Studio Commands menu , select *Open*.  
The *Open* dialog box is displayed.

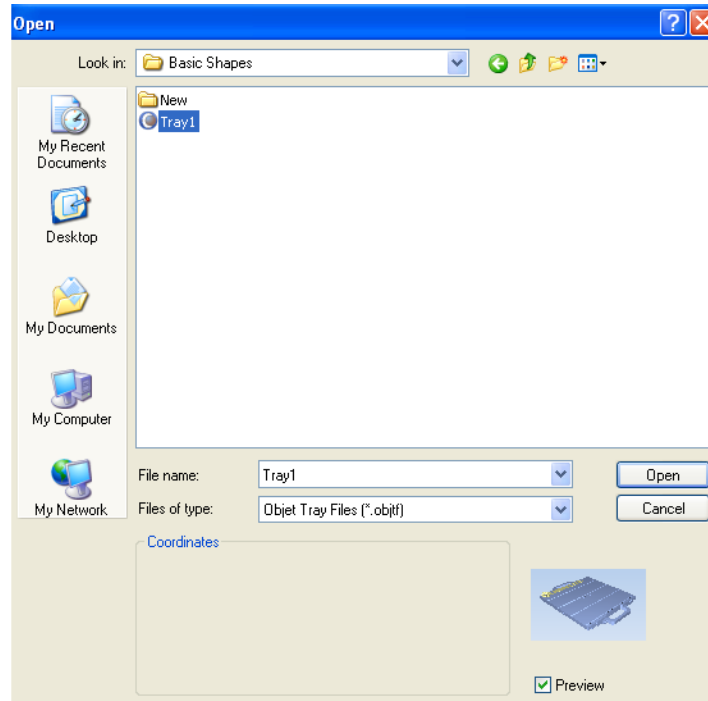

Figure 5-14 Objet Tray File *Open* dialog box

2. Select the desired file, and make sure that it appears in the *File name* field. If the *Preview* check box is selected, the object is displayed.
3. Click *Open*.  
Objet Studio opens the tray file.



The *objtf* file is actually a file containing instructions for printing—which *stl* files to print and their position on the build tray. Because the *objtf* file references the *stl* files used, they must remain in the same file location as when the *objtf* file was saved.

**STL file loading preference** If there are identically named *stl* files in more than one location, you need to ensure that the correct component *stl* files are linked to the *objtf* file. For example, if there are identically named *stl* files on one drive and on a flash drive (this can occur if you copy the original files to a working folder), you can set the default location from which files are loaded.

To set the Load Order:

1. From the *Tools* menu, select *Options*.

or—

In the *Objet Studio* Commands menu , click *Options*.

2. In the *Options* dialog box, display the *Settings* tab.

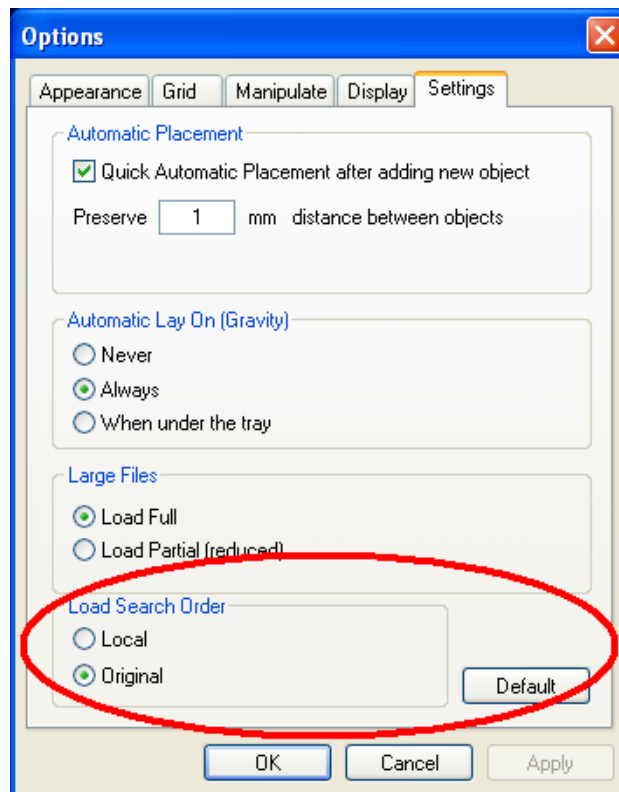

Figure 5-15 *Options* dialog box, *Settings* tab

3. Under *Load Search Order*, select an option:
  - Local*—to load files from the location where they were last saved.
  - Original*—to load files in their original location.
4. Click *OK*.







**Quick-Access Model Commands** You can access common commands for working with objects on the build tray with the convenient Model Toolbar and context menus.

**Model Toolbar** Select an object in the tray to display the Model Toolbar that contains icons to perform common tasks.



Figure 5-16 Model Toolbar

The table below describes the Model Toolbar icons.

Icon	Description
	Applies a matte finish to the model.
	Applies a glossy finish to the model.
	Opens the <i>Advanced Properties</i> dialog box for setting the Grid Style and the Hollow option.
	Enables dragging an object (see page 5-26).
	Opens the <i>Transform</i> dialog box for changing the object's position and scale.
	Toggles the Lock Model Orientation setting.

**Right-click model menu** If you right-click on an object, a pop-up context menu is displayed from which you can also select the model finish, change its position and scale, and set the *Grid Style* and *Hollow* options.



You can also create a Quick Access toolbar with your most commonly used icons grouped together. See "Creating a Quick Access Toolbar" on page 5-49.

## Selecting Objects

To manipulate an object on the build tray or assign characteristics to it (building style, for example), you must first select the object. You select an object by clicking it, either on the tray or in the model tree. Its image on the build tray changes color (to light blue, by default) and its name is highlighted in the model tree. You can select multiple objects by drawing a box around them with the mouse cursor, or by pressing the Ctrl or Shift keys while clicking additional objects.

Alternatively, select or de-select objects using the following *Edit* menu commands:

- Select All
- Invert Selection
- Undo Select object

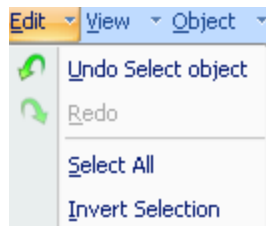

Figure 5-17 *Edit* menu

## Copying and Pasting Objects

If you need to duplicate objects on the build tray, you can insert the same object from its file more than once. An easier way, however, is to copy and paste the object. You can copy objects from the build tray or the model tree. The objects copied remain in the Windows clipboard until you paste them onto the build tray.

You can also copy objects from one tray and paste them onto another, in the same way as you copy text from one document and paste it into another one. However, Objet Studio allows only one tray to be open at a time. For each build tray you need to work with (at the same time), you must open a separate Objet Studio window, by running the application again (from the Windows *Start* menu).



Having multiple Objet Studio windows open can be convenient when you need to manipulate or configure objects before inserting them in your production build tray. Copying and pasting also allows you to use objects already configured on previously-used build trays for newer projects.

You perform the *Copy* and *Paste* commands as in other Windows applications:

- from the right-click context menu.
- by using keyboard shortcuts (Ctrl+C and Ctrl+V, respectively).

The *Paste Special* command (from the object's right-click context menu) enables you to place duplicate objects even more efficiently:

- You can specify the number of duplicates to place on the build tray at once.
- You can set the distance, on each axis, between the duplicate objects.

- You can manipulate mirror images of the original object, and flip them on selected axes.

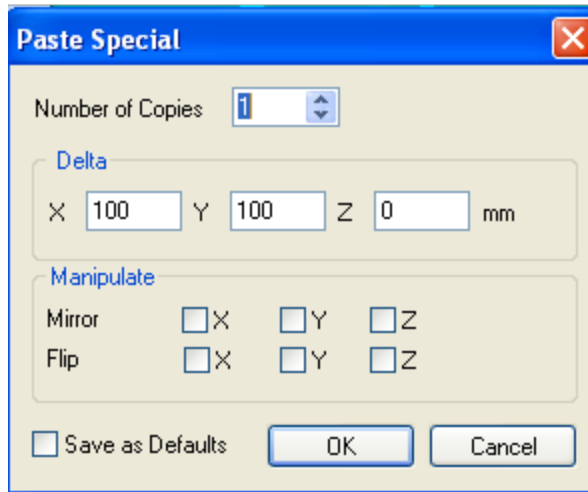



Figure 5-18 *Paste Special* dialog box

## Surface Finish

Models can be printed with a matte or glossy surface finish. To create a matte finish, the printer surrounds models with a thin layer of support material.

To set the model finish:

1. Select the model.
2. Select Matte  or Glossy  in one of the following places:
  - Model Settings* ribbon, *Options* group
  - Model Toolbar
  - right-click context menu (when selecting the model)

You can configure Objet Studio to distinguish between objects' surface finish on the build tray by color. To configure how Objet Studio displays objects, see "Setting Object Colors" on page 5-35.

Before placing objects on the build tray in Objet Studio, you should pay attention to the material selection settings on the *Tray Settings* ribbon.

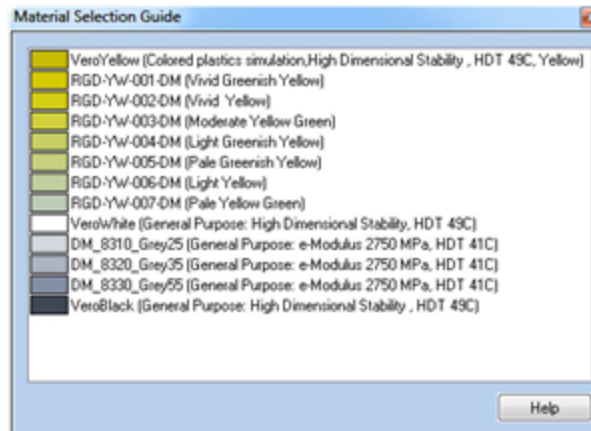

## Positioning Objects on the Build Tray

To produce models efficiently and with the required finish, it is important to carefully position objects on the tray. Objet Studio supports the automatic positioning of objects. However, you should check to make sure that the objects are orientated optimally for your needs, according to the considerations explained in "Manual Positioning" on page 5-20.

Two things that affect the positioning of objects on the tray are *orientation* and *placement*. You can let Objet Studio determine the optimum orientation and position, or you can control them.

### Automatic Orientation

By default, Objet Studio automatically orients objects, when placed on the build tray, for the shortest printing time. (You can later change the orientation manually.) However, you can cancel automatic orientation when placing an object on the build tray.

To place an object on the build tray without automatic orientation:

- In the *Insert* dialog box, make sure *Orient Automatically* is **not** selected.

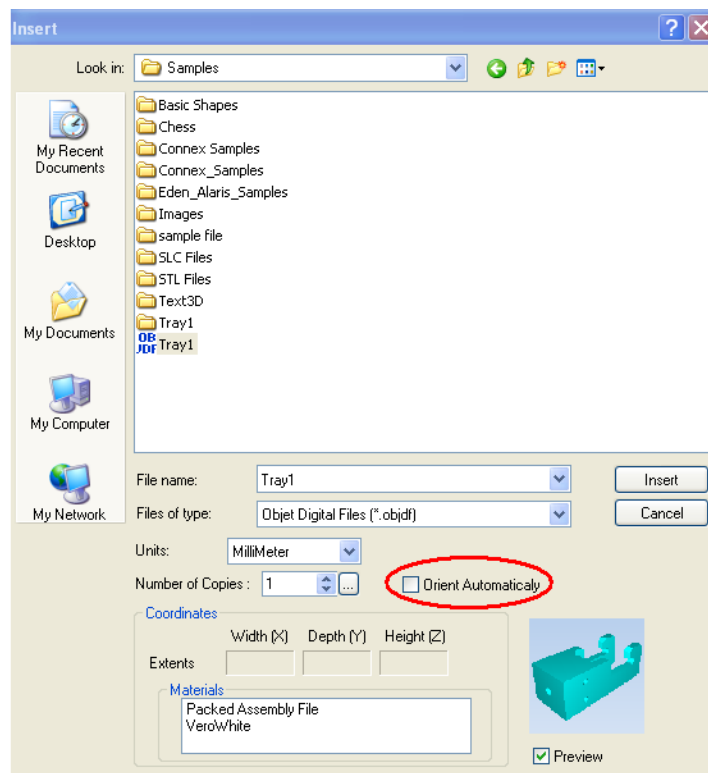

Figure 5-19 *Orient Automatically* option disabled



You can change the default setting, so that automatic orientation is *not* applied unless you select the *Orient Automatically* check box each time you place an object on the build tray. To do this, see "Default Settings" on page 5-57.



## Automatic Positioning

After placing several objects on the build tray, you can let Objet Studio arrange them before printing. This ensures that the objects are positioned properly, and that they will be printed in the shortest time and with a minimum of material.

To automatically arrange objects on the build tray:

- On the *Tray Settings* ribbon, click  Placement.
- or—
- From the *Tools* menu, select Automatic Placement.

The effects of automatic positioning are shown in the figures below.

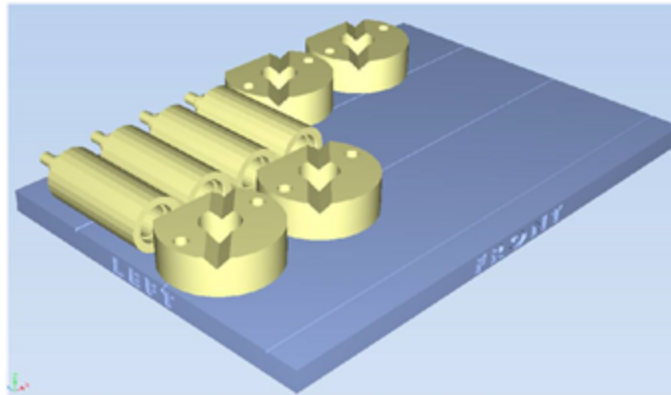

Figure 5-20 Tray before objects are properly arranged

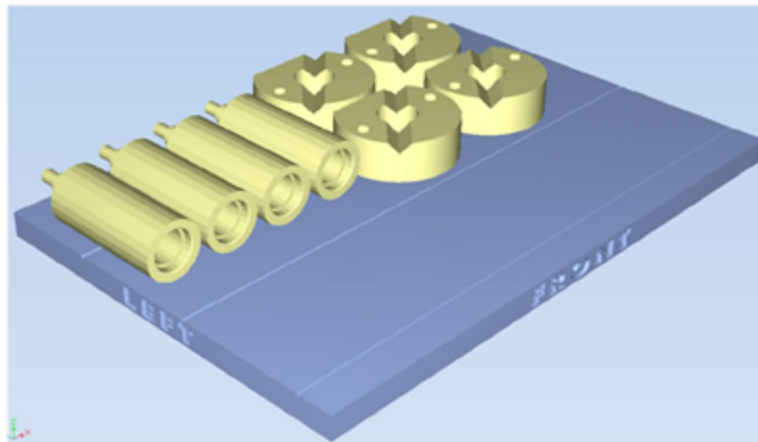

Figure 5-21 Tray arrangement after applying Automatic Placement



- For best results, arrange the tray with *Automatic Placement*, on the *Tray Settings* ribbon, even if you inserted the objects with the *Orient Automatically* option.
- The physical characteristics of each type of Model material you use can affect the positioning of objects on the tray. Therefore, select materials **before** running *Automatic Placement*.

## Manual Positioning

You can change the position of objects on the build tray—even if they were inserted with the *Orient Automatically* option. Tools for changing the position of objects are presented in "Manipulating Objects on the Tray" on page 5-22.

The orientation of models on the build tray affects how quickly and efficiently they will be produced by the printer, where and how much Support material is used, and whether or not model parts will have a glossy finish. Therefore, you should consider a variety of factors when deciding how to place models on the build tray, using the following positioning rules.

### X-Y-Z Rule

This rule considers a model's outer dimensions.

- Since the print heads move back and forth along the X-axis, the printing time along this axis is relatively short, compared to printing time along the Y-axis and Z-axis. From this point of view, it is advisable to place the object's *largest* dimension along the X-axis.
- Any surfaces that come into contact with Support materials become matte.
- Since models are built up, on the Z-axis, in 15–36-micron layers (according to the printing mode), it is very time-consuming to print a tall object. From this point of view, it is advisable to place the object's *smallest* dimension along the Z-axis.
- Since the print heads measure about 2 inches (5 centimeters) on the Y-axis, models measuring less than this (on the Y-axis) are printed in one pass. From this point of view, it is advisable to place the object's *intermediate* dimension along the Y-axis.

### Tall-Left Rule

This rule considers models where, after being orientated on the build tray according to other considerations, one side is taller than the other.

- Since the print heads move along the X-axis from left to right, taller sections on the right require the print heads to scan unnecessarily from the left until reaching them. If, on the other hand, the taller sections are positioned on the left of the build tray, the print heads only have to scan the model until printing these sections—once the lower parts have been completed. Therefore, you should position the taller side of the model, when possible, *on the left*.



The following rules are based on the fact that Support material is not required on the top of the printed model.

### Recess-Up Rule

This rule considers models containing surface recesses.

- Recesses in the surface (like hollows, drill holes, etc.) should, when possible, be positioned *face-up*.

### Fine-Surface Rule

This rule considers models that have one side on which there are fine details (like the keypad side of a telephone).

- The side of the model containing fine details should, when possible, be positioned *face-up*. This results in a smooth finish.

### Avoid Support-Material Rule

This rule considers models that have large holes or hollows, open on at least one side (like a pipe or a container).

- It may be advantageous to print a model *standing up*, so Support material does not fill the hollow, even though printing the model lying down would be much faster.

## Manipulating Objects on the Tray

### Positioning Objects on the Z-Axis

When you use the automatic positioning option to arrange objects on the build tray (see "Automatic Orientation" on page 5-18), the objects are positioned directly on the tray. If you do not insert objects with automatic positioning, they often appear either above or below the tray.



In practice, the Objet system prints all models on the build tray on a one-millimeter bed of support material. The importance of positioning objects directly on the build tray with Objet Studio is to correctly display the objects on the screen.

To position objects directly on the tray:

1. Select the object.
2. From the *Object* menu, select Lay On.

To ensure that objects are always positioned directly on the tray:

1. From the *Tools* menu, select Options, and display the *Settings* tab.

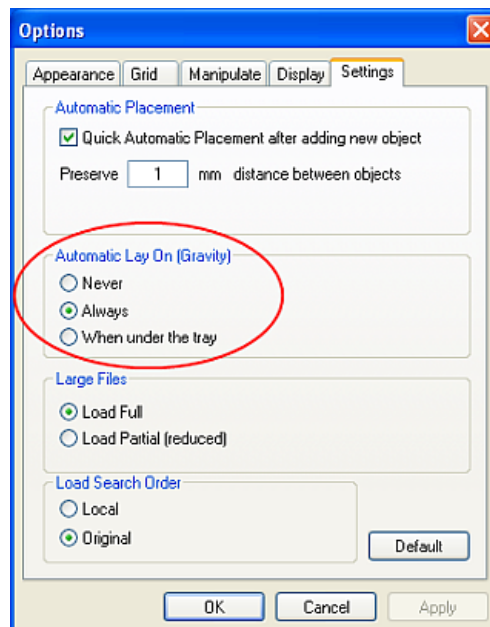

Figure 5-22 Options dialog box, Settings tab

2. In the *Automatic Lay On (Gravity)* section, select Always.

Other Z-axis options (in the *Automatic Lay On* section):

- **When under the tray**—The display of objects that are below the build tray is automatically changed so that the object is at tray level.
- **Never**—The display of objects that are above or below the build tray is not changed.

## Valid Object Placement

You can ensure that models do not overlap when you position them on the build tray, and that they do not extend beyond the tray.

To ensure valid object placement:

1. From the *Tools* menu, select Constraints Settings.

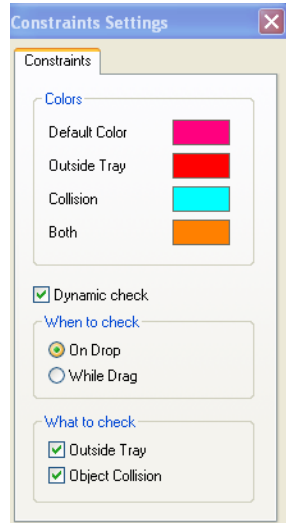

Figure 5-23 *Constraints Settings* dialog box

2. Select Dynamic check to identify—
  - invalid object placement while placing objects—*On Drop* selected.
  - invalid object placement after moving objects—*While Drag* selected.
  - objects placed beyond the tray’s boundaries—*Outside Tray* selected.
  - objects that overlap—*Object Collision* selected.



Even if you do not use *Dynamic Check* when placing objects on the build tray, Objet Studio automatically checks if there is a problem with the positioning of objects on the tray before sending it to the printer. You can also manually check for problems after positioning objects (see "Tray Validation" on page 5-39).

**Note:** Remember that Objet Studio calculates the space occupied by an object including the “bounding box” surrounding it (see Figure 5-36 on page 5-31).

Using a Grid to Position Objects

Displaying a grid on the image of the build tray can be useful when positioning objects. To use the grid features, select the following menu options.

Menu Option	Result
Tools > Grid	Displays a grid on the build tray.
Tools > Snap to grid	When moving the object, it aligns with the nearest grid line.
Tools > Options > Grid	Enables you to change the grid origin (X- and Y-axis meeting point) and appearance.

You can review and configure grid settings—and apply them—from the *Options* dialog box.

To view and change grid settings:

1. From the *Tools* menu, select *Options*, and display the *Grid* tab. The current grid settings are displayed.

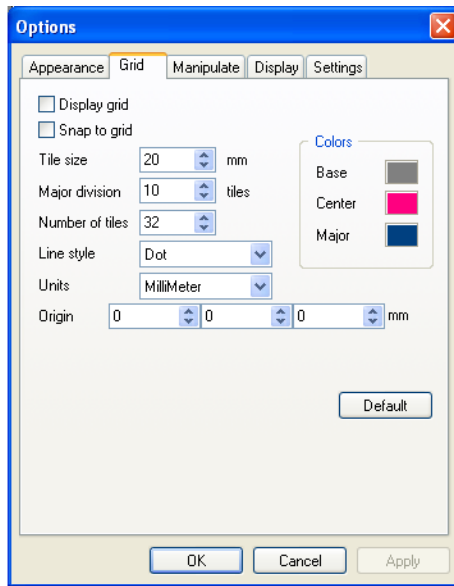

Figure 5-24 *Options* dialog box, *Grid* tab

2. As required, change the settings, and select or clear the check boxes.
3. Click *Apply* or *OK*.

## Measurement Units

3D files contain an object's proportions, but not its units of measure. Therefore, make sure to correctly select either millimeters or inches when inserting an object. Otherwise, the size of the object on the build tray will be either much too large or much too small.

To set the measurement units when inserting an object:

- In the *Insert* dialog box, *Units* field, select Millimeter or Inch:

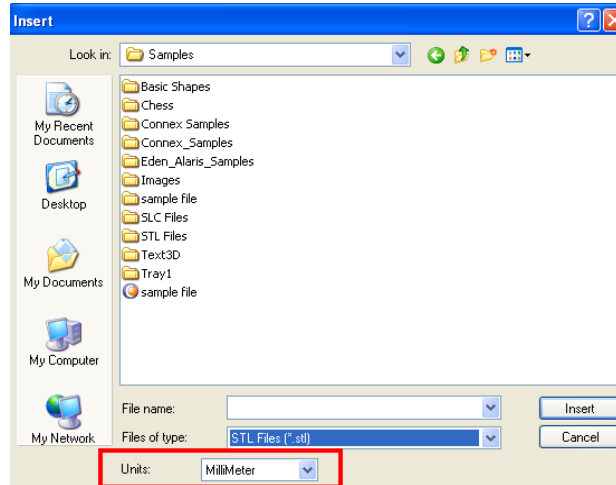

Figure 5-25 *Units* field in the *Insert* dialog box

To change measurement units for a selected object from the *Model Settings* ribbon:

1. Open the *Units* flyout toolbar.



Figure 5-26 *Units* flyout toolbar

2. Select the measurement units desired.

To change measurement units for a selected object from the standard toolbar:

1. From the *Object* menu, select Change Units.

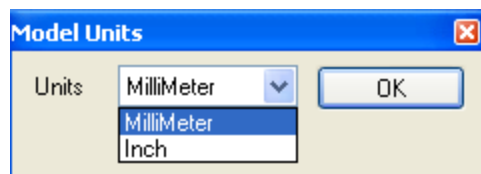

Figure 5-27 *Model Units* dialog box

2. In the *Model Units* dialog box, change the setting and click OK.

## Setting Model Dimensions

You can change an object's dimensions by changing its size on the X-, Y-, and Z-axes, from the *Dimensions* group on the *Model Settings* ribbon.



Figure 5-28 *Dimensions* on the *Model Settings* ribbon

- If *Uniform Scale* is enabled, changing the object's dimension on one axis affects the other dimensions, proportionately.
- After changing a measurement, press Enter or click in another field in the *Dimensions* group.

**Note:** You can change the height of the objects on the build tray only if this is allowed by the Objet Studio settings (see "Positioning Objects on the Z-Axis" on page 5-22).

## Repositioning Objects

You can manually move and rotate an object on the build tray with the arrow keys, or by dragging it with the mouse.

To manually manipulate an object:

1. Select an object by clicking it on the build tray, or in the model tree pane.



2. Click **Move** on the Model Toolbar, or on the *Model Settings* ribbon.

A frame appears around the object, and the cursor changes to indicate that the object can be moved.

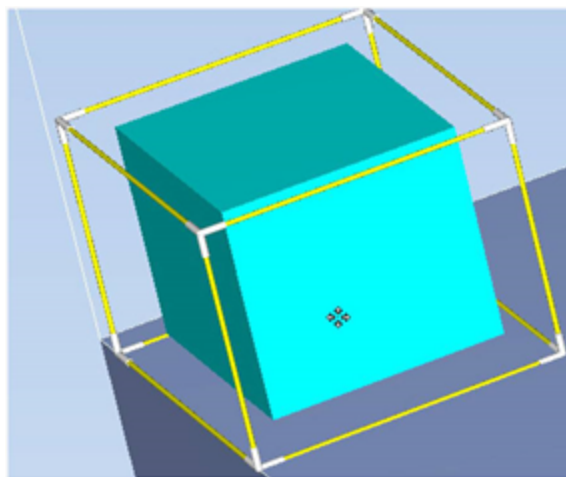

Figure 5-29 Manually moving an object



3. If you click on a corner of the frame, the cursor changes to indicate that the object can be rotated.

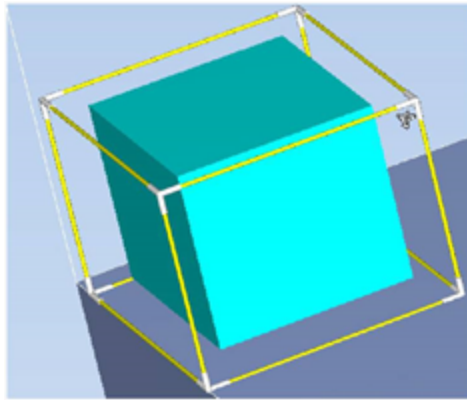



Figure 5-30 Manually rotating an object

4. Manipulate the object with the arrow keys or with the mouse.

### Using the Transform Dialog Box

You can make precise changes to an object by changing the properties in the *Transform* dialog box.

To access the *Transform* dialog box (when an object is selected):

- Click  on the Model Toolbar or on the *Model Settings* ribbon.
- From the right-click context menu, select Transform.
- From the *Object* menu, select Transform.

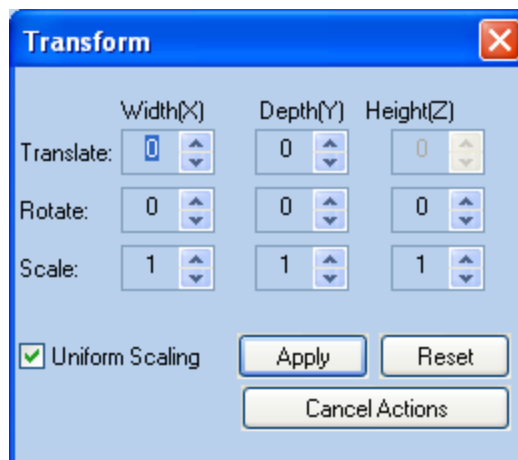

Figure 5-31 *Transform* dialog box

To change an object with the *Transform* dialog box:

- Change any of the values, then click *Apply* to see how the object changes on the build tray.

**Note:** The changed values remain in the dialog box after clicking *Apply*. Therefore, you can make small changes to values in the dialog box to see how the object changes on screen each time you click *Apply*.

To reset all of the values in the dialog box:

- Click Reset.

**Note:** The object does not change. Any changes previously applied remain.

To undo **all** changes made with the *Transform* dialog box:

- Click Cancel Actions.



After closing the *Transform* dialog box, clicking *Undo* (on the *Model Settings* ribbon or from the *Edit* menu) cancels **all** changes made with the dialog box.

## Changing an Object's Orientation

There are several methods for changing the orientation of objects on the build tray.

To rotate an object:

- Select the object and use the *Object* menu options (see also "Repositioning Objects" on page 5-26).

To re-align an object's plane:

1. On the *Tray Settings* or *Model Settings* ribbon, click  .

**or—**

From the *Tools* menu, select *Plane Alignment* > *Select Plane*.

2. Click on part of an object on the build tray.

The selected plane is displayed.

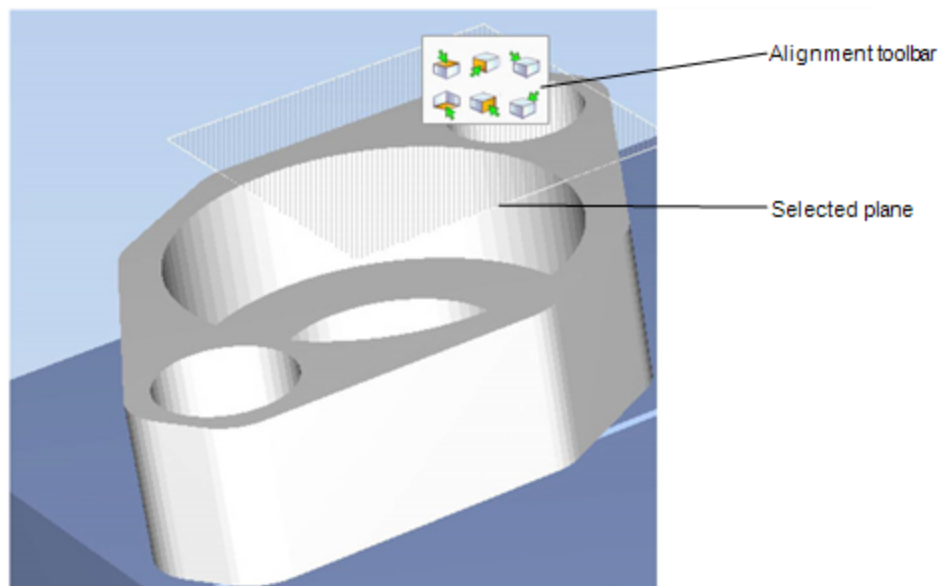

Figure 5-32 Aligning by plane

3. On the Alignment toolbar, click an appropriate icon to change the alignment.

or—

From the *Tools* menu, select Plane Alignment, and select an alignment option.

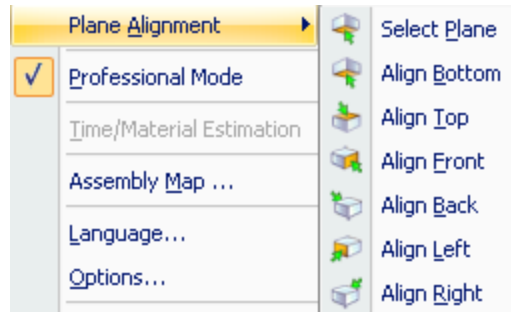



Figure 5-33 *Tools* menu, *Plane Alignment* options

To cancel plane selection after re-aligning objects on the build tray:

- On the *Tray Settings* or *Model Settings* ribbon, click  .
- or—**
- From the *Tools* menu, select Plane Alignment > Select Plane.

To flip an object 180 degrees on any axis:

1. Select the object.
2. From the *Object* menu, select Flip > Flip X / Flip Y / Flip Z.

To make precise changes to the object's orientation on any axis:

1. Select the object.
2. Display the *Transform* dialog box (see Figure 5-31 on page 5-27).
3. Change the Rotate parameters for each axis.

## Freezing Model Orientation

If you manipulate an object on the build tray, you can freeze its orientation so that it does not change when you position it automatically (see "Automatic Positioning" on page 5-19).

To freeze an object:

1. Select an object on the build tray.
2. On the *Model Settings* ribbon, in the *Manipulate* group, or on the Model Toolbar, click .

To unfreeze an object:

- Select the object and click  (to de-select it).

## Display Options

### Viewing Objects

From the *View* menu, you can change the way objects are displayed. The default method for displaying models on the build tray is as solid (“shaded”) objects.

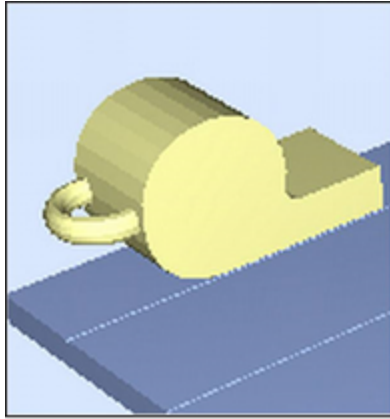

Figure 5-34 Tray and model displayed in *Shaded* view

The other display options are *WireFrame* and *Points*.

To display the build tray in *WireFrame* view:

- From the *View* menu, select *WireFrame*.

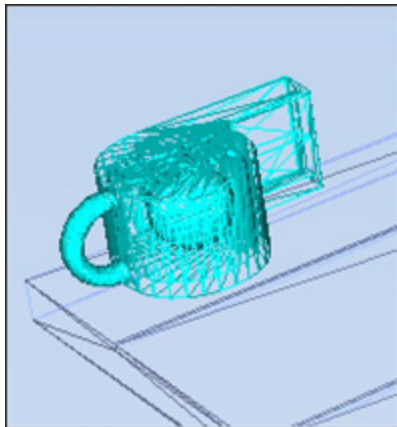

Figure 5-35 Tray and model displayed in *WireFrame* view

To revert to the *shaded* view:

- From the *View* menu, select *Shaded*.

To display objects as boxes, showing their maximum dimensions instead of their shape:

- From the *View* menu, select Display Bounding Box.

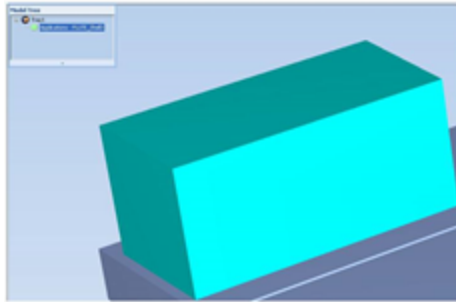

Figure 5-36 Model displayed with bounding box

To display the area around objects needed for support material (to produce a matte finish):

- From the *View* menu, select Display Thickening Box.

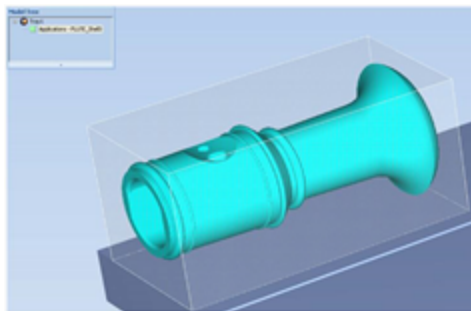

Figure 5-37 Model displayed with thickening box

To display the maximum build height:

- From the *View* menu, select Display Tray 3D Box.

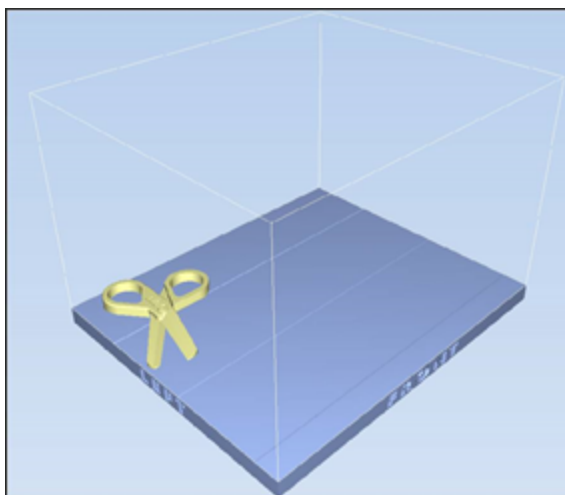

Figure 5-38 Tray 3D Box

To display objects without the build tray:

- From the *View* menu, clear (de-select) the *Display Tray* option.

## Screen Layout

Objet Studio automatically adjusts the default screen layout to display the optimum views of the build tray and the model tree. You can view models from different perspectives by changing the screen layout.

To change the screen layout:

- On the *View* flyout toolbar, select *Single View*, or *4 Views*.

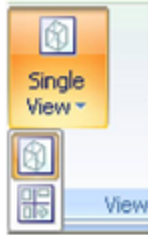



Figure 5-39 Screen layout icons

- Single View  is the default screen layout.
- 4 Views  displays *perspective*, *top*, *front* and *right* views.

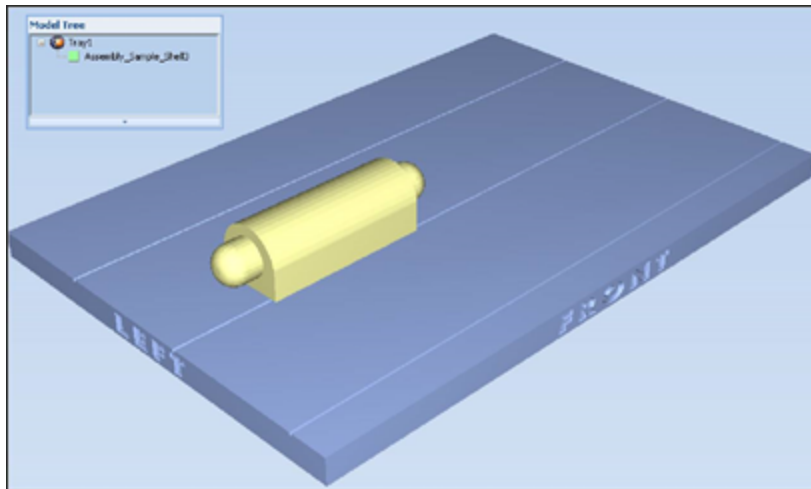

Figure 5-40 Single-view screen layout

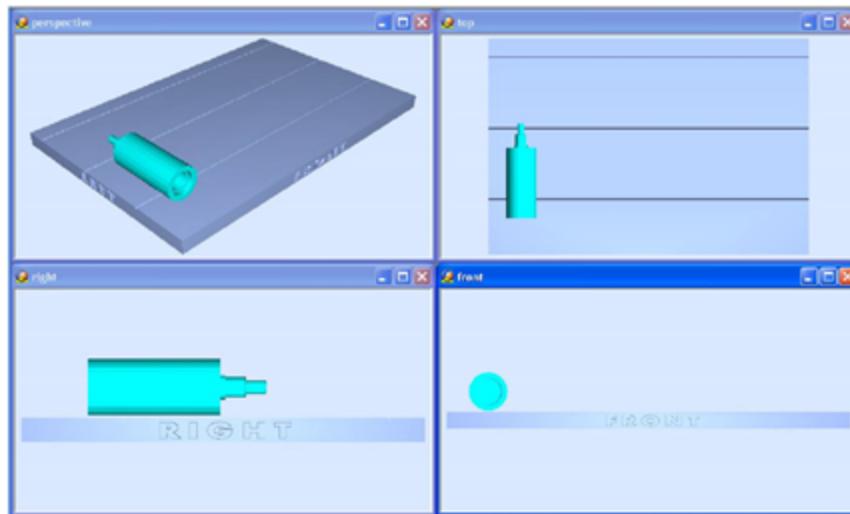

Figure 5-41 4-view screen layout

## Tray Perspective

The default perspective of the build tray is “isometric.” You can change the perspective of the active window with one of ten options.

To change the perspective of the build tray in the active window:

1. On the *Tray Settings* ribbon, open the *Perspective* flyout toolbar.



Figure 5-42 *Perspective* toolbar

2. Click the icon that represents the desired perspective.

**Tray Positioning** To view the tray and models from different directions, you can move the tray around the screen and change its display angle.

To move the tray in the Objet Studio screen:

- Press the mouse wheel while moving the mouse.

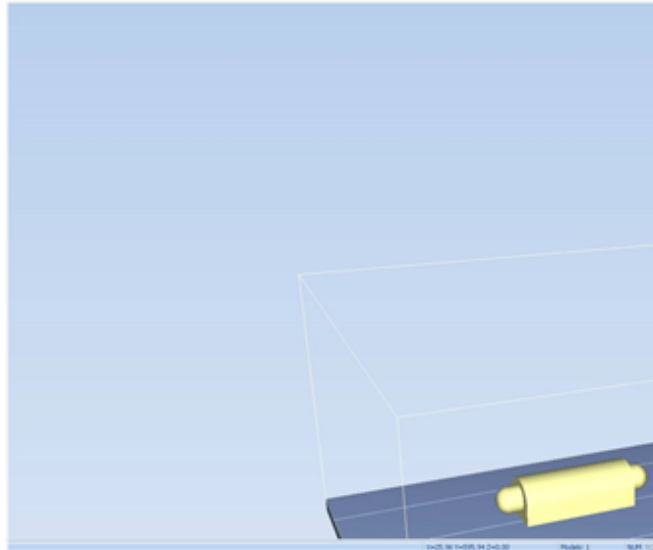

Figure 5-43 Tray after moving it in the Objet Studio display

To manually rotate the tray:

- Press Alt and press the mouse wheel while moving the mouse.

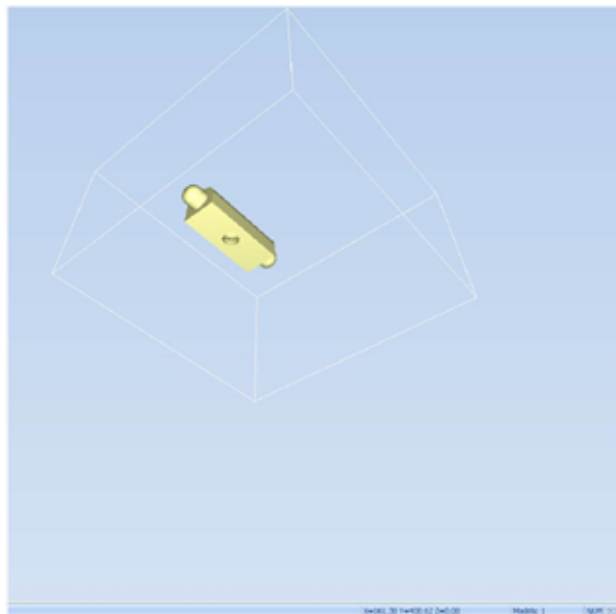

Figure 5-44 Tray after rotating it upside-down

To view the tray and models from different directions, you can change its display angle.



## Setting Object Colors

The color of objects on the build tray can indicate how they are printed. Objet Studio enables you to choose the color display so that you can easily see the material, and surface of objects.

To choose how colors are applied on the display:

- On the *Model Settings* ribbon, in the *Colors* group, select one of the options from the flyout toolbar.



Figure 5-45 Colors display options



Before sending a build tray to the printer, or when you perform *tray validation*, Objet Studio checks if there is a problem with the *stl* files or the positioning of objects on the tray. If so, the affected objects are displayed with special colors (see "Tray Validation" on page 5-39).

## Loading Large Files

Very large *stl* files can be slow to load and may be difficult to manipulate easily on the build tray. If this is the case, you can display just an image of the object on the build tray without loading the entire file. The *stl* file itself is not changed, and the complete file is sent to the printer.

To display an image of *stl* files when you place objects on the build tray:

1. From the *Tools* menu, select *Options*, and display the *Settings* tab.

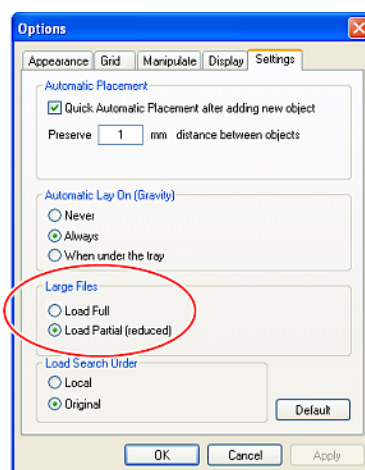

Figure 5-46 Options dialog box, Settings tab

2. In the *Large Files* section, select *Load Partial (reduced)*.

## Large File Manipulation

If you need to work with a detailed model that is composed of a large number of polygons, you can speed up its display and manipulation in Objet Studio by reducing the number of polygons on the screen. Although this may reduce the resolution on the screen, it has no affect on the printed models.

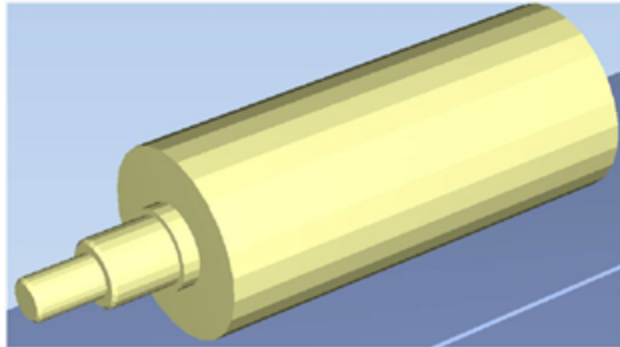

Figure 5-47 Object displayed without polygon reduction

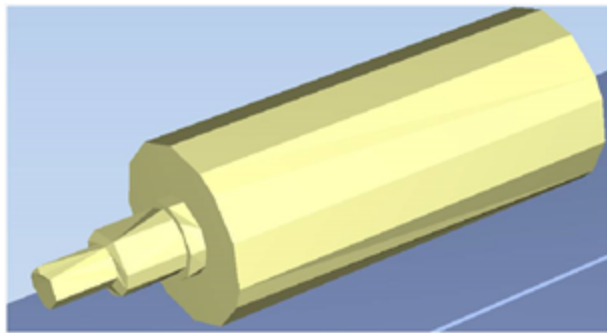



Figure 5-48 Object displayed with only five percent of its polygons showing

To use polygon reduction:

1. From the *Tools* menu, select Options.  
or—

From the Objet Studio Commands menu , click Options.

- In the *Options* dialog box, display the *Display* tab.

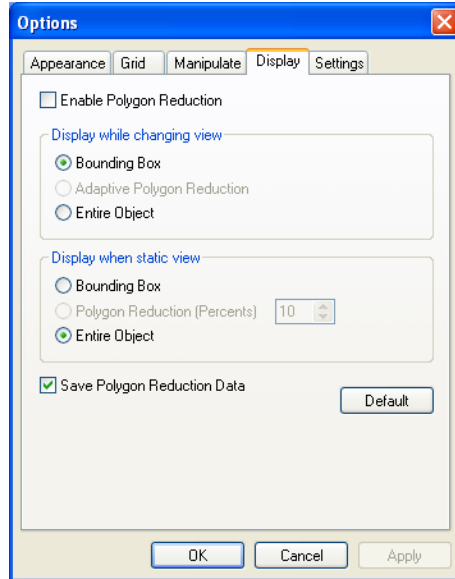

Figure 5-49 *Options* dialog box, *Display* tab

- Select **Enable Polygon Reduction**.
  - Select **Polygon Reduction (Percent)**.
  - Enter the percentage of total polygons to display.  
When you click **Apply**, the display changes.
- Note:** The setting affects the static display (when the object is not being moved).
- Set display options when the object is being moved (*Display while changing view*):
    - Bounding Box*—A box representing the object’s maximum dimensions is displayed.
    - Adaptive Polygon Reduction*—Varying degrees of polygon reduction are applied, as necessary.
    - Entire Object*—No polygon reduction is applied.
  - To save these settings, so that they will be applied every time you place **this object** on the build tray, click **Save Polygon Reduction Data**.
  - Click **Apply** to see the results of the settings without closing the dialog box.



Selecting the *Entire Object* option cancels polygon reduction.

**Object display options** The display format affects how quickly objects display. For example, if you select **Bounding Box**, objects display faster than they do when you select **Entire Object**. You can choose display formats for objects when they are stationary (*static view*) and for when you are dragging them (*changing view*).

To select the object display preference while changing view, and in static view:

1. Select to display objects:
  - With a *Bounding Box* (see Figure 5-36 on page 5-31)
  - With *Adaptive Polygon Reduction* (*changing view* only)
  - With *Polygon Reduction* (*static view* only)
  - Entire Object*
2. Click OK when done.

**Zoom Options** While manipulating objects, you often need to view them at different zoom levels.

To change the zoom level:

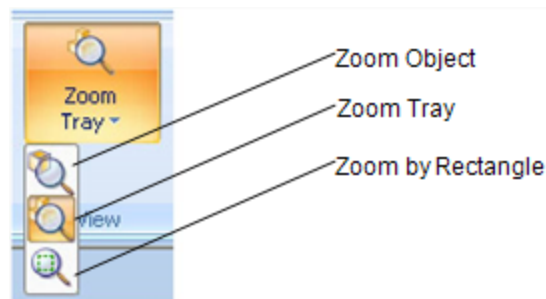

Figure 5-50 Zoom flyout toolbar

- Zoom Object* focuses on the selected object.
- Zoom Tray* displays the whole tray.
- Zoom by Rectangle* allows you to display a section of the tray by selecting it with the mouse.

You can also zoom in and zoom out with the mouse wheel.

You can configure Objet Studio to automatically zoom in on the objects placed on the build tray. See "Automatic Zoom" on page 5-58.

## Handling Trays

After preparing models on the build tray, you can do the following:

- Test that it can be printed ("validation").
- Calculate the time and material resources needed to print it.
- Send it to the printer for production.
- Save it for later completion or printing.
- Save it as a compressed file for convenient storage and transfer.

**Tray Validation** Before sending a job to the printer for production, you should check that the tray is “valid” and can be printed.

**Note:** Because of the unique characteristics of each type of modeling material, make sure that the correct material is selected *before* performing Tray Validation.

To validate that the tray can be printed:

- On the *Tray Settings* ribbon, in the *Build Process* group, click  Validate.
- or—

From the *Tools* menu, select Placement Validation.

If the tray is not valid, the color of the problematic models on the tray changes according to a pre-set code.

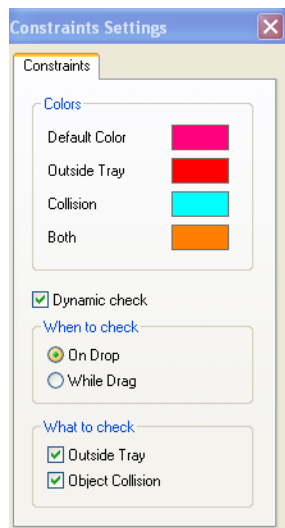

Figure 5-51 Color code

**Note:** The “Both” color also indicates a problematic *stl* file.

The validation status appears on the bar at the bottom of the screen.

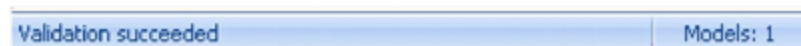

Figure 5-52 Validation details in status bar

**Printing Modes** When preparing models for printing on **Objet30 Prime** and **Objet30 Dental Prime** printers, you can choose one of the following quality/speed settings.

Mode	High Quality	High Speed	Draft
Prime	✓	✓	✓
Dental Prime	✓	✓	✓

HQ (High Quality) Mode—

- Prints models in 15-micron layers, suitable for producing fine details and delicate items.
- Requires much more time to print most trays, compared to HS mode.

**Note:** HQ mode is not available when Tango materials are chosen.

HS (High Speed) Mode—

- Prints models in 28-micron layers, suitable for producing most models.
- Requires much less time to print most trays, compared to HQ mode.

Draft Mode—

- Prints models in 36-micron layers, suitable for producing initial designs.
- Fastest printing mode.
- Most economical printing mode.

**Note:** Draft mode is not available when Tango materials are chosen.

The quality of models printed in Draft mode depends on many factors and it may be inconsistent over time. Even printing the same file may produce different results at different times. If the quality is not acceptable, use HS or HQ mode.

You select the printing mode in the *Tray Materials* area of the *Tray Settings* ribbon. Change the setting, if necessary, before sending the tray to the 3D printer.

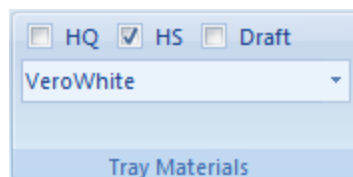

Figure 5-53 Printing-mode selection

## Production Estimates

Objet Studio enables you to calculate the time and material resources needed for producing trays before sending them to the printer. The time it takes Objet Studio to perform this calculation depends on the number of objects on the tray and their complexity. Calculating the production estimate for a full tray could take up to 15 minutes, depending on your computer's specifications.

To calculate the time and materials needed for producing the current tray:

- On the *Tray Settings* ribbon, in the *Build Process* group, click . While the estimate is being calculated, a progress bar is displayed—on the right side of the status bar (at the bottom of the screen).



Figure 5-54 *Estimate* progress bar

When Objet Studio finishes calculating the production resources, the results are displayed in the *Estimated Consumptions* group on the *Tray Settings* ribbon.

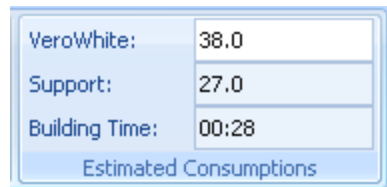

Figure 5-55 Production resource calculation

## E-mailing Objet Digital Files

You can easily e-mail *objdf* files using Microsoft® Office Outlook®. Sending *objdf* files is recommended (instead of *stl* files) because the size of a file is typically reduced by more than half. An added benefit is that the *objdf* file contains the model-material information for the object.

To e-mail a file:

1. From the *Tools* menu, select *Email Objet Digital File*. Outlook opens with the file attached and *Subject* details added to the e-mail form.
2. Enter the e-mail address and send the file.

## Printing the Tray

When a tray is ready to be printed, it is placed in the *Jobs Queue*. When the job reaches the head of the queue, Objet Studio pre-processes the tray file to create slices, and feeds them to the printer.

To send the tray to the print queue:

- On the *Tray Settings* ribbon, *Build Process* group, click .

If the build tray file has not been saved, the *Save As* dialog box opens for you to save it now.

Objet Studio checks if there is a problem with the positioning of objects on the tray. If so, the affected objects are displayed with special colors (see "Tray Validation" on page 5-39), and a warning message appears.

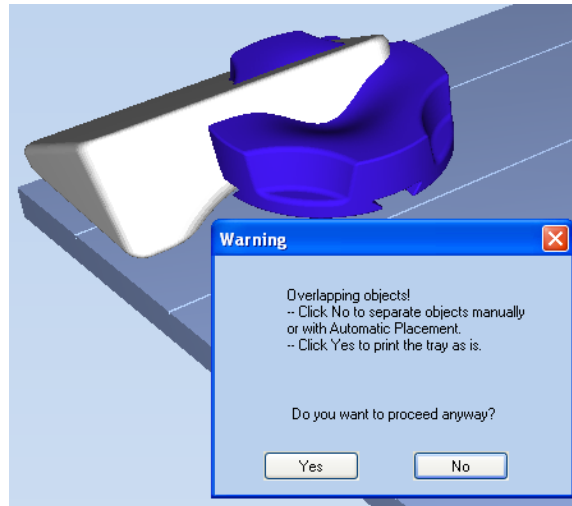

Figure 5-56 Tray validation warning message

- To cancel the *Build* command so you can correct the problem, click **No**.
- To print the models as they are positioned on the tray, click **Yes**.

The *Job Manager* screen opens, so you can monitor the progress of your trays—before, during, and after printing. See "Monitoring and Managing Print Jobs" on page 5-63.



## Applying Additional Objet Studio Features

The following topics describe additional features available in Objet Studio:

- Dividing Objects
- Displaying the Cross Section of Objects
- Saving the Screen Display as an Image File
- Saving and Importing Build Trays

### Dividing Objects

You can use the Split Object feature to produce objects larger than the tray area by dividing the model into separate parts. With this feature, you produce only a specific section of a model.

To split an object:

1. Select the object.
2. From the *Object* menu, select *Split*.
3. In the *Split Object* dialog box, enter the values to determine how Objet Studio will divide the object. You can divide an object along any of its axes, by entering either exact measurements or the number of parts.

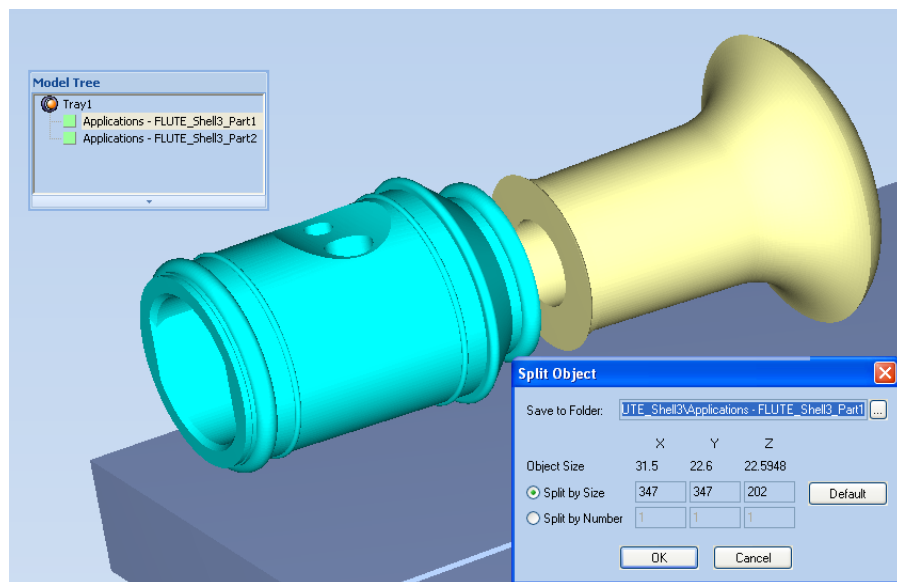

Figure 5-57 *Split Object* dialog box

4. In *Save to Folder*, enter the folder name.
5. Click OK.



The composite parts are saved as new *stl* files with “Part 1,” “Part 2,” etc., added to the original file name.

**Note:** Before printing the newly created *stl* files, it is recommended that you check them for defects in an STL-repair application, such as Magics™, by Materialise®.

## Choosing the Support Strength

When producing models, support material fills some hollow and empty sections (see "Manual Positioning" on page 5-20). Objet Studio allows you to adjust the strength of the structure formed with the support material. This adjustment is useful when producing either large/massive models or small/delicate models. For most purposes, the default setting provides adequate support strength.

To change the strength of the support structure used when printing a model:

1. Select a model on the tray.
2. On the *Model Settings* ribbon, in the *Options* group, click .
  - or—
  - On the Model Toolbar, click .
  - or—
  - From the right-click context menu, select *Advanced Properties*. The *Advanced Properties* dialog box opens.

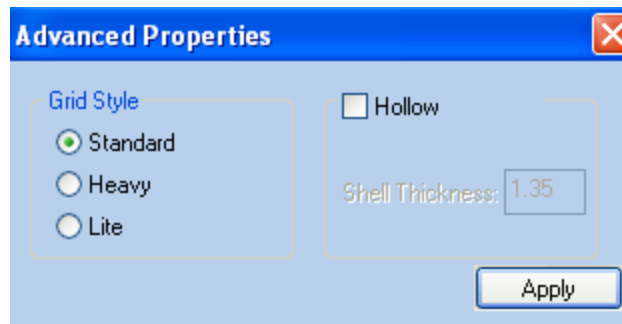

Figure 5-58 *Advanced Properties* dialog box

**Note:** If an object is split into shells, the *Advanced Properties* enabled vary with the object selection. If a single element is selected only *Hollow* is enabled. If a group of elements is selected only *Grid Style* is enabled.

3. In the *Grid Style* section, choose the support strength suitable for the selected model. You can select a different support strength for each model on the tray.
  - Standard**—for models needing average support (most models).
  - Heavy**—for large models needing much support.
  - Lite**—for models printed using SUP706 Support material and for delicate models needing little support. (This setting makes it easy to remove the support material.)
4. Click **Apply**.

## “Hollow”— Filling Models with Support Material

Many objects placed on the tray from *stl* files are “solid.” This means that, when printed, the model will be completely filled with model material. Often, especially with large objects, this is unnecessary. Instead, the model can be filled with support material, which is less costly. It is also advisable to fill models with support material when preparing them for investment casting, since this material burns off more quickly during the process of making the cast.

Objet Studio enables you to print objects on the tray with an outer shell of model material and a center filled with support material. When using this feature, called “Hollow,” the thickness of the shell should be no less than 0.5 millimeters.

To use the Hollow feature:

1. Select a model on the tray.  
or—  
 On the *Model Toolbar*, click .  
or—  
 From the right-click context menu, select *Advanced Properties*.  
The *Advanced Properties* dialog box opens.
2. Select *Hollow*.

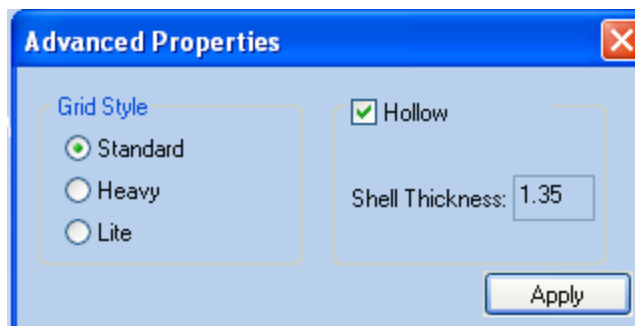

Figure 5-59 *Advanced Properties* dialog box

3. Set the shell thickness, in millimeters.
4. Click *Apply*.

**Note:** There is no change in the display of objects in Objet Studio when *Hollow* is selected.

To inspect, change or cancel the *Hollow* setting:

1. Select a model on the tray.
2. Access the *Advanced Properties* dialog box, as above.
3. If you change or cancel the *Hollow* setting, click *Apply*.

## Displaying the Cross Section of Objects

The *Section* feature enables you to view the interior of an object by “slicing” it on any axis. You can then manipulate the object to inspect the interior from different angles. This may be important for deciding on the type of support necessary when producing the model (see "Choosing the Support Strength" on page 5-44). Displaying an object’s cross section only affects how the tray is displayed on the screen; it does not change the object itself.

To display a cross section of the tray:

1. From the *Tools* menu, select *Section*.  
The *Section* dialog box opens.

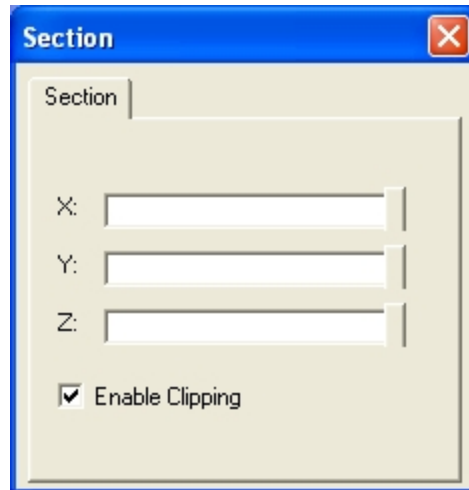

Figure 5-60 *Section* dialog box

2. Select *Enable Clipping*.
3. Use the slider controls for the X-, Y-, and Z-axes to cut the tray so that you see the cross section you want.

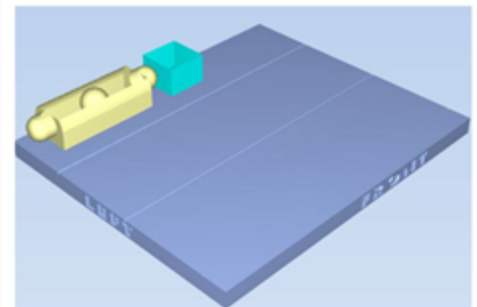
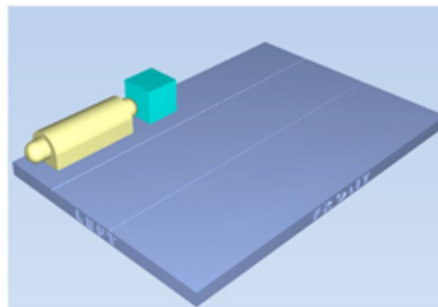

Figure 5-61 **Left:** Whole view; **Right:** Cross section view after using the Z-slider

## Saving the Screen Display as an Image File

You can save the image displayed in the active viewing screen as a graphic file.

To save the screen display as an image:

1. Press Ctrl+B.

or—

From the Objet Studio Commands menu , select Save Bitmap.

The *Save Bitmap* dialog box opens.

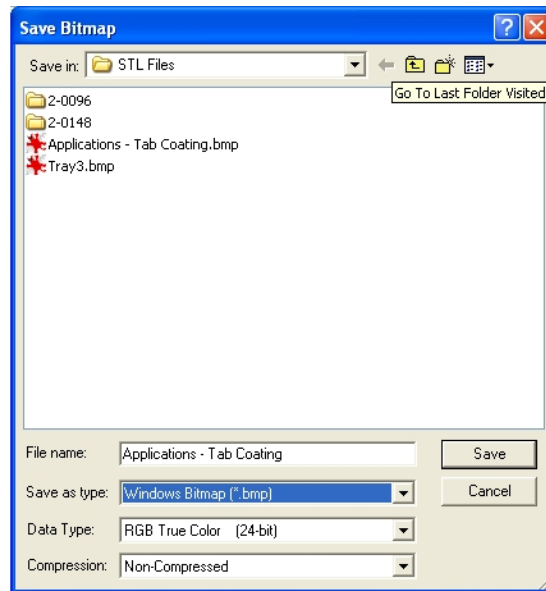

Figure 5-62 *Save Bitmap* dialog box

2. At the top of the dialog box, select the appropriate folder.
3. At the bottom of the dialog box, enter a file name.
4. Open the *Save as type* drop-down list, and select the file format.
5. Click Save.

## Saving and Importing Build Trays

You can save your work in different Objet Studio file formats, depending on how you want to use them later.

### OBJTF Files

*objtf* files contain instructions to Objet Studio and to Objet30 printers for displaying and producing the *stl* files used on the tray. When you save build trays in Objet Studio, they are saved as *objtf* files.

Saving in *objtf* format is useful, for example, if you have not finished preparing the tray for printing, or if you want to make changes before printing it again in the future. *objtf* files are also useful when working from your company's network, where the STL files are stored.

**Note:** Because the *objtf* file references the *stl* files used, they must remain in the same file location as when the *objtf* file was saved.

To save the tray as an *objtf* file:

- In the *Tray Settings* tab, *File* group, click .

To open trays saved as *objtf* files, see "Opening Objet Tray Files" on page 5-13.

### OBJZF Files

To conveniently save all of the files as they are positioned on the build tray, for storing the job, or for transferring it to another location, Objet Studio compresses them into one *objzf* file. To later use the *objzf* file, the file must first be expanded in Objet Studio and its component files saved.

**Note:** If you export an *objzf* file containing a *stl* file originally saved as read-only, you cannot open (import) this *objzf* file to the folder where the read-only *stl* file is saved.

To create an *objzf* file:

1. From the Objet Studio Commands menu , select Export Packed Job. The *Save As* dialog box opens.
2. Select the folder, set the file name, and click Save.

**Note:** You can also export a print job as an *objzf* file from the *Job Manager* screen—see "Additional Server Features" on page 5-76.

To open an *objzf* file:

- Double-click on the *objtf* file.  
or—

1. From the Objet Studio Commands menu , select Import Packed Job.
2. In the *Open* dialog box, display the appropriate folder and select the file.
3. In the *Browse for Folder* dialog box, display the folder in which you want Objet Studio to expand the compressed file, and click OK.

The *objtf* file and associated *stl* files are expanded and placed in the selected folder, and the tray is displayed in Objet Studio.

## Customizing Objet Studio

You can customize Objet Studio to suit your particular working needs and preferences. Features that you can customize include:

- Creating a quick-access toolbar for frequently used commands.
- Changing the position of the Quick Access toolbar.
- Minimizing the ribbon.
- Changing the Objet Studio color theme.
- Configuring default settings for objects placed on the build tray.

### Creating a Quick Access Toolbar

As you work with Objet Studio, you may use certain commands frequently. You can create a quick-access toolbar to make your work easier.

To create a quick-access toolbar:

1. Above the ribbon tabs, click .

The *Customize Quick Access Toolbar* menu opens.

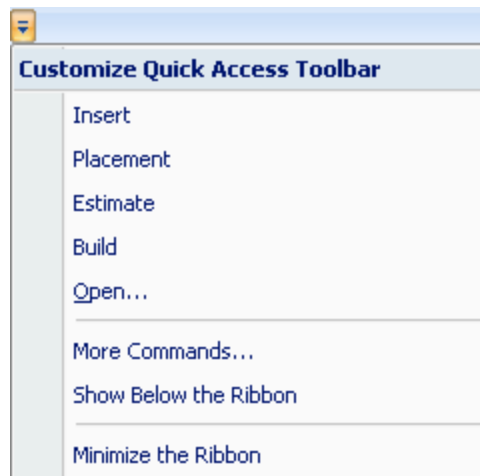

Figure 5-63 *Customize Quick Access Toolbar* menu

2. Select a command you want to add to the toolbar.  
An icon for the selected command is added to the toolbar.

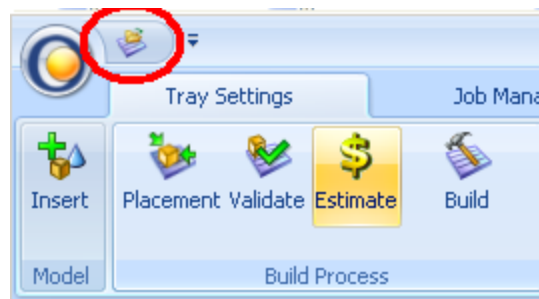



Figure 5-64 Quick Access toolbar

To add another command, repeat the above procedure.

3. To choose from a wider range of commands:
  - From the *Customize Quick Access Toolbar* menu (see Figure 5-63 on the previous page), select *More Commands*.
 or—
  - Right-click on the *Objet Studio Commands* icon , or elsewhere on the ribbon, and select *Customize Quick Access Toolbar*.

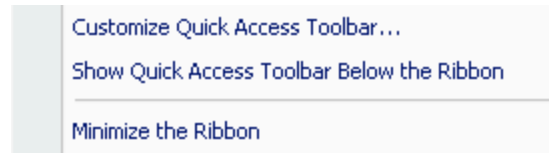

Figure 5-65 Right-click ribbon menu  
The *Options* dialog box opens.

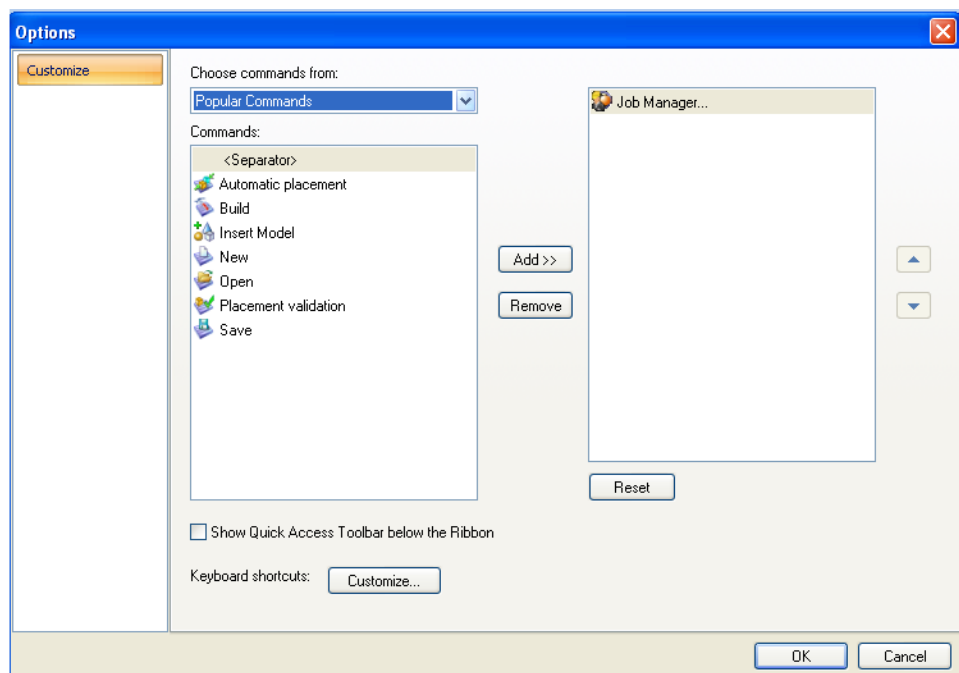

Figure 5-66 Quick Access Toolbar *Options* dialog box

4. Open the drop-down list and select either *Popular Commands* or *Commands not on the Ribbon*.
5. Select a command and click *Add*.
6. Click *OK*.



## Hiding the Ribbon

To make more room for displaying the build tray, you can hide the Objet Studio ribbons.

To hide the ribbons:

1. Right-click anywhere on the ribbon or on the menu bar, or in the Objet Studio Commands menu .
2. Select **Minimize the Ribbon**.

The ribbons disappear, but you can temporarily display the ribbon icons by clicking **Tray Settings** or **Job Manager** on the menu bar. When you next click outside of the ribbon, it disappears again.

To return the permanent ribbon display:

- Repeat the steps above to cancel *Minimize the Ribbon*.

## Display Colors

You can customize some of the colors used for displaying Objet Studio screens and for displaying objects on the build tray.

To change the colors used in Objet Studio screens:

1. From the *Tools* menu, select **Options**.

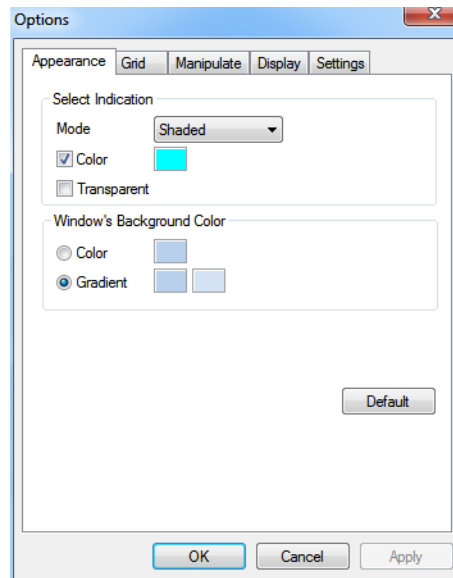

Figure 5-67 Display settings

2. In the *Appearance* tab of the *Options* dialog box, you can configure the display.
  - The *Mode* selection determines how models appear on the build tray. The default method for displaying models on the build tray is as solid (“shaded”) objects. The other options are *WireFrame* and *Points*.

- If *Shaded* is selected, you can display the model on the tray as a see-through object.

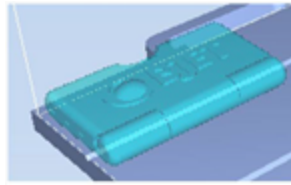

Figure 5-68 Transparent display

- Double-click the color patches to customize colors.
- The *Windows Background Color* settings enable you to change the color behind the build tray—with either a solid or a two-color gradient.
- To return to the default display settings, click Default.

**Changing Color Themes** Objet Studio offers a choice of four background color themes—blue, black, silver and aqua.

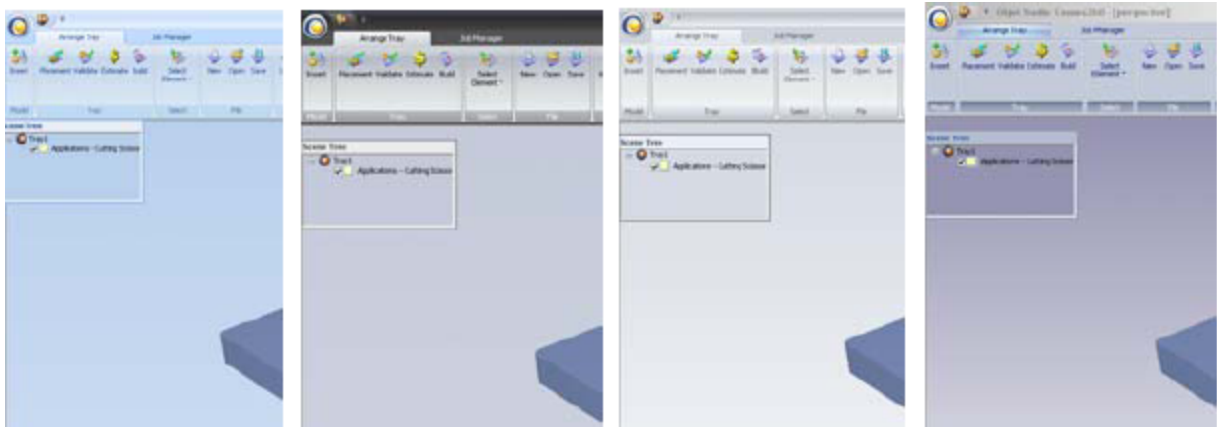

Figure 5-69 Background color themes

To change the color theme:

- From the *Style* menu, select one of the options.

## Keyboard Shortcuts

You can define shortcut keys for frequently used commands.

To define shortcut keys:

1. Above the ribbon tabs, click  .  
The *Customize Quick Access Toolbar* menu opens.

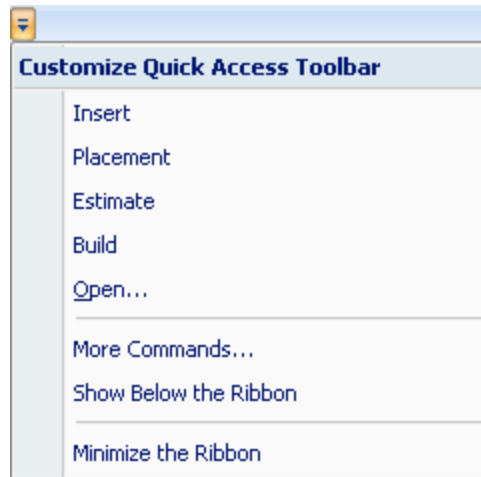

Figure 5-70 *Customize Quick Access Toolbar* menu

2. Select *More Commands*.  
The *Options* dialog box opens (see Figure 5-66 on page 5-50).

3. Click **Customize**.

The *Customize Keyboard* dialog box appears.

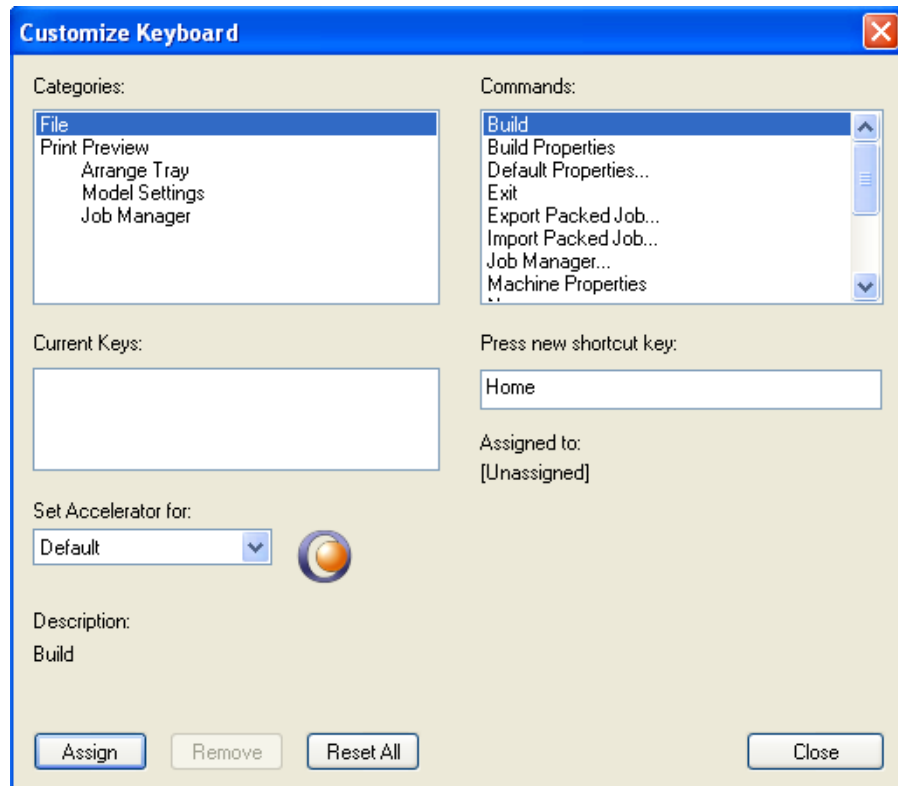



Figure 5-71 *Customize Keyboard* dialog box

4. Select command *Categories* to display all the commands in that category, for example, all the *Model Settings* commands.  
Current shortcut keys are displayed.
5. Enter the shortcut key in the *Press new shortcut key* field, and click **Assign**.
6. If you want to redefine all shortcut keys, click **Reset All**.

## Setting User Preferences

You can change several Objet Studio settings that affect objects placed on the build tray.

To change default settings:

- From the Objet Studio Commands menu , select User Preferences.

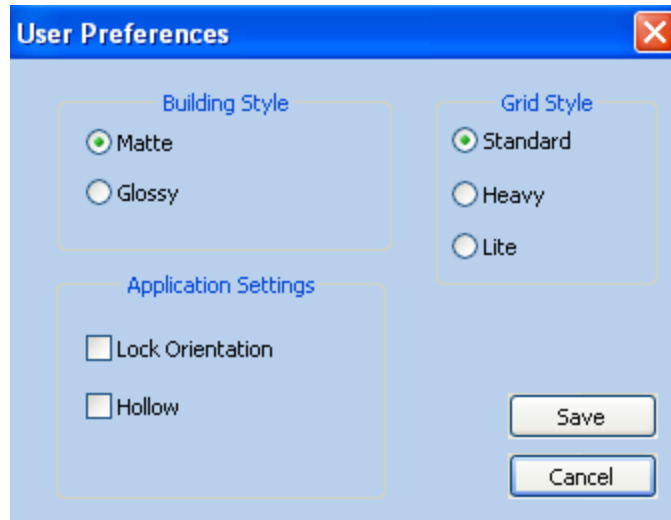

Figure 5-72 Setting work preferences

- Building Style—see "Surface Finish" on page 5-17.
- Grid Style—see "Choosing the Support Strength" on page 5-44.
- Application Settings:
  - Lock Orientation—see "Freezing Model Orientation" on page 5-29.
  - Hollow—see "Hollow"—Filling Models with Support Material on page 5-45.

## Professional Mode Features

Some advanced features of Objet Studio are only accessible in *Professional Mode*.

To see the current Objet Studio setting:

- Open the *Tools* menu.

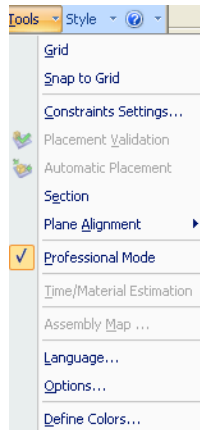

Figure 5-73 *Tools* menu, showing *Professional Mode* selected  
If *Professional Mode* is selected, advanced features are displayed.

To change the *Professional Mode* setting:

1. From the *Tools* menu, select *Professional Mode*.

The following message is displayed, reminding you that the change will only take effect the *next time* you open Objet Studio—even though the check mark next to the *Professional Mode* option appears immediately.

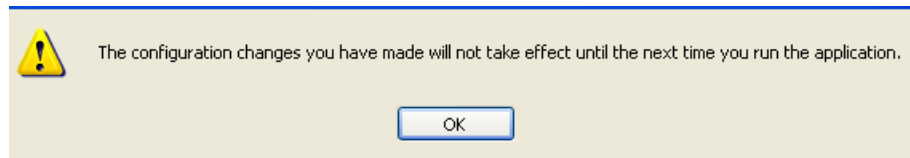

Figure 5-74 Configuration-change message

2. Close and re-open Objet Studio to use the *Professional Mode* features.

## Default Settings

You can control the default settings of several Objet Studio features from the *Advanced* tab of the *Options* dialog box.

To display the Options dialog box

- From the *Tools* menu, select *Options*.
- or—

In the Objet Studio Commands menu , click *Options*.

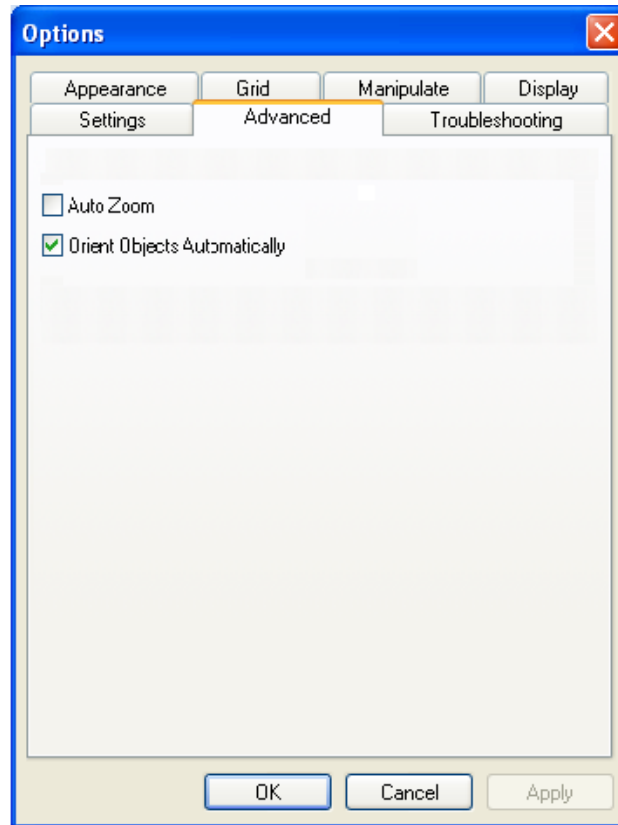

Figure 5-75 *Options* dialog box, *Advanced* tab



The *Advanced* tab is only accessible when Professional Mode is active (see "Professional Mode Features" on the previous page).

## Automatic Orientation

By default, when Objet Studio places objects on the build tray, it orients them optimally, for the shortest printing time. If necessary, you can choose to cancel automatic orientation each time you place an object on the build tray (see "Automatic Orientation" on page 5-18). In any case, when objects are on the build tray, you can change their orientation manually (see "Manual Positioning" on page 5-20.)

To change the default setting so that *Automatic Orientation* is disabled:

- In the *Advanced* section of the *Options* dialog box, clear the check box.

**Automatic Zoom** When *Auto Zoom* is selected in the *Advanced* section of the *Options* dialog box, the display zooms in, to display the objects placed on the build tray. This allows you to carefully inspect and manipulate the objects.

By default, this feature is **not** enabled. In any case, you can change the zoom level, as necessary (see "Zoom Options" on page 5-38).

**OpenGL Driver Configuration** The OpenGL driver displays 3D graphics on your screen. There is normally no reason to adjust its settings. If you suspect a problem with the way Objet Studio displays objects, you can use the OpenGL Driver Configuration tool to check and configure the driver settings.

To access the *OpenGL Driver Configuration* dialog box:

1. From the *Tools* menu, select *Options*.  
or—

In the *Objet Studio Commands* menu , click *Options*.

2. In the *Options* dialog box, display the *Troubleshooting* tab.

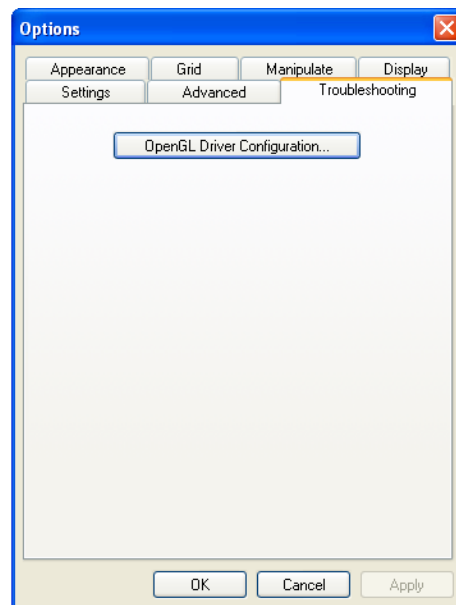

Figure 5-76 Access to OpenGL Driver configuration



The *Troubleshooting* tab is only accessible when *Professional Mode* is active (see "Professional Mode Features" on page 5-56).



3. Click OpenGL Driver Configuration.

The dialog box that opens displays details of the pixel format ID (index) for the window and the memory.

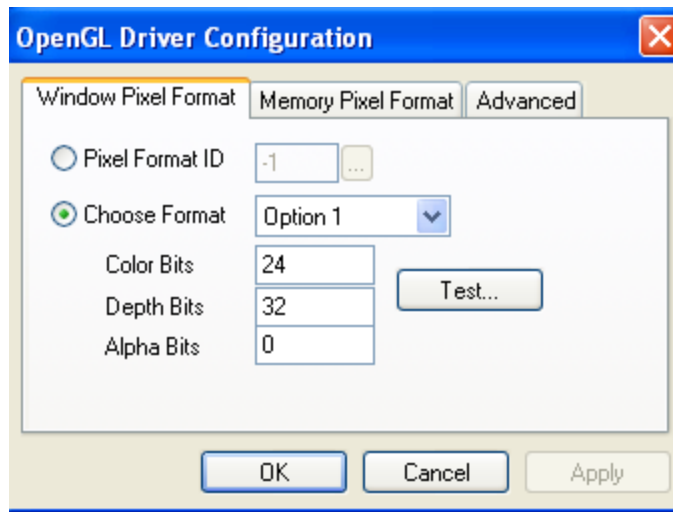



Figure 5-77 OpenGL Driver Configuration dialog box

If you want to display the values and change them, click . Alternately, you can select Choose Format and change the values in this dialog box.

To perform a test of the driver configuration and enter the suggested pixel format ID:

1. Select Choose Format.
2. Click Test.

Objet Studio returns the recommended pixel format ID.

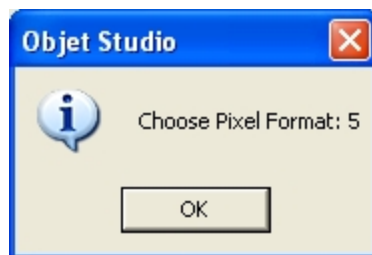

Figure 5-78 Recommended pixel format ID

3. Click OK.
4. In the *OpenGL Driver Configuration* dialog box (Figure 5-77), select Pixel Format ID and enter this number.
5. Click Apply.
6. Display the other pixel format tab, and repeat this procedure.

## Getting Additional Objet Studio Assistance

Objet Studio Help provides on-screen instructions and information, as you work.

To view Objet Studio Help:

- On the standard toolbar, click  and then click Objet Studio Help.

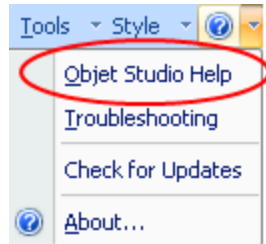

Figure 5-79 Help options

You can also view information on the following subjects:

- Troubleshooting* opens a list of error messages and their explanations.
- Check for Updates* checks if you are using the latest Objet Studio version.

## Objet Studio Version, Material Module and Licensed Features

You can view details of the Objet Studio version, the material module installed, and the features available with your license.

To view details of your Objet Studio installation:

- On the standard toolbar, click  and then click About....

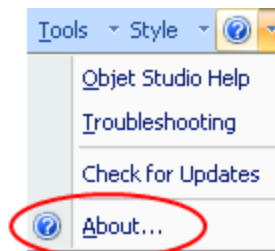

Figure 5-80 Displaying Objet Studio details

**About Objet Studio tab** The *About Objet Studio* tab shows the Objet Studio version number and basic information about your computer.

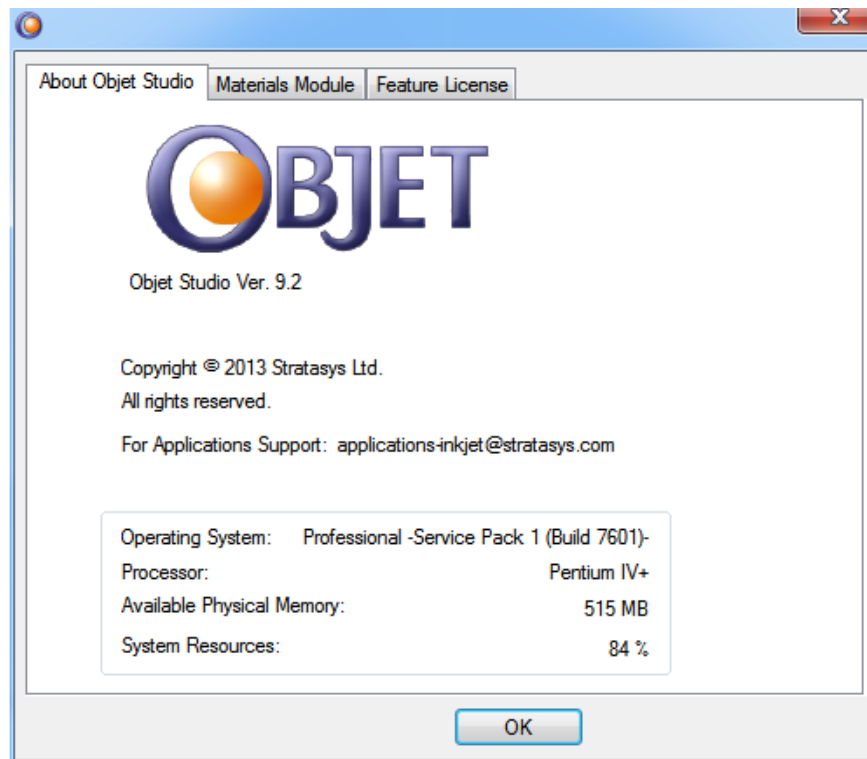

Figure 5-81 About Objet Studio tab

**Materials Module tab** The *Materials Module* tab shows details of the material module installed.

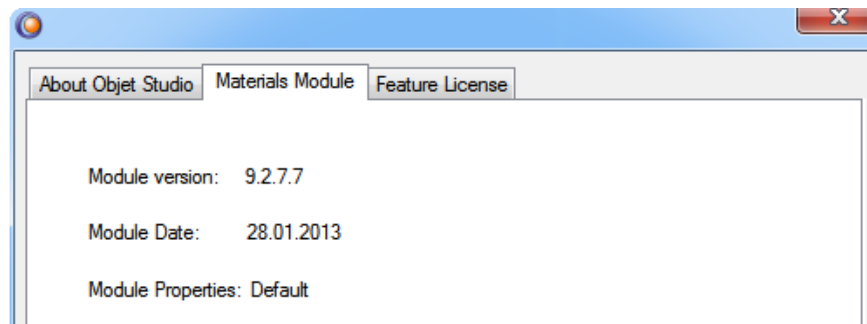

Figure 5-82 Materials Module tab

- *Module version*

If a Materials Module upgrade (patch) was installed, the new Materials Module version is displayed. If no patches were installed, the *Module version* is the same as the Objet Studio version.

- *Module date*

If a Materials Module upgrade (patch) was installed, the date of its creation is displayed. If no patches were installed, the *Module date* is the date of the Objet Studio version.

- *Module properties*

If a Materials Module upgrade (patch) was installed, its description is displayed. If no patches were installed, “Default” is displayed.

**Feature License tab** The *Feature License* tab shows the Objet Studio features available with your license.

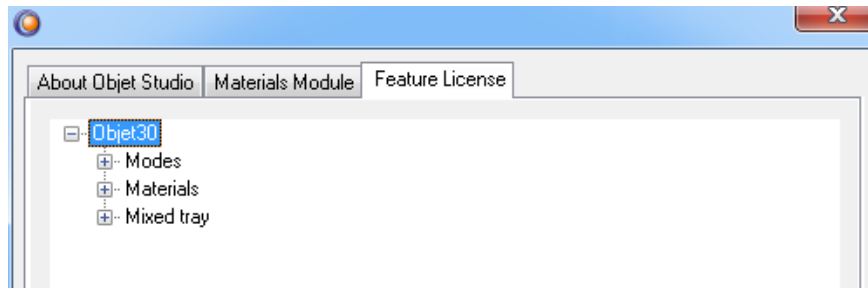



Figure 5-83 Feature License tab

Click  to expand the details for each feature.

- *Modes* shows the printing modes available. See "Printing Modes" on page 5-40.
- *Materials* shows model materials available.

## Monitoring and Managing Print Jobs

In the *Job Manager* screen of Objet Studio, you monitor and manage jobs sent to the printer. There are a few differences between Objet Studio on client workstations and on the computer connected directly to the 3D printer—the server workstation.

- Objet Studio installed on a client computer only displays the queue and status for jobs sent to the 3D printer server from that computer, and it allows the user to edit only these jobs.

**Note:** If there are several PolyJet printers on the local network, client computers can connect to any of them, but only one at a time.

- Objet Studio installed on the computer directly connected to a specific 3D printer (server), displays the queue and status for all jobs sent to that 3D printer by the server and by all client computers on the network. It also allows editing and manipulation of all jobs, and enables re-sending previously-printed jobs to the printer.



If Objet Studio is not connected to a printer (or printer server), you can prepare tray files for any PolyJet printer. Later, these files can be used by Objet Studio on the appropriate printer server.

## Job Manager Screen

The *Job Manager* screen on the client and server workstations looks identical. The only difference is that options only relevant to the server workstation are disabled for client installations.

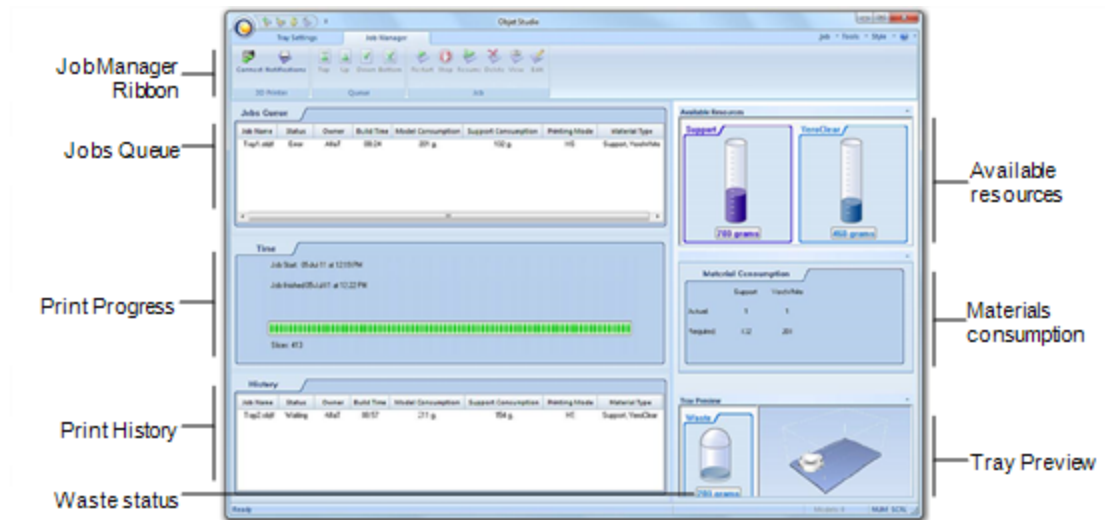

Figure 5-84 *Job Manager* screen

The *Job Manager* screen is divided into panels:

- "Jobs Queue"
- "Printing Progress"
- "History"
- "Available Resources"
- "Material Consumption"
- "Tray Preview"
- "Waste"

**Jobs Queue** On the server, the *Jobs Queue* lists the last 15 jobs sent from client computers. On client workstations, the *Jobs Queue* lists jobs sent from that computer to the printer server.

Information for each of the queued jobs is displayed, including the job status.

Status	Meaning
Waiting	Printing of this job has not started.
Building	Printing of this job is in progress.
Stopped	Printing of this job was interrupted. Printing can later be continued ( <i>Resume</i> ) or begun again ( <i>Restart</i> ).
Error	Errors occurred during the printing of this job, and it was placed in the Jobs Queue again.
Editing	This job is now being edited in Objet Studio.
Spooling	The job file is being spooled in the printer.
Preprocessing	The 3D printer is readying itself for printing: the cover locks, print heads warm up and are put in starting position, UV lamp is turned on, and the build tray level is adjusted.
On Schedule	The job is scheduled to be printed at a specified time.

In addition, the following information is displayed:

- *Owner*—the computer that sent the job
- *Build Time*—the estimated building time for the job
- *Model Consumption*—the amount of model material required to complete the job, and the amount actually used till now
- *Support Consumption*—the amount of support material required to complete the job, and the amount actually used till now

**Printing Progress** The *Time* panel shows printing times and the number of slices sent to the printer.

**History** The *History* panel shows information for the last 50 jobs and their final status. You can drag a job from *History* to *Jobs Queue* to print the tray again.

**Available Resources** The *Available Resources* panel contains graphic indicators that show the amount of available printing materials remaining in the printer.<sup>1</sup>

**Material Consumption**

- *Actual*—the amount of material used till now
- *Required*—the amount of material still needed to finish the job

**Tray Preview** The *Tray Preview* panel displays the build tray view of the job selected in the *Job Queue* or the *History* list.

On a server, you can open an enlarged preview window by clicking on the *Tray Preview* display (see "Additional Server Features" on page 5-76).

---

<sup>1</sup>Objet Studio displays the weight of the printing materials in both cartridges as long as each cartridge contains more than 100 grams of material. The weight under 100 grams is not calculated and displayed. However, if a cartridge contains less than 100 grams of material, the printer uses it—as long as the material in the other cartridge weighs more than 100 grams. In any case, the weight of each cartridge is displayed in the printer application.

**Waste** If you move the mouse over the *Waste* display, the amount of waste in the container is displayed.

### Setting the Printer Connection

When your printer is installed, the server computer is connected to that printer. Normally, there should be no reason to change this connection. Occasionally, however, you may need to reset the connection, to connect the server to another printer, or to use Objet Studio in off-line mode (without a printer connection).

To set (or change) the printer connection:

1. On the *Job Manager* ribbon, in the *3D Printer* group, click .
2. In the *Set Printer* dialog box, click **Connect**.

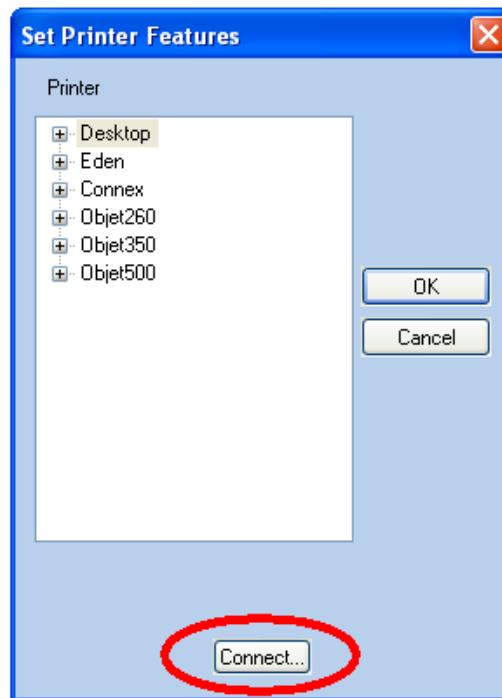

Figure 5-85 Connecting to a printer (A)



3. Enter the computer name or its IP address, or click Browse to find and select it.



Figure 5-86 Connecting to a printer (B)

4. Click OK.

When the connection is established, Objet Studio is configured to prepare print jobs for that printer.



If you can see the material levels in the "Job Manager Screen" (see Figure 5-84 on page 5-64), Objet Studio is connected to the printer.

Normally, there should be no reason to change the printer connection. Occasionally, however, you may need to reset the connection, to connect the server to another printer, or to use Objet Studio in off-line mode (without a printer connection).

Note: A printer can be listed by its name or by its computer's IP address.

### Off-line Mode

You can use Objet Studio to prepare trays for printing in off-line mode, on a remote computer or when the printer connection is not available. You also use off-line mode to prepare trays for printing with other printers. In this case, if Objet Studio is currently connected to a printer, you must change to off-line mode by removing this connection.

To disconnect Objet Studio from the printer:

1. On the *Job Manager* ribbon, in the *3D Printer* group, click .
2. In the *Set Printer* dialog box, click Connect (see Figure 5-85 on page 5-66).

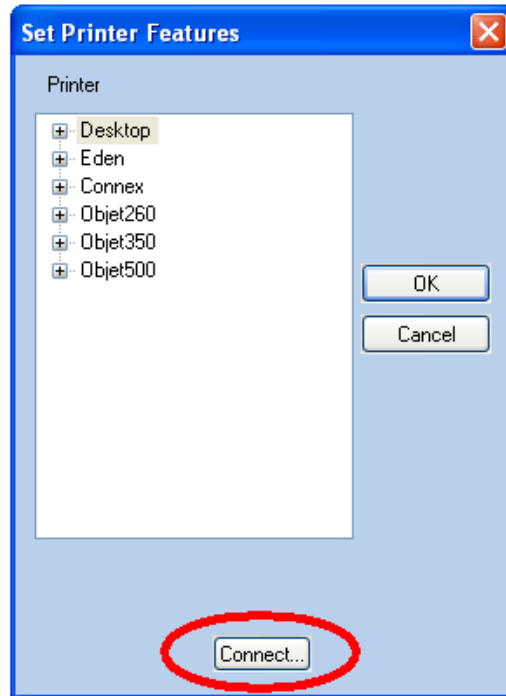

Figure 5-87 Disconnecting Objet Studio from a printer (A)

3. In the *Printer Connection* dialog box, delete the computer name/IP address.



Figure 5-88 Disconnecting Objet Studio from a printer (B)

4. Click OK.  
"Unknown" appears in the printer-name field.
5. Click OK.
6. In the pop-up message, confirm that you want to work in off-line mode by clicking No.

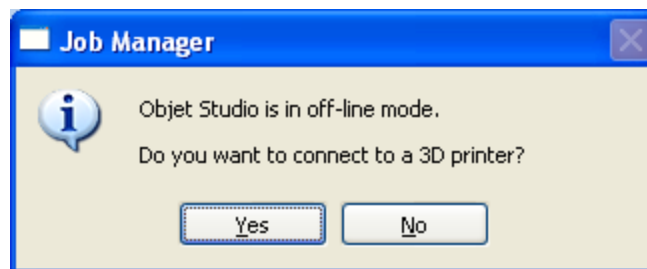

Figure 5-89 Off-line message

When Objet Studio is in off-line mode, you can configure it for preparing print jobs for different printers.

To change the Objet Studio off-line configuration:

1. In the *Set Printer* dialog box, select a printer type.

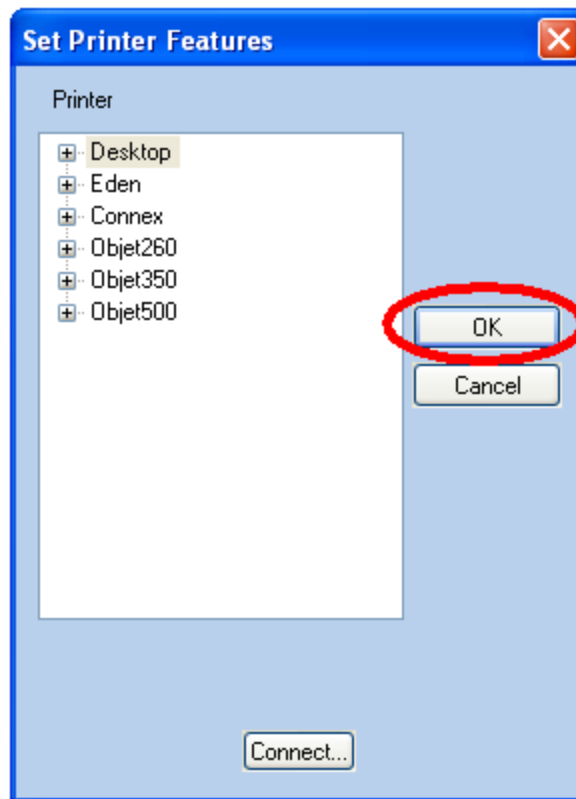



Figure 5-90 Off-line printer selection

2. Click OK (*not* “Connect”).

## Setting the Remote Printer Connection (Client Mode)

When you open Objet Studio for the first time in a client installation, you are prompted to connect to a server computer that sends jobs to a 3D printer. To do this, the server computer must be operating and connected to the local network.

To set (or change) the connection to the server-computer:

1. On the *Job Manager* ribbon, in the *3D Printer* group, click .
2. Enter the name of the server computer or its IP address, or click **Browse** to find and select it.
3. Click **OK**.

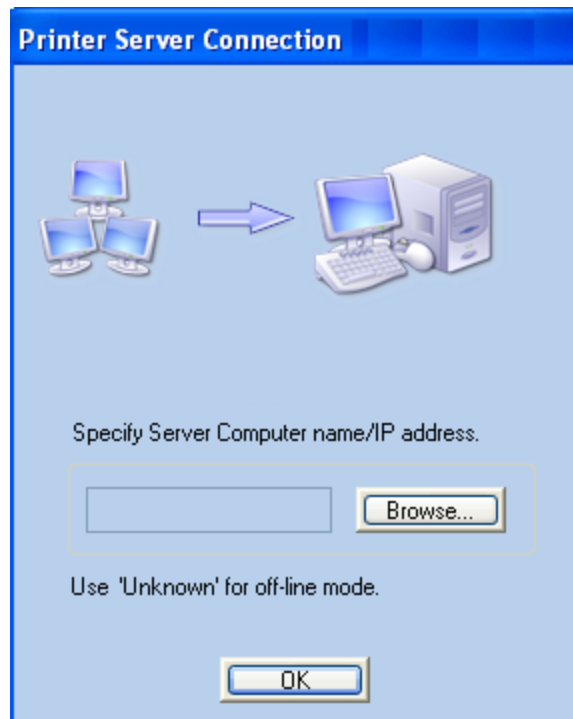

Figure 5-91 *Printer Server Connection* dialog box

## Job Manager Commands

The *Job Manager* ribbon has three icon groups:













- 3D Printer
- Queue
- Job



Figure 5-92 *Job Manager* ribbon commands

Icons are enabled or disabled according to their relevancy. For example, since you cannot stop printing a job that is not being printed, the *Stop* command is disabled when the printer is idle.

The following operations are available on the *Job Manager* ribbon:

Group	Icon	Purpose
3D Printer		<b>Client:</b> Sets the server connection. See "Setting the Remote Printer Connection (Client Mode)" on the previous page. <b>Server:</b> Sets the printer connection. See "Setting the Printer Connection" on page 5-66.
		Configures options for printer alerts. See "Configuring User Alerts" on page 5-74.
Queue		<b>Server:</b> Moves a job to the head of the Jobs Queue. <b>Client:</b> Disabled. See "Jobs Queue" on page 5-65.
		<b>Server:</b> Moves a job to a higher position in the <i>Jobs Queue</i> . <b>Client:</b> Disabled. See "Jobs Queue" on page 5-65
		<b>Server:</b> Moves a job to the bottom of the <i>Jobs Queue</i> . <b>Client:</b> Disabled. See "Jobs Queue" on page 5-65.
		<b>Server:</b> Moves a job to a lower position in the <i>Jobs Queue</i> . <b>Client:</b> Disabled. See "Jobs Queue" on page 5-65.
Job		<b>Server:</b> <ul style="list-style-type: none"> <li>For a job in the <i>Jobs Queue</i>—Prints it again (from the beginning).</li> <li>For a job in the <i>History</i> list—Moves it to the <i>Jobs Queue</i> for printing.</li> </ul> <b>Client:</b> Disabled. See "Restarting Jobs" on page 5-78.
		<b>Server:</b> Stops a job in progress. <b>Client:</b> Disabled
		<b>Server:</b> Continues printing the current job from the point where printing stopped. <b>Client:</b> Disabled. See "Resuming Jobs" on page 5-78.
		Removes the selected job from the queue.
		Refreshes the image of the selected job in the <i>Tray Preview</i> display.
		Opens the <i>Tray Settings</i> screen and displays the tray. For deleted jobs, this enables you to make changes before printing.

In addition to using ribbon command icons, you can use commands on context (pop-up) toolbars and from the *Job* menu on the standard toolbar.



Figure 5-93 Icons on pop-up toolbar (server)



Figure 5-94 Icons on pop-up toolbar (client workstation)

**Note:** Most icons and menu commands are only enabled when a job is selected.



When you position the cursor over an item, a tooltip displays the name of the command.

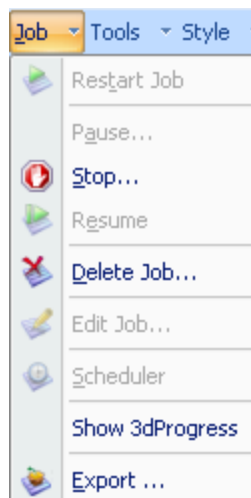

Figure 5-95 *Job* menu options (server)

## Configuring User Alerts

Objet Studio can alert you (and others) to the status of jobs sent to the server for printing. This is especially useful during long printing jobs, when the operator is away from the printer. The following events can be reported:

- The level of model or support material is low.
- The job was interrupted.
- The job was completed successfully.

To send e-mail and SMS alerts, make sure that e-mail software supporting MAPI is installed on the server computer. To send SMS alerts, the cellular phone service must support the transmission of e-mail messages by SMS. Only the subject line of the e-mail message is transmitted by SMS.

To configure Objet Studio to send notifications and alerts:

1. On the *Job Manager* ribbon, in the *3D Printer* group, click  .

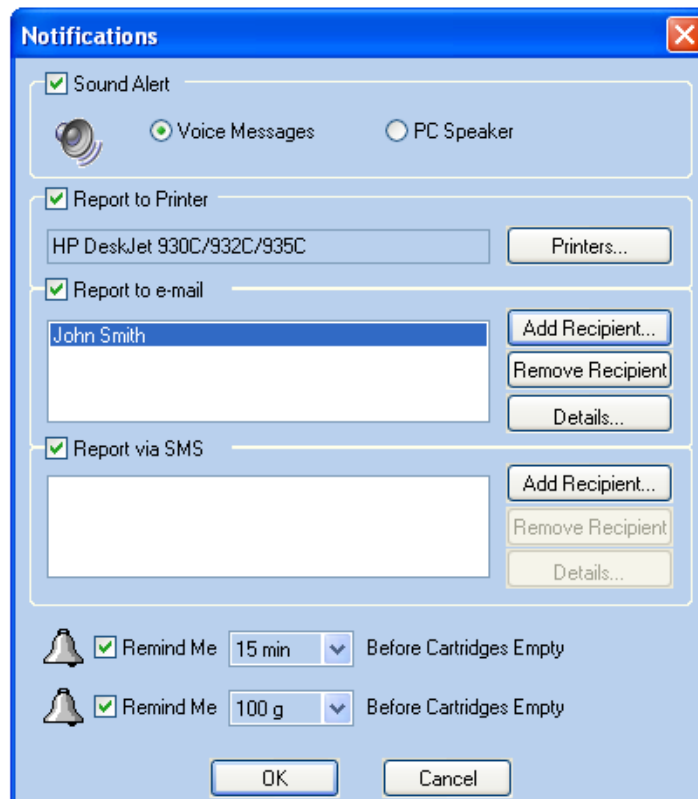

Figure 5-96 *Notifications* dialog box (server)



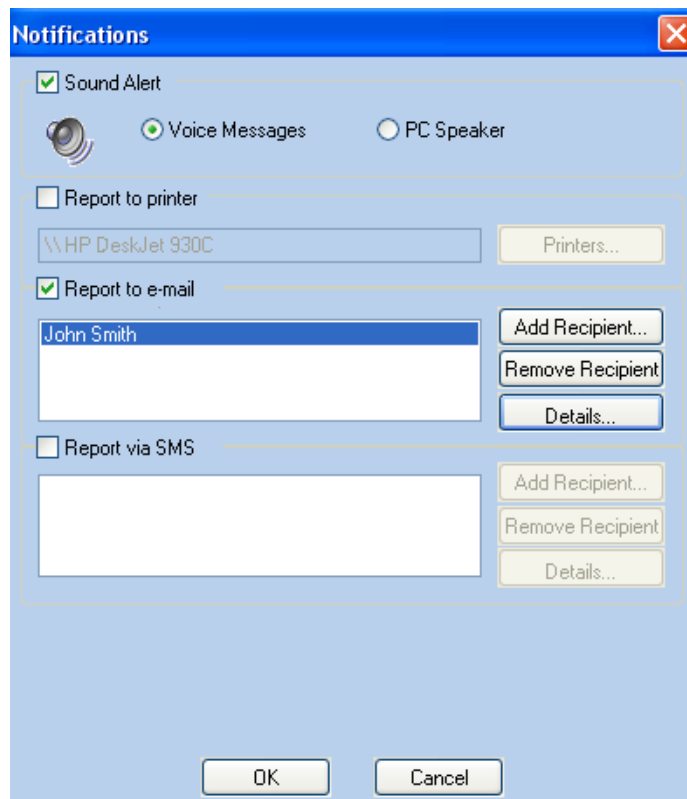

Figure 5-97 *Notifications* dialog box (client workstation)

2. Set the desired reporting options.
3. Click **Details**.



Figure 5-98 Event selection for alerts

4. In the *Reports Events* dialog box, select the alert events and click **OK**.
5. In the *Notifications* dialog box, click **OK**.

### Printing from the Jobs Queue

If there is a job in the Jobs Queue, it is sent automatically to the Stratasys PolyJet printer—as long as it is on, there is a connection to the printer, and the printer is on line.

Chapter 6 describes starting and operating the printer.

## Additional Server Features

Objet Studio on the printer server includes the following additional features:

- "Extended Tray Preview"
- "Editing Jobs"
- "Restarting Jobs"
- "Resuming Jobs"
- "Scheduling Jobs"
- "Exporting Jobs (objzf)"
- "Modifying the Job Manager Screen"

These features are described on the following pages.

### Extended Tray Preview

In this window, you can view the tray from different angles and magnifications without leaving the *Job Manager* screen. In addition to displaying the selected job in the *Tray Preview* pane, you can open an enlarged build tray window.

To display the build tray window:

1. Select a job in the *Jobs Queue* or the *History* list.
2. Click the *Tray Preview* pane.

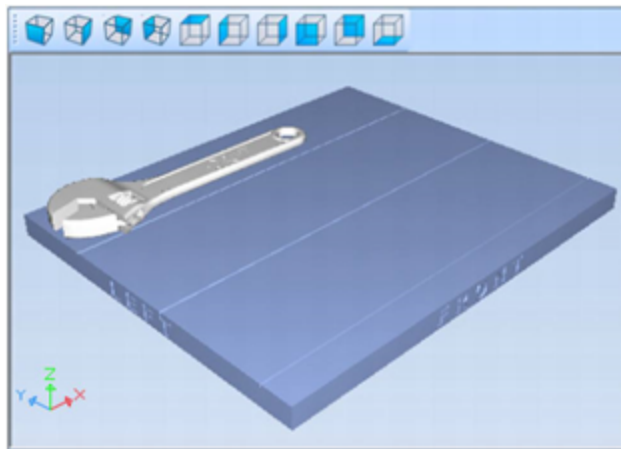

Figure 5-99 Job Preview

- To change the tray magnification, turn the mouse wheel.
- To view the tray from a different perspective, click the relevant icon.
- To resize the window, drag its edge or corners.

If there are several objects on the build tray, you can exclude one or more from being printed, without actually deleting the object from the tray file.

To prevent the printing of an object on the build tray:

1. Double-click on the object you do **not** want to print.
2. Display the *Build* tab.

3. Select Exclude from Build.

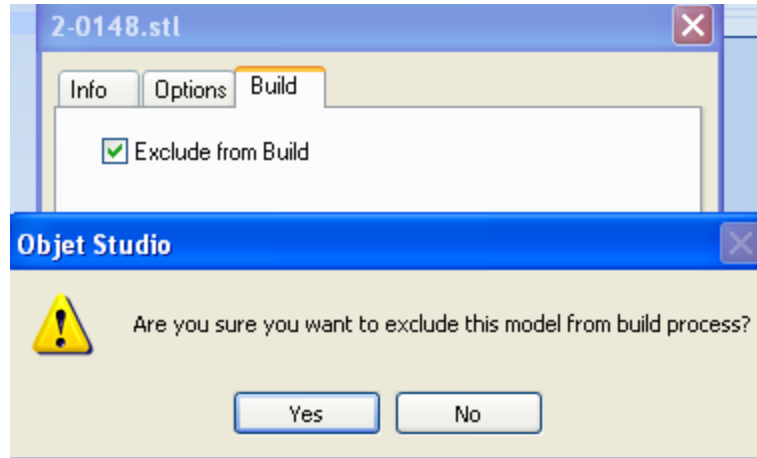

Figure 5-100 Excluding a model from the build

4. Click Yes to confirm.

On server computers, you can use Tray Preview to dynamically display objects as they are printed, layer by layer. This enables you to visually monitor printing progress on the computer screen.

To display printing progress in the Tray Preview pane:

- From the *Job* menu, select Show 3dProgress.



This option uses additional system resources.

## Editing Jobs

You can open jobs in the *Jobs Queue* for editing.

To edit a job:

1. Select the job.

2. Click the *Edit* icon .

The *Tray Settings* screen opens, displaying the build tray. The status of the job in the *Job Manager* screen changes to “Editing.”

3. Edit the job.

4. On the *Tray Settings* ribbon, click .

The status of the job in the *Job Manager* screen changes back to “Waiting.”

## Restarting Jobs

You can restart jobs from the *Jobs Queue* and the *History* list.

To restart a job:

1. Select the job.

2. Click the *Restart* icon  .

The job status changes to “Waiting” (in the *Jobs Queue*).

**Resuming Jobs** If the printing process is stopped or interrupted, you may be able to continue printing the job from the point where printing stopped.

When resuming a print job, the printer tray does not move. The printer expects Objet Studio to send the slice from where the stoppage or failure occurred.

To resume a job:

1. Select the job.

2. Click  .

## Scheduling Jobs

You can schedule jobs to be printed at a future time. For example, you can configure Objet Studio to start long printing jobs in the late evening and early morning hours.

To schedule a job:

1. Select a job in the *Jobs Queue*, and click  on the pop-up toolbar.
2. In the *Scheduler* dialog box, set the Start Date and Start Time for the job. Click on the *Start Date* arrow to open a calendar.

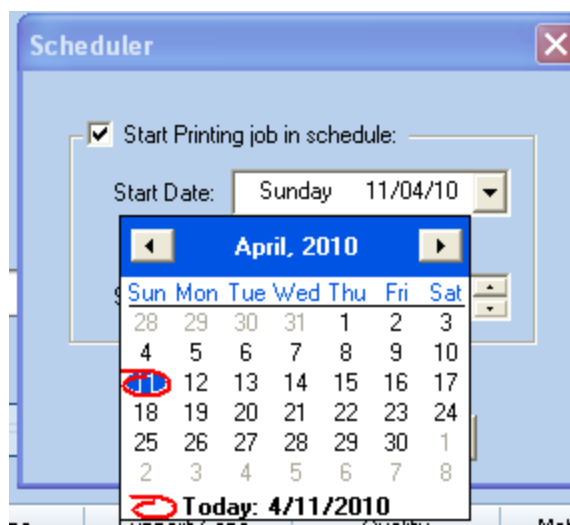

Figure 5-101 Scheduler with calendar displayed

3. Click OK.

## Exporting Jobs (*objzf*)

You can save print jobs as compressed files.



For an explanation of *objzf* files, see "Saving and Importing Build Trays" on page 5-48.

To export a print job:

1. Select a job.
2. On the pop-up toolbar, click  .
3. In the *Save As* dialog box, select a folder.
4. Click *Save*.

## Modifying the Job Manager Screen

You can change the size of the sections of the *Job Manager* screen, by dragging the panel edges. This applies to:

- the *Jobs Queue* panel
- the *Time* panel
- the *History* panel

Similarly, you can change the way the screen area is divided between the main section (*Jobs Queue/Time/History*) and the panels on the right side of the screen.

You can collapse (hide) the right panels (*Available Resources/Material Consumption/Tray View*) by clicking the top of the panel.

- Click again to display the panel.

# 6

## Operating and Maintaining the Objet30 3D Printer

Starting the Printer .....	6-3
Loading Model and Support Cartridges .....	6-5
Producing Models .....	6-7
Preparing the Printer .....	6-7
Printer Interface Color Key .....	6-10
Printing Indicators .....	6-11
Resuming Production After Printing has Stopped .....	6-12
Changing the Printing Material .....	6-14
Keeping the Printer in Idle Mode .....	6-20
Shutting Down the Printer .....	6-21
Shutdown Wizard .....	6-22
Material Flush/Fill Wizard .....	6-24
Maintaining the Printer .....	6-27
Routine Maintenance Schedule .....	6-27
Cleaning the Print Heads and the Roller .....	6-28
Cleaning and Replacing the Wiper .....	6-31
Pattern Test .....	6-33
Improving Print Quality .....	6-35
Cleaning and Replacing the Roller Waste Collector .....	6-36
Aligning the Print Heads .....	6-39
Optimizing (Calibrating) Print Heads .....	6-43
Replacing Print Heads .....	6-51
Testing and Calibrating the UV Lamp .....	6-62
Calibrating the Load Cells .....	6-65
Replacing the Odor Filter .....	6-67
Replacing the UV Lamp .....	6-68
Replacing the Material Filter .....	6-73

Replacing the Pump Tubes .....	6-82
Built-in Tests .....	6-93
Replacing the Waste Container .....	6-95
Cleaning the Exterior Panels .....	6-97
Backing-Up and Restoring Printer Settings .....	6-98
ReInitiate Wizard .....	6-98
Preventive Maintenance Tasks .....	6-98



Figure 6-1 The Objet30 3D Printer

## Starting the Printer



### Caution

- Do not attempt to operate the printer before being trained by a Stratasys Customer Support representative.
- Observe all safety warnings and follow the safety guidelines described in Chapter 2.

1. Turn on the main power switch, located at the back of the printer.



Figure 6-2 Main power switch and cable

The main power switch turns on the Objet30 printer, which includes — the built-in computer.



- After the computer boots, open the Remote Desktop Connection on the server (“host”) computer, by double-clicking the *Printer computer* shortcut.



A HASP plug containing a valid product activation key is required on the printer computer. This is installed at the factory or during printer upgrade. If the application does not open and a HASP message appears, contact your dealer or Stratasys Customer Support.

The Objet printer interface screen opens. All monitoring and controlling of the printer is done from this interface.

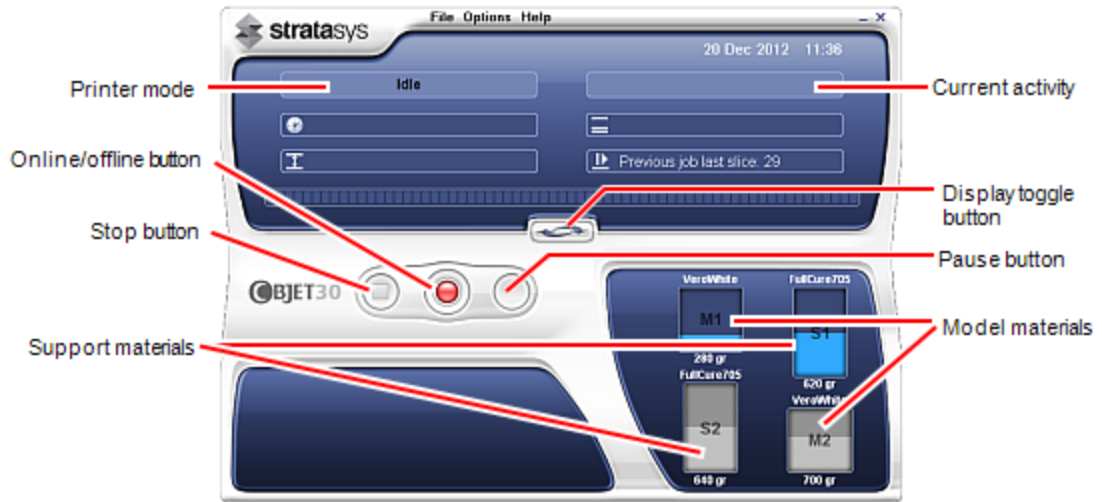

Figure 6-3 Objet30 interface



The time zone on the printer computer is factory-set and it cannot be changed. Similarly, the computer’s clock cannot be configured to automatically change the time for different seasons of the year. If necessary, you can change the displayed time manually, but do so only when the printer is idle.

## Loading Model and Support Cartridges

Objet30 printers use two cartridges of Model material and two cartridges of Support material, each weighing one kilogram when full. A graphical representation of the cartridges loaded and their current weight appears in the printer interface (see Figure 6-3 on the previous page).

**Note:** The printer-control interface displays the type and weight of the material cartridges loaded only if the materials drawer is closed.



The printer uses RFID technology to automatically identify cartridges of printing material. For this purpose, an RFID module is part of the printer hardware. Tampering with this module will render the printer inoperable and may void Strasas warranties and service contracts.

**Important:** If you need to replace the Model material currently installed with another type, see "Changing the Printing Material" on page 6-14. Otherwise, make sure to replace the Model cartridge with one containing the same type of material.

To load Model and Support material:

1. On the front of the printer (see Figure 3-1 on page 3-2), push the materials drawer to release it and pull it open.
2. If you are replacing a cartridge, remove the old one by pulling it straight up.
3. Load Model and Support cartridges into their respective compartments (see Figure 6-4).



Figure 6-4 Materials drawer

4. Close the materials drawer.

5. Check the printer interface to make sure that the new cartridge is detected and that its weight is displayed (see Figure 6-3 on page 6-4).

Tips about loading and replacing material cartridges:

- It is recommended that you always have two material cartridges loaded in the printer. When the weight of the material in one cartridge drops below 100 grams, the printer pumps material from both cartridges until one is empty. If only one cartridge is used, printing stops when the weight of the material drops below 100 grams. (Similarly, printing stops if the weight in both cartridges is below this level.)

**Note:** Objet Studio does not display the weight of material in a cartridge if it is under 100 grams.

- You can replace material cartridges either before or during printing. If you do so while printing, make sure to load the new cartridge and close the materials drawer within three minutes. This ensures that the print job is not interrupted. (When the drawer is open, the cartridges are not displayed in the printer interface.)
- If printing stops for an extended time before you replace a material cartridge, the printer may go into *Standby* or *Idle* mode. If this happens, see "Resuming Production After Printing has Stopped" on page 6-12.
- You can replace a partially used cartridge to avoid the need for replacing them during printing. However, repeated removal and installation of a cartridge may cause the material in it to leak. Therefore, it is recommended that you limit the re-installation of used cartridges.
- The cartridge type is automatically detected by the printer. If you replace a cartridge containing different Model material, a message appears recommending that you run the Material Replacement wizard to flush out the old material.

## Producing Models

The Objet30 printer produces models after they are arranged on a virtual build tray in the Objet Studio application and sent to the printer from there. For information about preparing model files for printing, see "Using Objet Studio" in this user guide or Objet Studio Help.

The Objet30 printer is capable of printing models with the following maximum dimensions:

➤ *With glossy finish—*

X-axis: 294.00 mm (11.57 inches)

Y-axis: 192.00 mm (7.55 inches)

Z-axis: 148.60 mm (5.85 inches)\*

\* OrthoDesk printers—100.0 mm (3.94 inches)

➤ *With matte finish—*

X-axis: 293.00 mm (11.53 inches)

Y-axis: 191.00 mm (7.52 inches)

Z-axis: 148.30 mm (5.83 inches)\*

\* OrthoDesk printers—97.9 mm (3.85 inches)

### Preparing the Printer



Before beginning to produce models, it is recommended that you check the current printing quality of the print heads by performing a pattern test (see "Pattern Test" on page 6-33).

To prepare the printer for producing models:

1. Make sure that the build tray in the printer is empty and clean. If not, remove cured material with the scraper, and clean the tray thoroughly with a wet cleaning cloth.



#### Caution

Use protective gloves when cleaning the build tray, and be careful of the sharp edges of the scraper blade.

2. Make sure that there is sufficient Model and Support material loaded, as indicated on the printer interface (see Figure 6-3 on page 6-4). You may want to replace the cartridges of Model and Support material currently loaded in the printer to avoid the need for replacing them during printing.

For installing material cartridges and replacing empty ones, see "Loading Model and Support Cartridges" on page 6-5.

3. On the printer interface, click the red button to switch the printer to *online* mode.

The color of the button changes from red to green (see Figure 6-7 on the next page). If there is a job in the Job Manager queue, it is sent to the printer.

When switching the printer to online mode, a message is displayed if a maintenance activity is required to ensure optimum printing quality. (See "Routine Maintenance Schedule" on page 6-27.) Maintenance notifications can be disabled/enabled from the Options menu.

On the printer interface, the printer mode changes from *Idle* to *Pre-print*, as the printer's components prepare themselves for production:

- The print block is heated.
- If more than 48 hours have passed since the last print job, the printing materials in the print heads are flushed and replaced, to ensure quality printing. (This step adds 7 to 14 minutes to the *Pre-print* cycle, and it is displayed on the printer interface.)



Figure 6-5 Relinitiate process during the Pre-Print cycle

- The UV lamp is powered and it warms up.

When printing begins, Objet Studio sends seven slices to the printer-control application. This is the standard buffer between Objet Studio and the printer. As each slice is printed, another slice is sent to the printer.

Depending on the size of the model(s) to be produced, printing can take between several hours to several days. As long as there is enough Model and Support material in the supply cartridges, printing proceeds automatically until the job is finished.



During printing, the server computer must remain on and it must communicate with the Objet30 printer. Do not log-off Windows until printing is finished.

The Objet30 printer uses one Model-material cartridge and one Support-material cartridge to produce models. When four cartridges are loaded in the printer, two of them are reserve, or standby, cartridges. By default, the printer first uses the cartridges with the least material in them.

- The active cartridges are *blue* on the printer interface.

When the weight of a cartridge drops below 200 grams, the remaining material displayed on the printer interface is *red*.

When the weight of a cartridge drops below 100 grams, the printer alternates the pumping of material between the heavier and the almost-empty cartridge. This is indicated on the printer interface by an hour-glass icon. (See Figure 6-8 on page 6-11.)

When a cartridge is completely empty, a trash icon is displayed.



Figure 6-6 Empty cartridge indicator

You can monitor printer status indicators by switching the printer interface display. To do this, click the display toggle button on the printer interface screen.



Figure 6-7 Printer indicators

## Printer Interface Color Key

The background colors in the printer indicator fields tell you at a glance whether or not the value or item is suitable or ready for printing.

- *Green*—suitable/ready for printing

For example, in Figure 6-7 on the previous page:

- Ambient*—The ambient temperature of the printing chamber is within the acceptable range.
- Heads Liquid*—The level of Model and Support material in the print-block reservoir is OK.
- Vacuum*—The vacuum level in the system is within the acceptable range.

- *Red*—not suitable for printing (or indicates a warning)

For example, in Figure 6-7 on the previous page:

- Waste*—The weight of the waste container is 1520 grams, more than allowed when beginning a print job. ("Replacing the Waste Container" on page 6-95.)

- *Blue*—not ready

For example, in Figure 6-7 on the previous page:

- UV lamp*—The UV lamp is not on.
- Heads (°C)*—The heads have not reached the temperature required for printing models (in printing mode).

The color of the material cartridges displayed in the printer interface indicates which cartridges are active for the current (or next) print job.

- *Blue*—active cartridges
- *Gray*—reserve cartridges

## Printing Indicators

The printer interface screen changes when you send a print job to the printer (from Objet Studio), if the printer is *on line*:

- The mode changes from *Pre-print* to *Printing*.
- The specific activity being performed is shown in the “current activity” field.
- Current job-printing information is displayed.
- The printing progress bar is displayed.
- The *Stop* button is enabled.

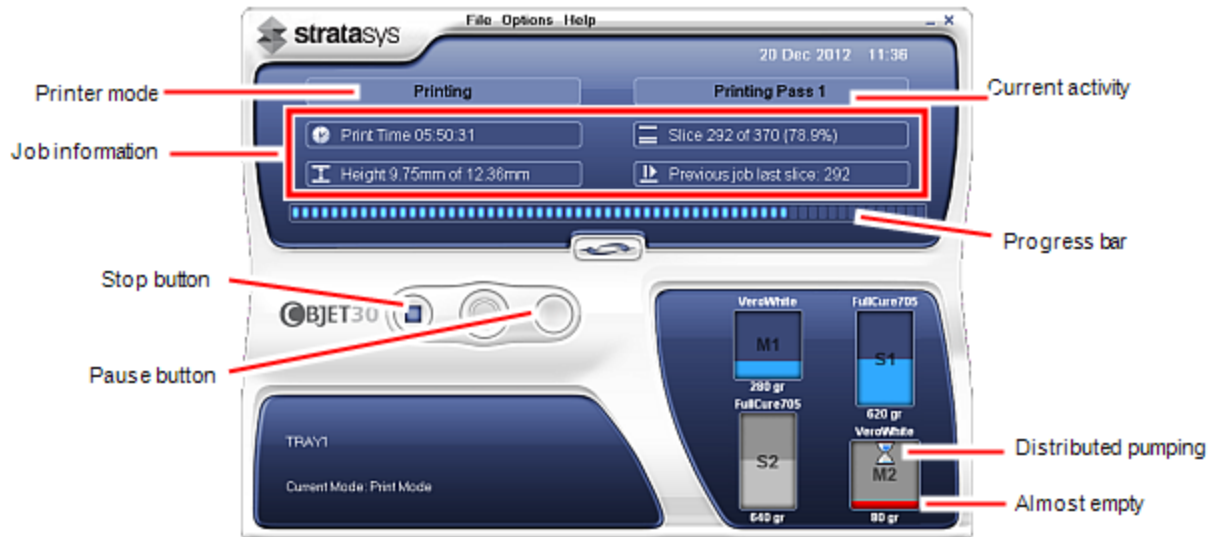

Figure 6-8 Printer interface during printing

During printer operation, the following window may occasionally appear.

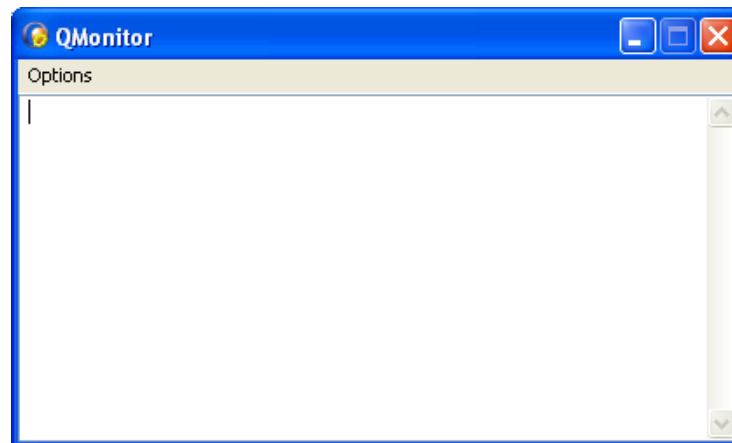

Figure 6-9 Q-Monitor

This window records information for service personnel only, and it does not require your attention. You can close or minimize it to remove it from view.



## Resuming Production After Printing has Stopped

If the printing process is interrupted, Job Manager stops sending slices to the printer. This can happen, for example, if the printing material runs out in the middle of a print job, and you do not replace the empty cartridge immediately. After the printer changes to *Standby* or *Idle* mode, you need to resume printing from the *Job Manager* screen of Objet Studio.



After printing stops, the printer goes into *Standby* mode, when heating of the print heads is reduced. About 20 minutes later, the printer goes into *Idle* mode, when heating of the print heads is stopped.

To continue printing the model:

1. If the printer is in offline mode, switch it to online mode by clicking the red button at the bottom of the printer interface (see Figure 6-3 on page 6-4).  
The button changes from red to green (see Figure 6-3 on page 6-4).
2. If you don't know why printing has stopped, make sure that the connection between the printer and the server computer is active.
3. In the *Job Manager* screen of Objet Studio, click the *Resume* icon .
4. In the *Continue from Slice* dialog box that appears, confirm the slice number, after checking the printer interface.

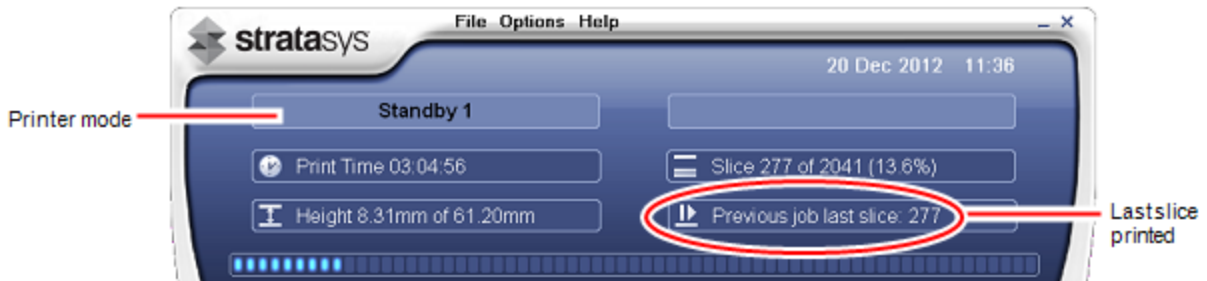

Figure 6-10 Printer interface after interrupted printing

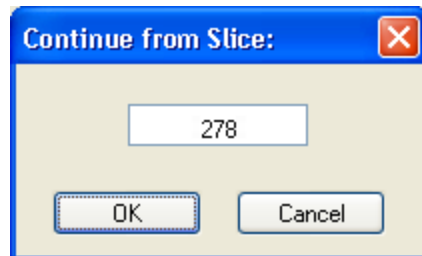

Figure 6-11 *Continue from Slice* confirmation in Objet Studio (*Job Manager* screen)

5. If, for any reason, the correct number does not appear in the dialog box, enter the number and click OK.

You cannot continue printing the model if:

- The number of the last slice printed does not appear in the printer interface, even if the server computer displays the *Continue from Slice* confirmation dialog box.
- There was a relatively long interruption in printing, even if the “last slice” and “continue from slice” indicators are correct. The part of the model already printed may deform or shrink, and there might be a visible difference between it and the newly printed part. The effects of a printing stoppage on a model depend on the model size and structure, Model material used, ambient temperature and the length of the stoppage.

If you cannot continue printing:

1. Cancel the print job in the *Job Manager* screen.
2. Remove the partially printed model from the build tray.
3. Restart the job from the *Job Manager* screen (in Objet Studio).



You can stop printing from either the printer interface or from the *Job Manager* screen of Objet Studio. Resuming printing is only available from the *Job Manager* screen.

## Changing the Printing Material

When you want to produce models with a different type of printing material than is currently installed, run the Material Replacement wizard to flush out the current material from the print block and feed tubes. However, if the type of material used for printing the new models is unimportant, you can replace the material cartridge without first flushing out the old material.



When changing the type of Support material, run the Material Replacement wizard and the Head Optimization wizard to ensure quality printing results. (After changing Support material with the wizard, Head Optimization is required before printing models.)



You should carefully plan printing models with different Model materials to avoid unnecessary waste of the materials currently loaded. The amount of material flushed depends on the flushing cycle chosen and if you are replacing one or both Model cartridges. For details, see Flushing Options.

To replace the printing material with the wizard:

1. Start the Material Replacement wizard from the *Options* menu.

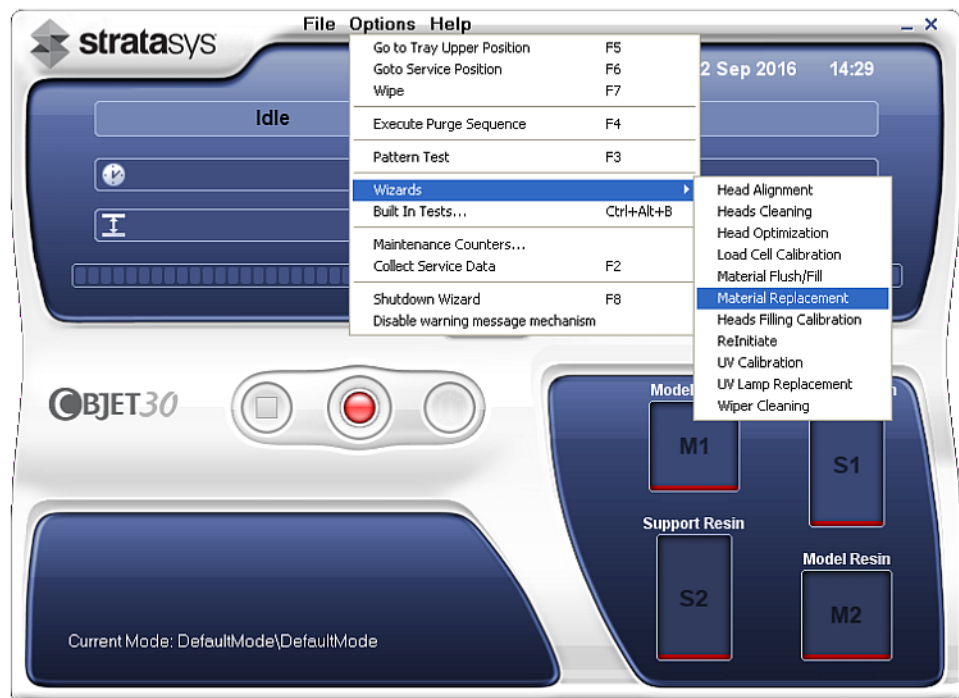

Figure 6-12 Starting the Material Replacement wizard

2. In the opening screen, click Next.
3. If the printer cover is not closed, a screen appears, prompting you to close the cover. Confirm that it is closed and click Next.

4. When the *Cartridge Loading* screen appears, indicate whether or not replacement cartridges have been loaded.

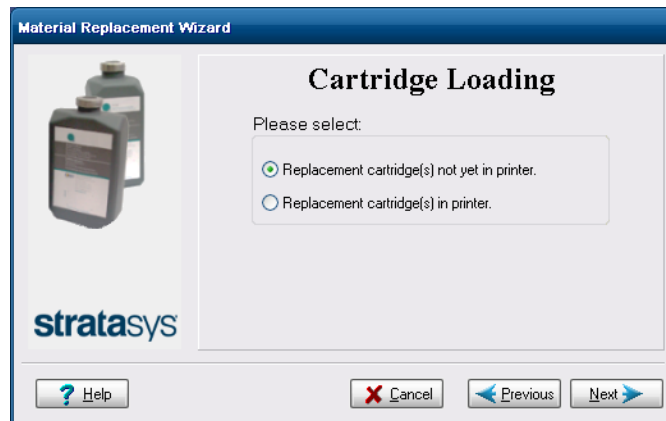

Figure 6-13 Replacement-cartridge status

5. Click Next.
  - If the replacement cartridges are already loaded in the materials drawer, a screen appears, showing the materials currently in the system and the material cartridges in the drawer.



Figure 6-14 *Material Replacement Summary* screen

After reviewing this screen, click **Next** and continue with **step 8**.

- ❑ If the replacement cartridges are *not* loaded in the materials drawer, the Compartment Selection screen appears.



Figure 6-15 Compartment selection screen

6. Select the cartridge(s) you want to replace, and click Next.
7. In the next screen, from the drop-down menu, choose the material you want to install, and click Next.

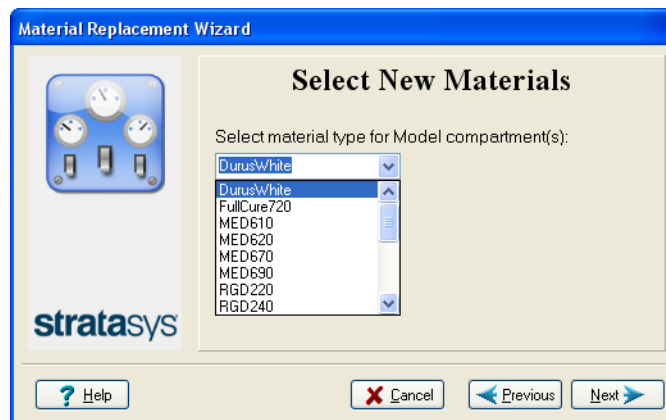

Figure 6-16 Material selection screen



The Model materials available for selection depend on your printer type and license.

8. In the *Flushing Options* screen, choose the appropriate cycle for the Model material you want to install.



Figure 6-17 Flushing options screen

- *Economy*. During this cycle, which takes about 25 minutes, the pump purges the Model material from the print block, then flushes the system with the new material.

Since traces of the previous material may be present in the first models printed with the new material, this cycle is usually acceptable when replacing a light-colored Model material with a darker material (such as TangoBlack™ or VeroBlack™), or if the exact color of the printed models is unimportant. In most cases, models will have the mechanical properties of the new material (except when switching between Vero and Tango materials).

The amount of material flushed during this cycle is—

- ✕ 65 grams ( $\pm 10\%$ ) when replacing one cartridge
- ✕ 110 grams ( $\pm 10\%$ ) when replacing two cartridges

- *High-performance*. During this cycle, which takes about 60 minutes, the wizard cleans the feed tubes and print block more thoroughly, compared to the *Economy* cycle, by flushing the system with more material.

This cycle ensures that models will have both color and mechanical properties of the new material. This is important when replacing a dark-colored material (such as VeroBlack or TangoBlack) with a lighter-colored material, and when switching between Vero and Tango materials. This cycle is also recommended when changing the type of Support material.

The amount of material flushed during this cycle is—

- ✕ 300 grams ( $\pm 10\%$ ) when replacing one cartridge
- ✕ 450 grams ( $\pm 10\%$ ) when replacing two cartridges

9. Click Next, and take note of the warning.

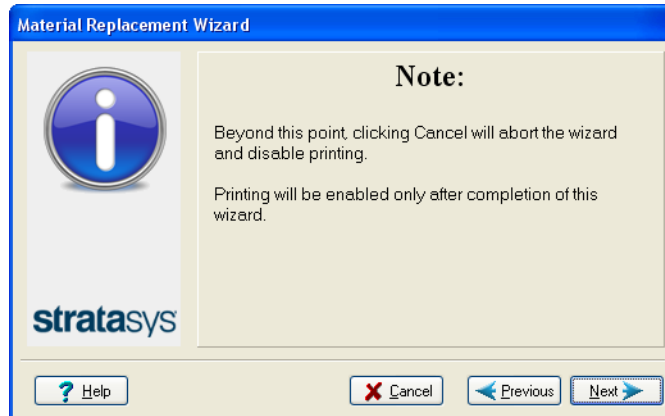

Figure 6-18 Material Replacement warning screen



Once you start this procedure, you must complete it before you can produce models with the Objet printer. To perform the procedure at another time, click **Cancel**. If you continue (by clicking **Next**) and you do not complete the procedure, you must start the Material Replacement wizard again before producing models.

10. Click Next.

- If the replacement cartridges are already loaded in the materials drawer, the wizard checks that there is sufficient material to complete the procedure. *Continue with step 7.*
- If the replacement cartridges are *not* loaded in the materials drawer, the wizard prompts you to remove the cartridge(s) from the drawer. *Continue with step 11.*

11. When prompted by the wizard screen, remove the material cartridge(s). Confirm this in the wizard screen and click Next.



Figure 6-19 Remove Cartridge confirmation screen

12. When prompted, load the new cartridge(s) and close the drawer. Confirm this in the wizard screen and click Next.

The wizard identifies the cartridge(s) and verifies that there is sufficient material to complete the procedure.

13. After checking the amount of material in the cartridges, the wizard proceeds as follows:
  - If the amount of material is insufficient for completing the procedure, the wizard prompts you to replace the cartridge(s).



Figure 6-20 Prompt to replace cartridge due to insufficient material

Replace the required cartridge(s). Confirm this in the wizard screen and click Next.

- If the amount of material is sufficient for completing the procedure, the printer purges the current material from the system, then flushes the system and fills the print heads with the new material.

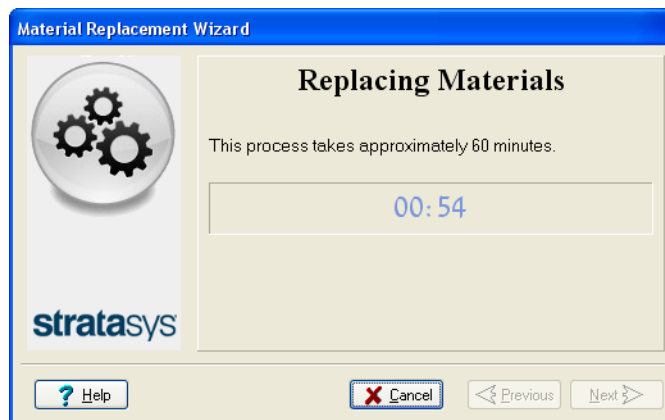

Figure 6-21 Material replacement: filling heads with new material

14. Click Done to close the wizard.

The printer-control application is automatically updated, and the interface displays the new material(s). Objet Studio (on the server computer) is also updated and displays the new material(s).

15. Inspect the area around the purge unit and clean it, if necessary.



### Caution

Dispose of all material cartridges in accordance with all applicable laws and regulations. If necessary, the cartridges can be disassembled for recycling. If this is done, protect the person handling the cartridges from direct exposure to uncured resins.





After changing the type of Support material (SUP705/706), you need to run the Head Optimization wizard before printing models. See "Optimizing (Calibrating) Print Heads" on page 6-43.

## Keeping the Printer in Idle Mode

Between printing jobs, the Objet30 printer can be left unused for up to one week. If the printer will not be used for more than a week, use the Shutdown wizard to automatically perform the procedures that must be done before turning off the printer (see "Shutting Down the Printer", below).

When the printer stops producing models, the printer software automatically reduces the temperature of the print heads as follows:

After printing stops	Mode	Change in heating of print heads
first 15 minutes	Standby 1	no change
next 5 minutes	Standby 2	heating reduced (to room temp.)
after Standby 2	Idle	heating stopped

**Note:** The printer mode is indicated in the green field on the left of the interface (see Figure 6-3, and Figure 6-8 on pages 6-4, and 6-11).

If, after printing a job, you know that the printer will not be used for 20 minutes or more, you can immediately turn off the heating of the print heads by putting the printer into Idle mode.

To put the printer into Idle mode:

- From the *File* menu (in the printer interface) click Exit.

**Note:** The printer remains in Idle mode until you open the Objet30 printer application and begin printing again.



When the printer is in Idle mode, do **not** turn it off. It can remain in this mode—with the cover closed—for up to a week. For longer periods, shut down the printer by running the Shutdown wizard (see below).

## Shutting Down the Printer

You only need to shut down the Objet30 printer if it will not be used for a week or more. Otherwise, the printer can remain on, in *Idle* mode.



The Shutdown process flushes printing materials from printer components. To avoid flushing out valuable material, make sure to print models at least once a week. Many printer operators use this opportunity to print customer samples or test models.

To properly shut down, the printer needs to perform several processes. **Do not attempt to shut down the printer by simply closing the computer interface (the printer-control application), and never disconnect power to the printer before completing the Shutdown wizard.**



### Caution

Not using the printer for an extended period without first running the wizard can cause serious damage to print heads and other expensive printer parts.

- **Shutdown for Less Than One Week**

Before shutting down the printer or the printer computer for less than one week, run the "Shutdown Wizard". This wizard clears the print heads of printing materials before shutdown.

- **Shutdown for One Week or More**

Before shutting down the printer or the printer computer for one week or more, first run the "Material Flush/Fill Wizard". This wizard replaces printing materials in the print block with cleaning fluid.

**Note:** After preparing the printer with the Material Flush/Fill wizard, you must run it again before printing models, this time to replace the cleaning fluid in the print block with printing materials.)

## Shutdown Wizard

To run the Shutdown wizard:

1. Select Shutdown wizard from the *Options* menu, or press F8.



Figure 6-22 Shutdown wizard, opening screen

2. Select Run wizard unattended, unless you want more control over the shutdown process.

**Note:** If you select *Run wizard unattended*, the wizard automatically turns off the printer computer at the end of the process.

3. Click Next.

The options in the following screens are enabled only if you selected *Run wizard manually* in the opening wizard screen.

4. In the next screen, indicate whether or not the tray is empty and click Next.

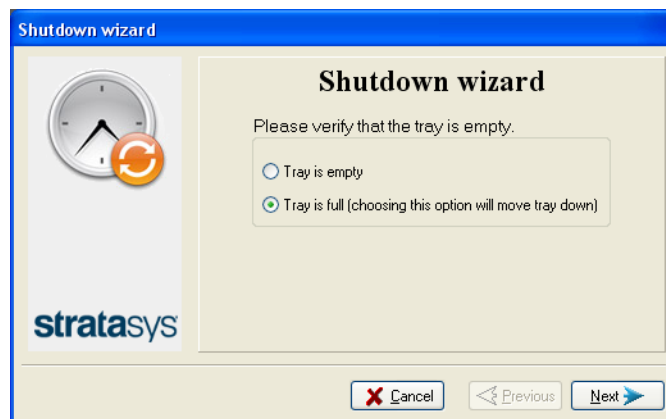

Figure 6-23 Tray status screen

The shutdown procedure begins.

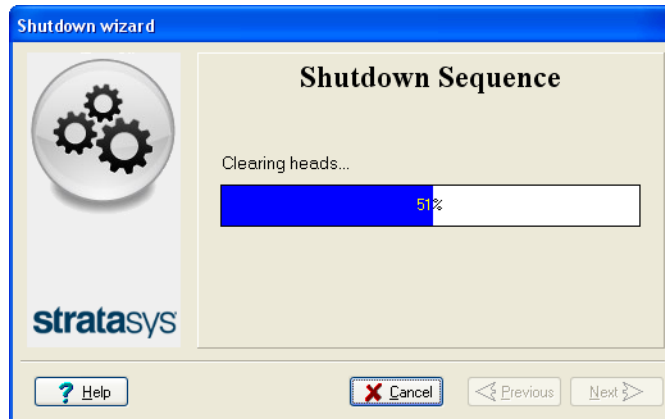

Figure 6-24 Shutdown progress screen

The shutdown procedure may take up to 10 minutes while the following tasks are performed:

- a. The print block returns to its starting point on all axes.
- b. The print heads are heated.
- c. The print heads are cleared of any remaining material.

After these tasks are completed, the final wizard screen appears, in which you choose whether or not to shut down the computer in the Objet printer at this time.

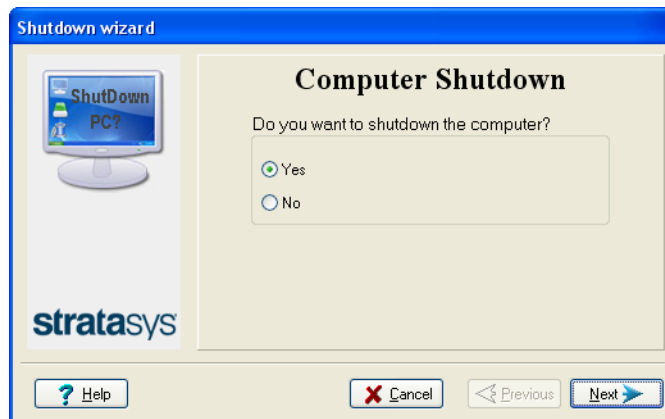

Figure 6-25 Computer Shutdown confirmation screen

5. When completely shutting down the Objet printer and turning the power off, select Yes and click Next.
6. After the printer computer shuts down, turn off the main power switch at the back of the printer (see Figure 6-2 on page 6-3).

## Material Flush/Fill Wizard

Using the Material Flush/Fill wizard before and after an extended period of inactivity (more than one week) ensures proper printer maintenance and quality printing. Each time you run the wizard, you select one of the following processes:

- draining printing materials and flushing the system with cleaning fluid  
Use this process to prepare the printer for a shutdown of more than one week. This process takes about 60 minutes, and requires four (4) cleaning-fluid cartridges in the materials drawer.
- filling the system with fresh printing materials  
Use this process to restore the printer to working condition. This process takes about 30 minutes, and requires two (2) cartridges of Model material and two (2) cartridges of Support material in the materials drawer.



After more than one week of inactivity, drain and flush the system if this was not previously done. In this case, run the wizard twice before printing—first, to drain old printing material and clean the system, and again, to fill it with fresh material.

To run the Material Flush/Fill wizard:

1. Start Material Flush/Fill wizard from the *Options* menu.
2. In the opening screen, click Next.

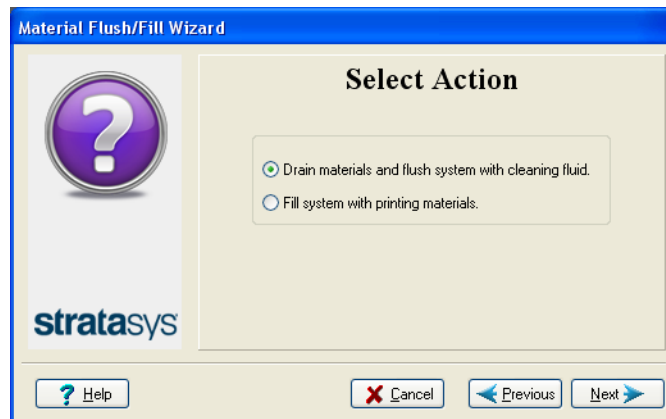

Figure 6-26 Wizard procedure selection

3. Select the required procedure, and click Next.

**Note:** Before continuing, make sure the required cartridges of material are available for the procedure selected.

4. Load the required cartridges, close the drawer, and confirm this in the wizard screen.

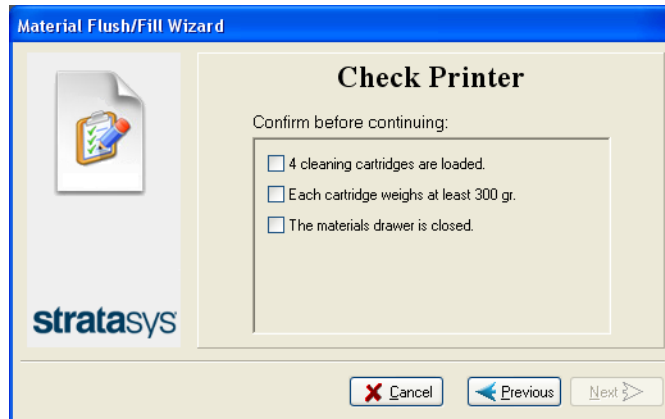

Figure 6-27 Cartridge confirmation screen—before flushing

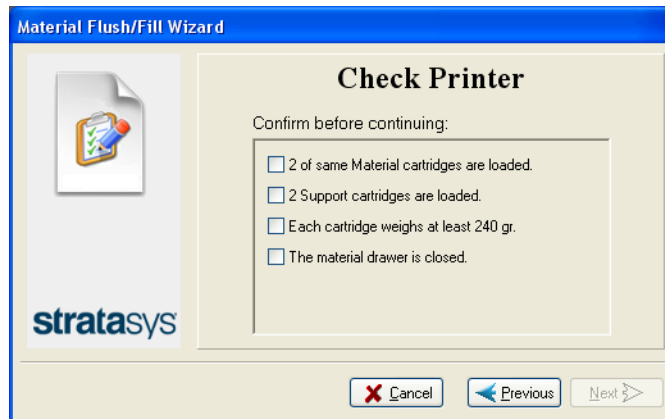

Figure 6-28 Cartridge confirmation screen—before filling

5. In the next wizard screen, confirm that the printer cover is closed, and click Next.

The wizard runs the material-flushing cycles.

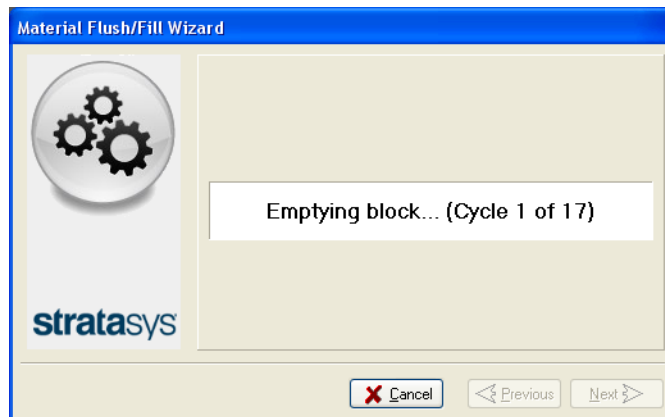

Figure 6-29 Flushing cycles in progress

6. If cleaning-fluid cartridges are loaded in the printer, the wizard prompts you to remove them. Confirm this in the wizard screen, and click Next.



Figure 6-30 Final wizard screen



After preparing the printer for an extended shutdown period with this wizard, you should close the printer-control application and Windows, and then turn off the printer.

## Maintaining the Printer

Performing routine maintenance tasks is essential for getting satisfactory results from Objet30 3D printers. Perform the tasks at specified intervals.



When switching the printer to online mode, a message is displayed if a maintenance activity is required to ensure optimum printing quality. Maintenance notifications can be disabled/enabled from the *Options* menu.

### Routine Maintenance Schedule

Frequency	Task	For More Information
After every print job	Clean the print heads and the roller surface.	See "Cleaning the Print Heads and the Roller" on the next page.
Weekly	Perform the Pattern test.	See "Pattern Test" on page 6-33.
Weekly	Clean and inspect the wiper.	See "Cleaning and Replacing the Wiper" on page 6-31.
Weekly— <i>when printing with MED610</i>	Calibrate the UV intensity.	See "Testing and Calibrating the UV Lamp" on page 6-62.
Weekly	Restart the printer computer and the server computer.	
Every 300 hours of printing (A reminder message appears.)	Calibrate the UV intensity.	See "Testing and Calibrating the UV Lamp" on page 6-62.
Every 300 hours of printing	Optimize the print heads.	See "Optimizing (Calibrating) Print Heads" on page 6-43.
Monthly, and after replacing print heads	Check the alignment of the print heads.	See "Aligning the Print Heads" on page 6-39.
Every 500 hours of printing, or once every six months	Calibrate the load cells.	See "Calibrating the Load Cells" on page 6-65.



Frequency	Task	For More Information
Every 1000 hours of printing, or once a year	Preventive maintenance.	See "Preventive Maintenance Tasks" on page 6-98.
Once a year	Inspect the activated-carbon odor filter, and replace if necessary.	See "Replacing the Odor Filter" on page 6-67.
Once in two years	Calibrate the UV sensor	Performed by a Stratasys Service Engineer.

### Cleaning the Print Heads and the Roller

Periodic inspection and cleaning of the orifice plates on the bottom of the print block ensures that the print nozzles are not clogged. A wizard guides you through the procedure, and adjusts components of the printer to enable you to perform it. To maintain the Objet30 printer in optimum condition, clean the print heads after every print job, when you remove the model from the build tray. This procedure takes about 20 minutes.

To clean the print heads and the roller:

1. Prepare—
  - isopropanol (IPA—*isopropyl alcohol*) or ethanol (*ethyl alcohol*)
  - disposable cleaning gloves
  - a supplied cleaning cloth or equivalent
  - a mirror
2. Start the Head Cleaning wizard from the *Options* menu (see Figure 6-35 on page 6-31).
3. Follow the instructions on the wizard screens, and select the confirmation check boxes.

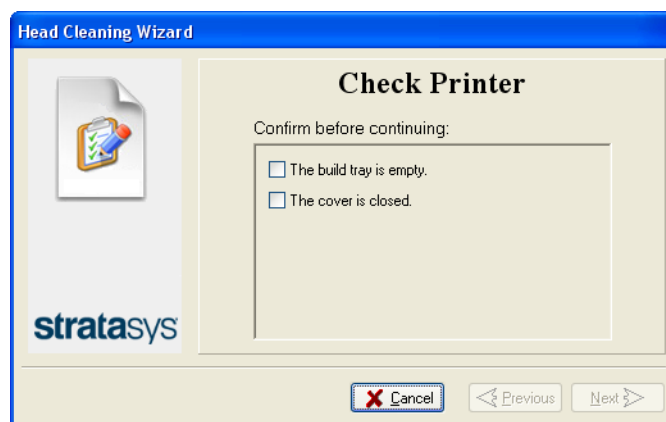

Figure 6-31 Head cleaning procedure—wizard screen

4. Click **Next**.  
The printer prepares for you to clean the print heads.
5. When the following screen appears, open the cover.

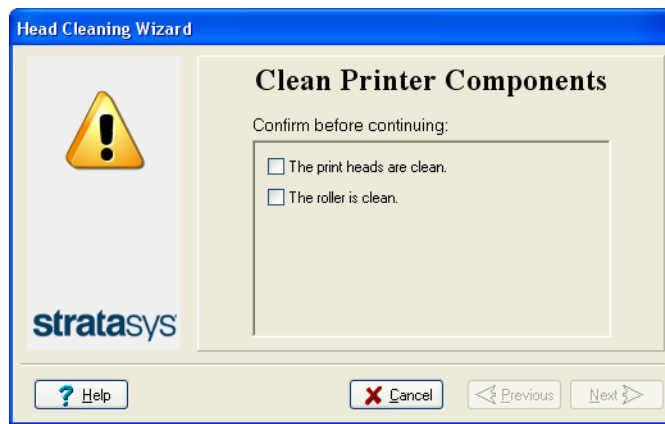

Figure 6-32 Head cleaning wizard—steps 5–11

**Warning: Hot Surface**

The print head orifice plates (bottom surface) may be hot. Do not touch them with your bare hands, and proceed with caution.

6. Place the mirror on the build tray.
7. Put on the gloves.

**Caution**

Uncured printing material on the print heads might cause skin irritation. Use disposable cleaning gloves to protect your hands.

8. Soak the cleaning cloth with alcohol.
9. Clean the orifice plates, with a back-and-forth motion (see Figure 6-33). Use the mirror to make sure that you have removed all of the residue material.

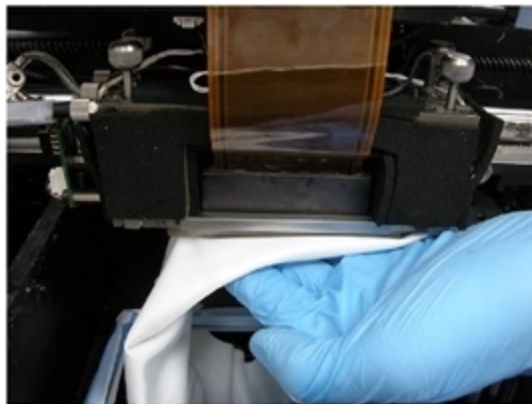

Figure 6-33 Cleaning the heads

10. Clean the entire roller surface, by rotating it as you clean.



Use this opportunity to clean the glass lens on the UV lamp.

11. When you have finished cleaning, select the confirmation check boxes in the wizard screen (see Figure 6-32) and click **Next**.
12. Remove the cleaning materials from the printer and close the cover.
13. Select the confirmation check boxes in the wizard screen and click **Next**.  
The head-purge cycle begins. When this is complete, the final wizard screen appears.



Figure 6-34 Head-cleaning wizard—final screen

14. Click **Done** to close the wizard.

## Cleaning and Replacing the Wiper

A rubber wiper removes excess material from the print heads after the purge sequence. This is done automatically before each print job, and performed manually during maintenance tasks. You should clean the wiper and surrounding area daily. If the wiper is damaged or worn, replace it.

To inspect and clean the wiper:

1. Prepare—
  - isopropanol (IPA—*isopropyl alcohol*) or ethanol (*ethyl alcohol*)
  - disposable cleaning gloves
  - a supplied cleaning cloth or equivalent
  - a spare wiper
  - an M2.5 hex (Allen®) key
2. Start the Wiper Cleaning wizard from the *Options* menu.

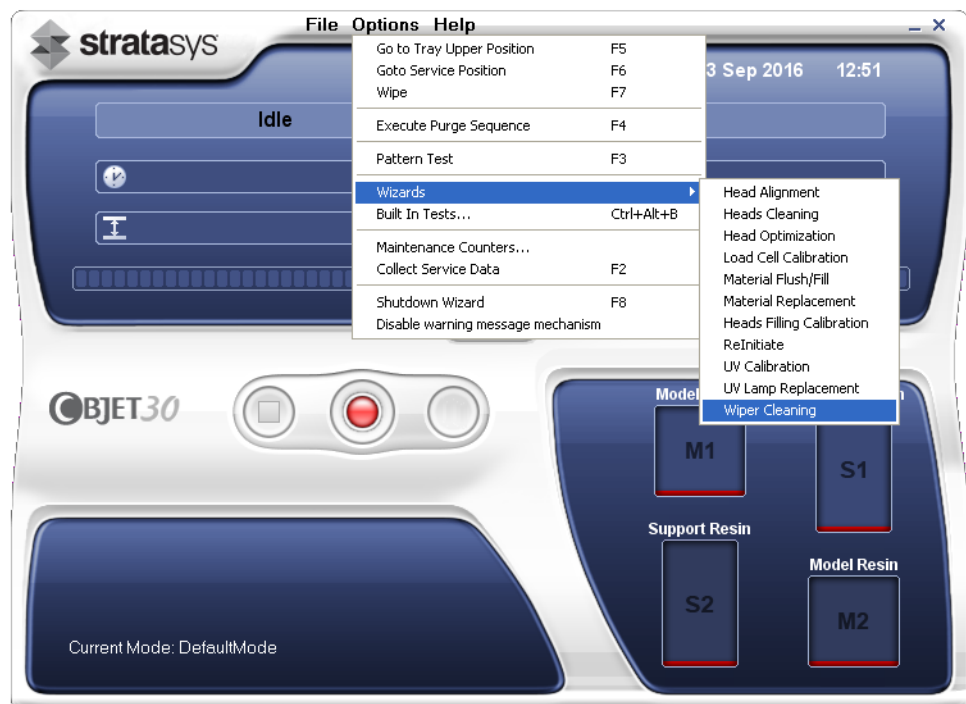

Figure 6-35 Starting the Wiper Cleaning wizard

3. In the opening wizard screen, click Next.

4. Make sure that the build tray is empty, and close the printer cover. Confirm this in the wizard screen and click Next.

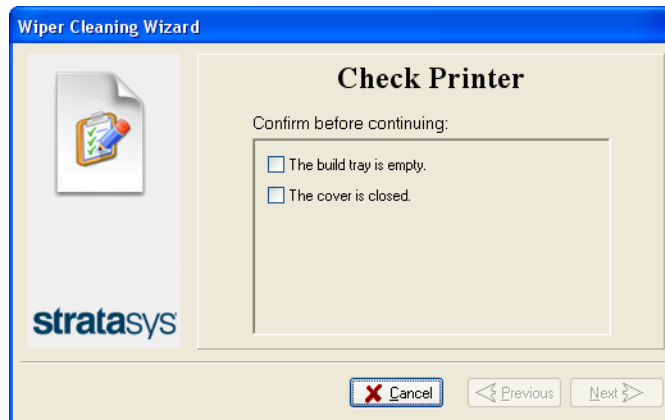

Figure 6-36 Wiper Cleaning —step 4

5. When the following screen appears, open the cover.

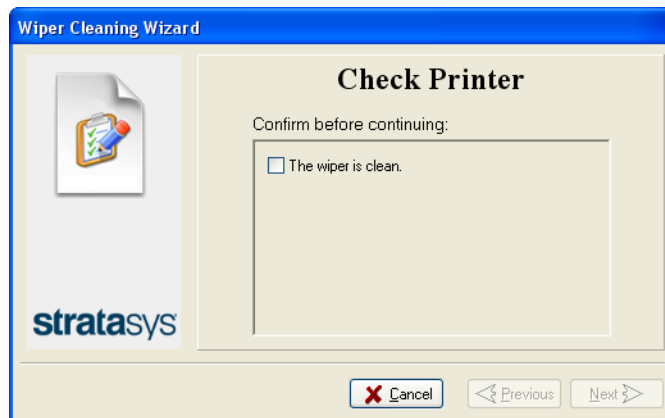

Figure 6-37 Wiper Cleaning wizard during steps 6–9

6. Put on the cleaning gloves.
7. Using a generous amount of alcohol on the cleaning cloth, remove any material remaining on the wiper and the surrounding area.
8. Inspect the wiper.

If the wiper is scratched, torn or worn, or if you cannot clean it completely, replace it.

- a. With the M3 hex (Allen) key, loosen (**but do not remove**) the screw securing the wiper.



Figure 6-38 Wiper and excess-material drain

- b. Grasp the wiper unit and remove it.
  - Note:** Do not remove the grease.
- c. Insert the new wiper, making sure that it is level, and tighten the securing screw.
9. In the wizard screen (see Figure 6-37), confirm that the wiper blade is clean, and click Next.
10. Remove all tools and cleaning materials from the printer, and close the cover.
11. Confirm this in the wizard screen, and click Next.

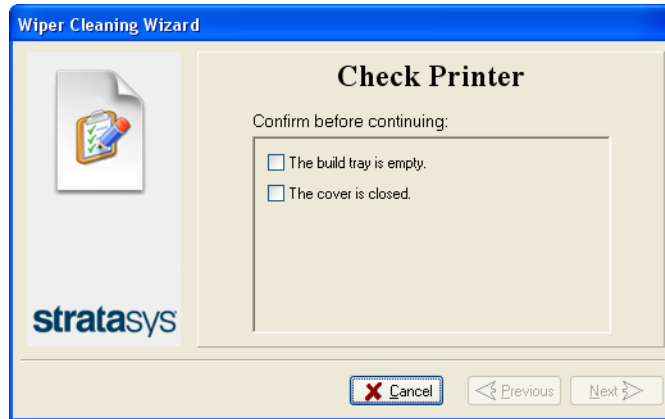

Figure 6-39 Confirmation screen

12. Click Done to close the wizard.

## Pattern Test

The pattern test is the basic verification of the printer's ability to produce quality models, since it demonstrates the condition of the nozzles in the print heads. Make sure, therefore, that you perform this test weekly, and whenever you suspect a printing problem.

To perform the pattern test:

1. Make sure that the build tray is empty.
2. Prepare a sheet of pink paper, approximately 21 × 14 centimeters in size (8.5 × 5.5 inches)—half of the standard A-4 or Letter size.
3. In the printer, tape the pink paper to the center of the build tray.
4. Press F3, or open the *Options* menu and select **Pattern Test**.

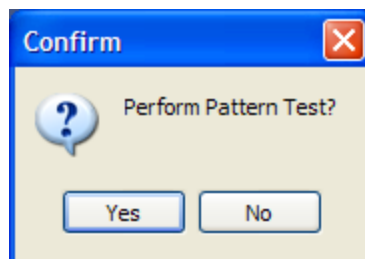

Figure 6-40 Pattern Test confirmation

5. In the following dialog box, click OK to confirm that the paper is in place on the build tray.

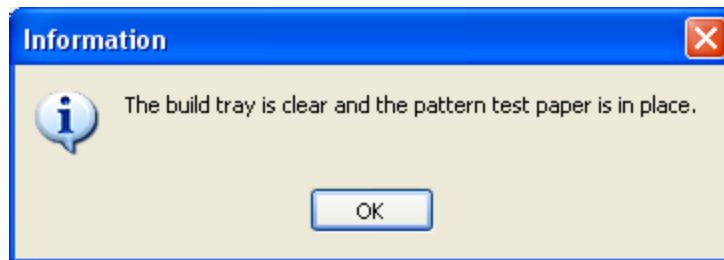

Figure 6-41 Confirmation before printing on test paper

The printer prints a series of lines on the test paper (see next figure).

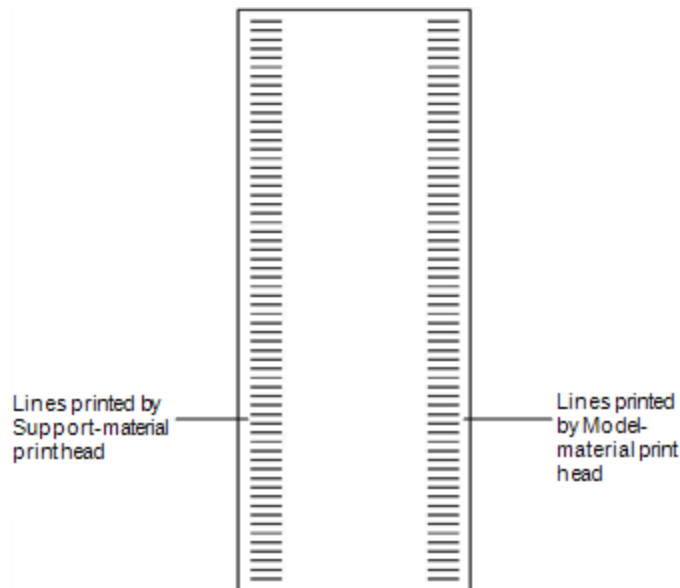

Figure 6-42 Sample Pattern Test

6. Carefully inspect the test paper to see if there are missing lines.  
Too many missing lines, especially if they are in the same area, indicates that the quality of printing when producing models will be poor. If this is the case, see "Improving Print Quality" on the next page.

**Note:** Acceptable model quality is subjective, and depends on the type and scale (size) of the models produced. As a rule, however, more than 10 missing lines in one area of a column is considered unacceptable. As a rule, however, if two consecutive lines are missing, or if there are more than 10 lines missing in either column, the model quality is usually unacceptable.

## Improving Print Quality

If you suspect that print quality is poor, perform the pattern test (see "Pattern Test"). If the results are poor, use the following procedure to improve print quality.

If the results of the last pattern test are poor:

1. From the *Options* menu, select *Purge Sequence*, or press F4.
2. In the confirmation dialog box, click **Yes**.  
The print heads are purged of Model and Support material, and the wiper removes excess material from them.
3. Repeat the purge sequence.
4. Perform the pattern test.

If the results of the pattern test are still poor:

1. Manually clean the print heads (see "Cleaning the Print Heads and the Roller" on page 6-28).
2. Perform the purge sequence.
3. Perform the pattern test.

If the results of the pattern test are still poor:

1. Carefully clean the print heads again, making sure there is no residue left on them.
2. Perform the purge sequence.
3. Perform the pattern test.

If the results of the pattern test are still poor:

- Optimize the print heads and replace faulty print heads, if necessary (see *Optimizing (Calibrating) Print Heads*).



## Cleaning and Replacing the Roller Waste Collector

Normally, you do not have to inspect and clean the roller waste collector. This is done by a customer-support engineer during regular maintenance visits. Occasionally, however, a blockage or damaged scraper may cause material leakage on the build tray. If this happens, remove the roller waste collector to inspect it.

To remove the roller waste collector:

1. Start the Head Cleaning wizard from the *Options* menu (see on page 6-31).  
This wizard prepares the printer for removing the roller waste collector.
2. When the following screen appears, confirm that the tray is empty and that the printer cover is closed, then click **Next**.

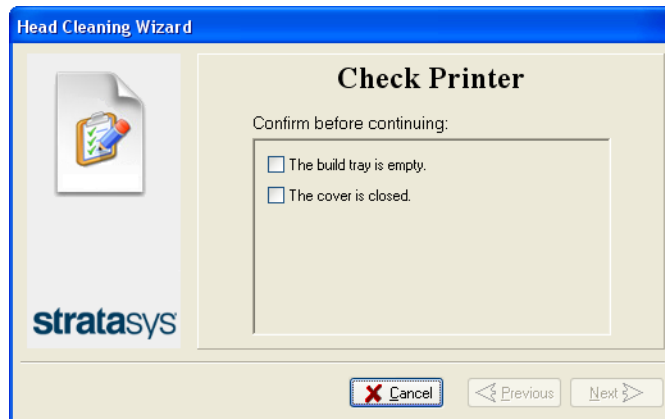

Figure 6-43 Wizard confirmation screen

The print block moves to the center of build tray, and the tray lowers.

3. When the following screen appears, open the cover.

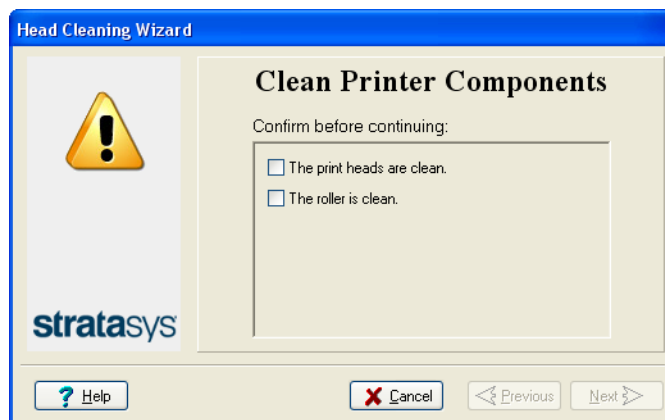

Figure 6-44 Wizard screen that appears when you can begin the procedure



### Warning: Hot Surface

The print head orifice plates (bottom surface) may be hot. Do not touch them with your bare hands, and proceed with caution.

4. Put on protective gloves.

5. Loosen the two side screws securing the UV lamp assembly, and place the assembly on top of the print block.



Figure 6-45 UV-lamp-assembly securing screws

6. Pull out the drain-tube release mechanism to raise the tubes out of the waste collector (see figure below).

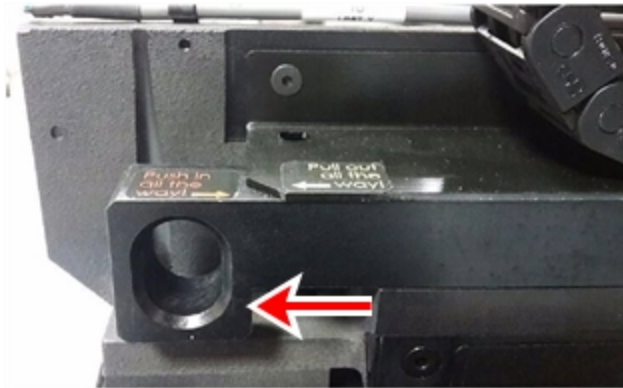

Figure 6-46 Freeing the drain tubes from the waste collector

**Important:** Pull out the release mechanism *completely*.

7. Support the roller waste collector with your hand under it, and use a 3 mm hex (Allen) key to loosen the screws.



Figure 6-47 Roller-waste-collector screws

8. Pull out the roller waste collector, taking care not to touch or damage the scraper.



### Warning

The scraper is very sharp! Proceed with caution.



Figure 6-48 Roller waste collector

9. Inspect the roller waste collector.
  - If the scraper is damaged, replace the entire roller-waste-collector unit.
  - If the scraper is not damaged, carefully remove any waste from the waste channel, taking care not to damage the scraper. If necessary, use IPA or ethanol to dissolve residue material in the waste channel and on the scraper.

**Note:** The waste collected in this unit contains uncured resin. Dispose of it in accordance with applicable environmental regulations.

To install the roller waste collector:

1. Carefully insert the roller-waste-collector unit.
2. Secure the unit evenly, by alternately tightening the screws.
3. Return the drain-tube release mechanism to its original position by pushing it in all the way.

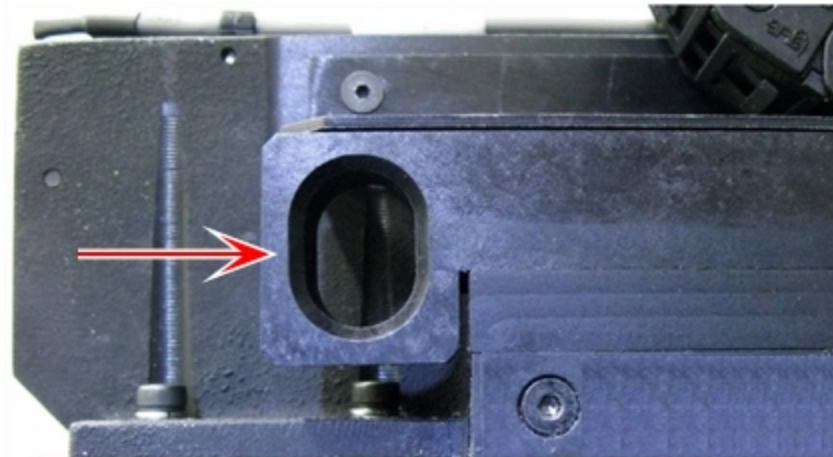

Figure 6-49 Returning the drain tubes from to the waste collector

4. Move the print block back to the middle of the printer.

5. Replace the UV lamp assembly in the printer, making sure that the cable fits into the slot together with the side securing screw.



Figure 6-50 UV-lamp cable in place after securing the assembly

6. Remove all tools from the printer, and close the cover.
7. In the wizard screen, click Cancel to return the build tray to its former position.

## Aligning the Print Heads

You should check the alignment of the print heads—

- once a month
- after replacing one or more heads
- if model quality is not acceptable even after cleaning the orifice plate on the bottom of the print block (see "Cleaning the Print Heads and the Roller" on page 6-28).

This procedure takes about 20 minutes.

To check the alignment of the print heads:

1. Prepare—
  - a transparency sheet, at least 10.5 × 13 centimeters in size (4.5 × 5.5 inches)—about one-quarter of the standard A-4 or Letter size
  - any type of adhesive tape, to fasten the transparency sheet to the build tray
2. Start the Head Alignment wizard from the *Options* menu.
3. Click Next to begin, and close the cover.

4. In the wizard screen, select the check box to confirm that the cover is closed, and click Next.

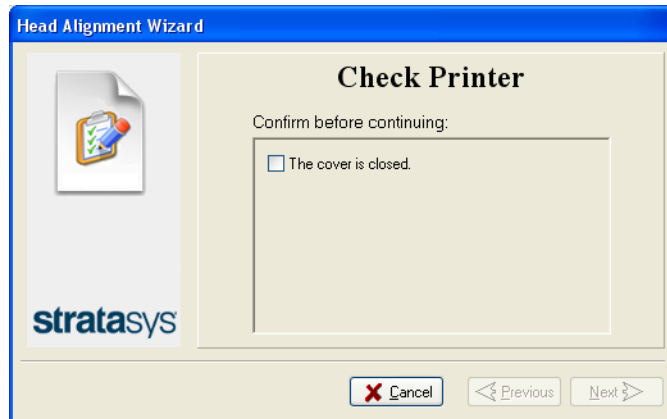

Figure 6-51 *Door is closed* confirmation screen

5. When instructed to do so, place the transparency on the build tray— near the left and rear edges of the tray, as shown in the following figure.

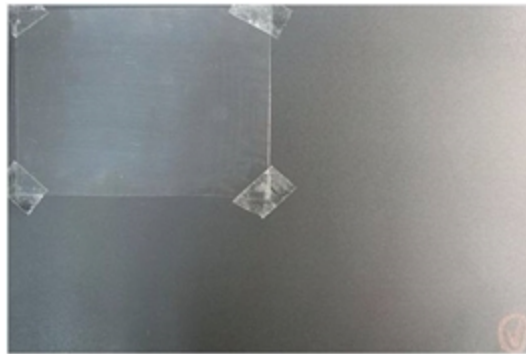

Figure 6-52 Positioning the transparency on the build tray

6. Make sure that the transparency sheet is lying flat, and tape it to the tray.
7. In the wizard screen, select the check box to confirm that the transparency sheet is on the build tray, and click Next.  
The printer prints the head alignment test on the transparency.
8. When the following screen appears, remove the transparency.

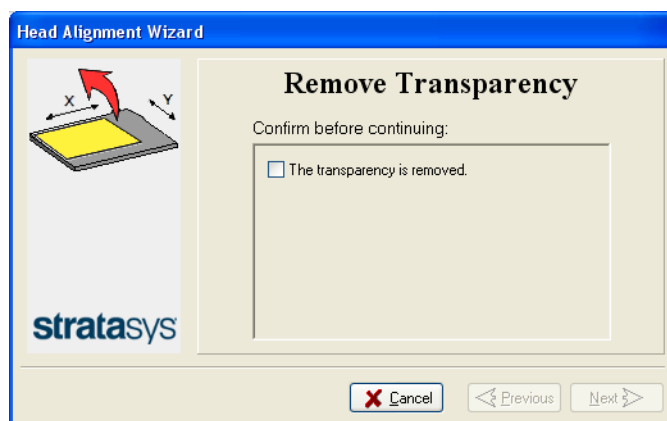

Figure 6-53 Head Alignment wizard—steps 8–10

The transparency sheet is printed with sets of vertical lines in two rows, each showing the results from a different print head.



Figure 6-54 Sample head-alignment test

- The top row was printed by the head used for applying Model material when producing models. From right to left, the columns represent heads M1, M2, M3, respectively. (There is no column for head M0 because its alignment is used as a reference for aligning all other heads.)
  - The bottom row was printed by the head used for applying Support material.
9. Use a magnifying glass or loupe to inspect the transparency. Optimum head alignment is shown when the two #8 lines, in the upper and lower rows, are aligned, as in Figure 6-54. In the example shown, no change to the head alignment is necessary. If other lines in the set are aligned, you need to change the alignment—in the next wizard screen.
  10. In the wizard screen shown in Figure 6-53, select the *Transparency removed* check box, and click Next.

The first in a series of alignment screens appears.

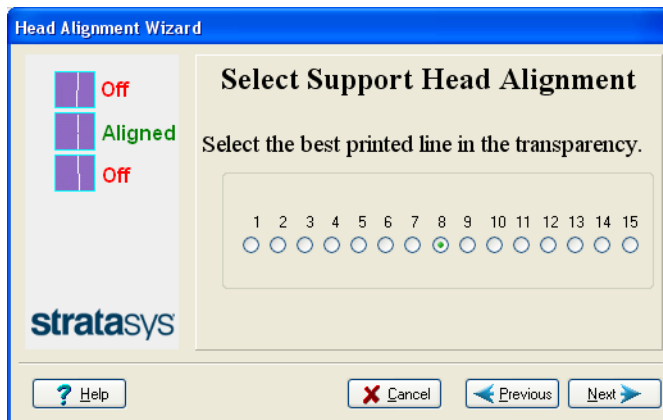

Figure 6-55 Head alignment screen

11. In the head-alignment screen, select the number that indicates which lines align in the upper and lower rows.

**Note:** Because the alignment of the middle lines is optimum, the number “8” is selected, by default, in the wizard screen. This does not change the head alignment. If you select other numbers, the wizard adjusts the head alignment, accordingly.

12. Click Next.

The following screen is displayed.



Figure 6-56 Parameter update confirmation

13. Continue as follows:

- To make the alignment changes in the printer, make sure that *Yes* is selected, and click *Next*.
- To recheck the alignment test results before making the alignment changes in the printer, click *Previous*.
- If you do not want to make alignment changes in the printer at this time, select *No* and click *Next*.

14. In the following screen, you can choose to either repeat the head alignment procedure or close the wizard.

- If the most closely aligned vertical lines for a print head were at either extreme, choose *Repeat the test*, then click *Next*.  
The transparency test will show if the heads are now properly aligned, and—if not—the wizard will allow you to “fine tune” the alignment.
- If the vertical lines for the print heads were not aligned at either extreme, choose *End the wizard*, then click *Next*.



Figure 6-57 Repeat head alignment option



If the Head Alignment wizard was opened from the Head Optimization wizard after replacing print heads, the printer application closes and re-opens when you click *Done* in the final wizard screen.

## Optimizing (Calibrating) Print Heads

The condition of the print heads directly affects the quality of printed models. To maintain optimum printing, test the print heads, and calibrate them to the best working configuration possible by running the Head Optimization wizard. This procedure takes about one hour to complete.

If, during the optimization process, the wizard determines that a print head is faulty—or that it is negatively affecting layer uniformity with the current head configuration—the wizard instructs you to replace it. If this happens, you can continue the wizard to replace the print head, or abort the wizard, to replace the head at another time. This procedure takes about 2.5 hours more to complete.



Run the Head Optimization wizard every 300 hours of printing or whenever the condition of print heads is negatively affecting the quality of printed models, or if you suspect that there is a problem with one or more of the print heads.

To test and calibrate the print heads:

1. Prepare—
  - isopropanol (IPA—*isopropyl alcohol*) or ethanol (*ethyl alcohol*)
  - disposable cleaning gloves (any clean, powder-free protective gloves)
  - the supplied cleaning cloth or equivalent
  - a mirror
  - the Missing Nozzles ruler
  - the scale supplied for use in the Weight Test

Ensure that the scale is calibrated and charged before beginning this procedure.

2. Make sure that the type of material loaded in the printer is *not* Tango™ (flexible material).
3. Start the Head Optimization wizard from the *Options* menu.

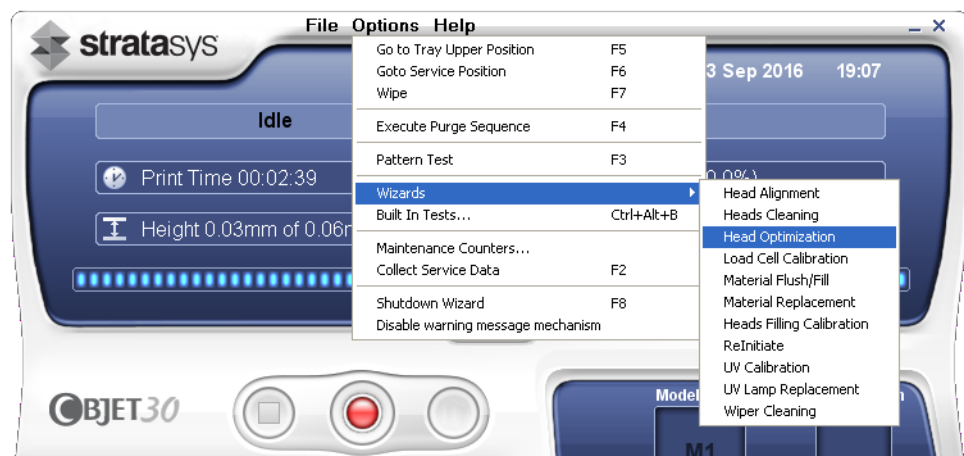

Figure 6-58 Starting the Head Optimization wizard

4. In the opening wizard screen, click Next to begin.
5. Close the printer cover, and confirm this in the wizard screen.



- In the following screen, make sure *Optimize all print heads* is selected, and click **Next**.

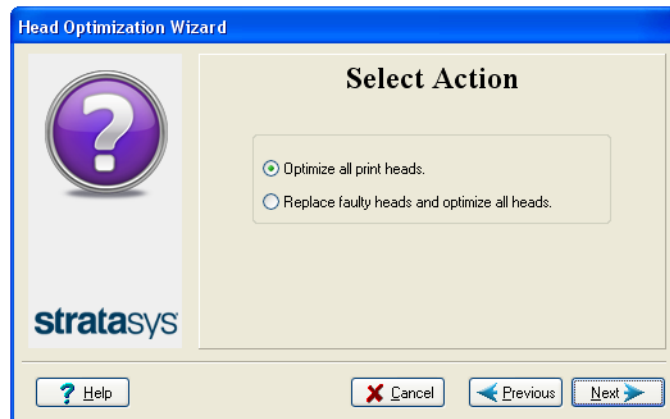

Figure 6-59 Procedure selection screen

The print block moves into position for cleaning and inspecting the print heads.

- When the following screen appears, clean the print heads.

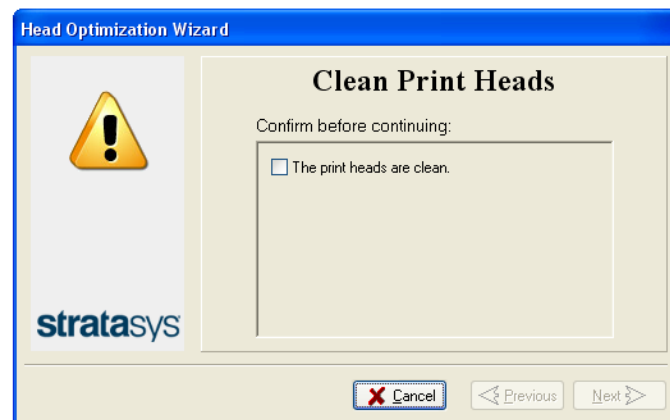

Figure 6-60 Clean print heads screen



### Warning: Hot Surface

The print head orifice plates (bottom surface) may be hot. Do not touch them with your bare hands, and proceed with caution.

- Place the mirror on the build tray.
- Put on the cleaning gloves.
- Soak the cleaning cloth with alcohol.

11. Clean the orifice plates, with a back-and-forth motion.  
Use the mirror to make sure that you have removed all of the residue material.

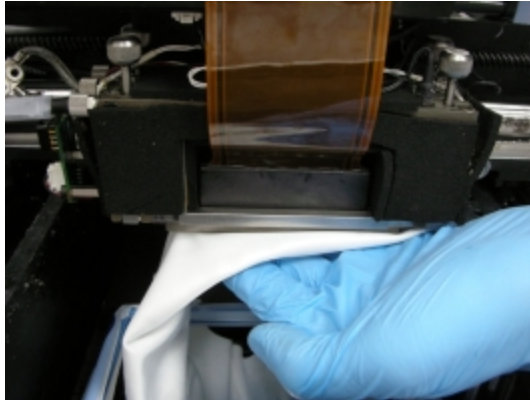

Figure 6-61 Cleaning the print heads

12. When the print heads are clean, select the confirmation check box in the wizard screen and click Next.
13. Remove the cleaning materials and the mirror from the printer, and close the cover.
14. Confirm the items listed in the next screen, and click Next.

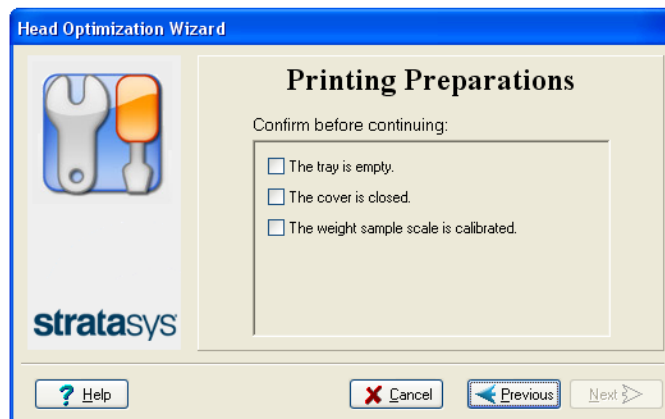

Figure 6-62 Confirmation screen



Make sure that the scale for weighing the printed samples is calibrated. Inaccurate readings may result in print heads that are not optimized for quality printing, or a false indication that a head needs to be replaced.

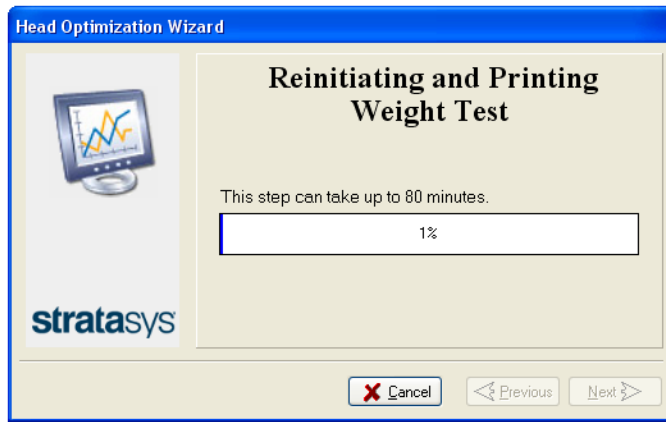

Figure 6-63 Printing Weight Test

The printer prepares itself for printing (by running the reinitiate process). Then, 6 or 12 samples are printed on the build tray, depending on the printer model. This can take up to 80 minutes.

15. When the following screen appears, open the printer cover to inspect the printed samples.

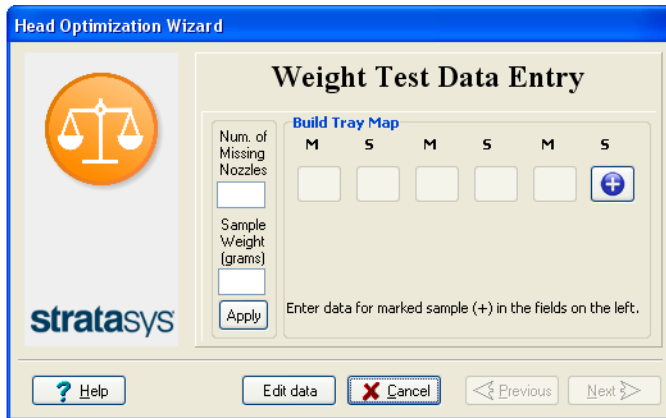

Figure 6-64 Data-entry screen (some Objet30 printers)

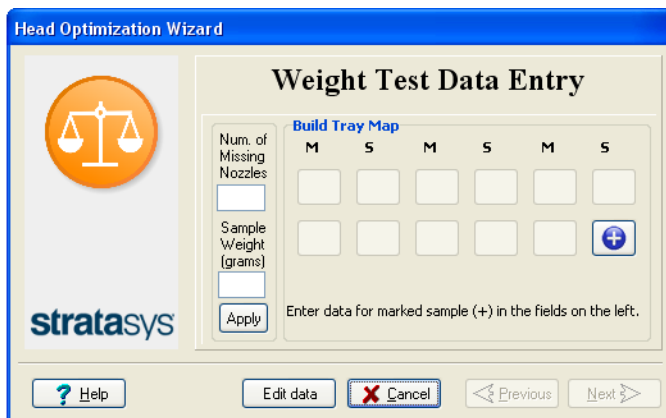



Figure 6-65 Data-entry screen (some Objet30 printers)



The layout of the data entry screen matches the printed samples on the build tray. You enter the data for the sample indicated by  in the screen.

16. Using the Missing Nozzles ruler, determine the number of clogged (“missing”) nozzles.

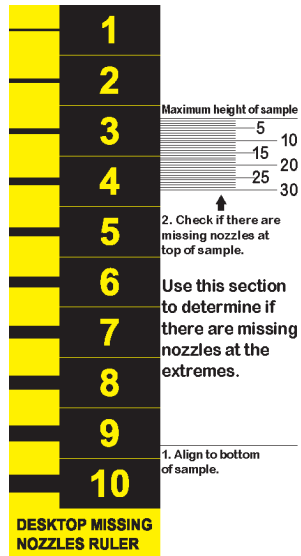

Figure 6-66 Missing Nozzles ruler

Clogged nozzles are seen in Weight Test samples as missing rows of printed material.

- a. Place the alignment line on the right side of the ruler next to the bottom of the sample, as shown.

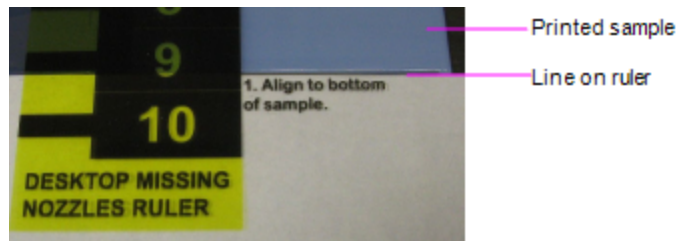

Figure 6-67 Aligning the ruler to the bottom of the sample

- b. Check if there is a space below the line on the ruler marked “Maximum height of sample.”

A space below this line indicates missing nozzles at the extremes of the printed sample. The numbers indicate how many printed rows (nozzles) are missing. Remember this number.

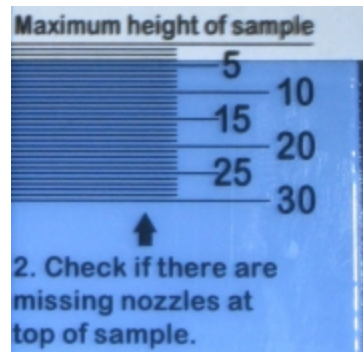

Figure 6-68 Measuring missing nozzles at the extremes of the sample

**Note:** Because you align the ruler to the bottom of the printed sample, missing nozzles at the bottom edge are measured at the top of the ruler.

- c. Check if there are gaps in the printed sample by matching the gap in the sample with a line on the Missing Nozzles ruler. The number on the ruler next to the line indicates the number of missing rows/nozzles.

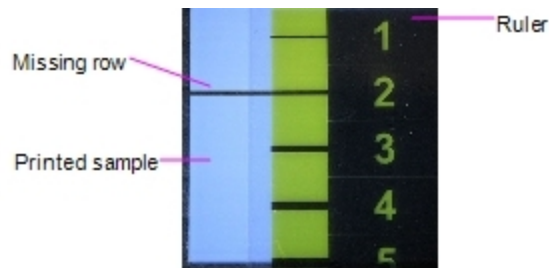



Figure 6-69 Measuring a missing row in a printed sample  
In the example above, the number of missing nozzles is two (2).

- d. Enter the total number of missing rows in the wizard screen (in the “missing nozzles” field).

**Note:** During this procedure, the roller does not smooth the surface of the printed samples. Do not mistake the visible lines in the sample for missing material.



Figure 6-70 Printed sample for Head Optimization

17. Carefully remove the sample, weigh it, and enter the weight in the wizard screen.  
Be sure to remove and weigh the entire sample, even if it breaks into several pieces.
18. After entering the number of missing nozzles and the weight of the sample, click Apply or press Enter.  
The data-entry-indicator  moves to the next position.
19. Enter the data for all printed samples.



To change an entry, click **Edit Data**, enter the correct data, and click **Save**.

20. When you have entered the data for all printed samples, click **Next**.

The wizard uses the data collected to analyze the condition of the print heads, and optimizes them so they print models with a uniform layer of material.

- If the heads are in satisfactory condition, the following wizard screen appears.<sup>1</sup>

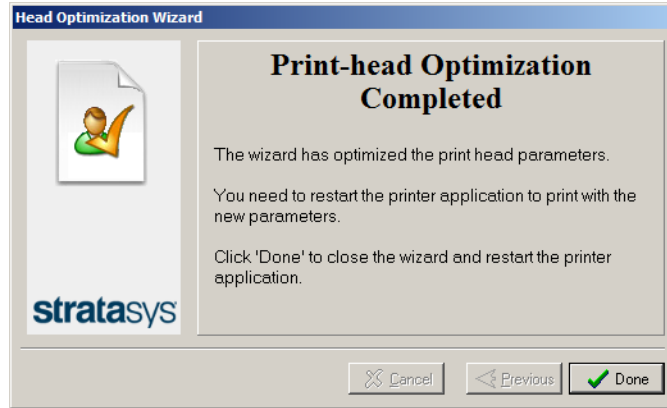

Figure 6-71 Final wizard screen, after optimizing print heads

**Note:** To apply the optimized settings to the print heads, the printer application must be restarted. When you click **Done**, the application closes and re-opens.

- If the wizard determines that a print head is faulty—or that it is negatively affecting model quality with the current head configuration—the wizard instructs you to replace it. In this case, the following screen appears.

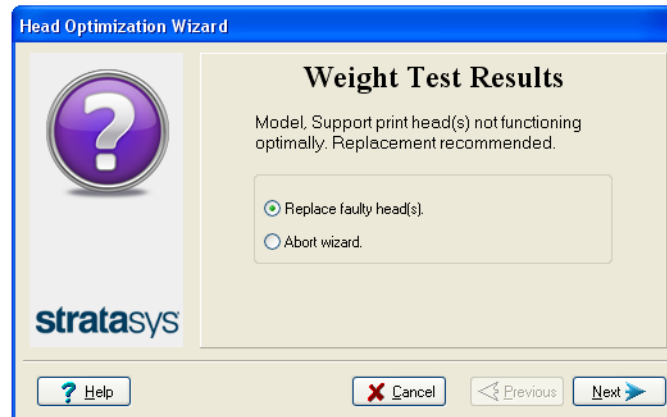

Figure 6-72 Defective print heads found

<sup>1</sup>However, after optimizing print heads following their replacement, a screen appears enabling you to continue by running the Head Alignment wizard (see page 35). This is necessary before printing models.

If you choose *not* to align the heads at this time, the printer application closes and re-opens when you click **Done**.

21. Choose *Replace faulty head(s)* if you are prepared to replace the print heads now.  
or—  
Choose *Abort wizard* if you want to replace the print heads at another time.



Replace print heads only after consulting with a Stratasys-authorized customer-support engineer.

To replace print heads, you need these tools and materials:

- replacement print head(s)
- isopropanol (IPA—*isopropyl alcohol*) or ethanol (*ethyl alcohol*)
- disposable cleaning gloves (supplied with the print head; or use any clean, powder-free protective gloves)
- a supplied cleaning cloth or equivalent
- the scale supplied for use in the Head Optimization wizard (Weight Test)
- the Missing Nozzles ruler

If you are replacing print heads now, the wizard guides you through the procedure when you click *Next*. Continue with "Preparing the Print Block" on page 6-53.

## Replacing Print Heads

The condition of the print heads directly affects the quality of printed models. You may need to replace a print head if one or more of the following symptoms occurs:

- The Head Optimization wizard determines that a print head is defective. (See "Optimizing (Calibrating) Print Heads" on page 6-43.)
- There are noticeable grooves in the surface of printed models.
- Visual inspection of the head reveals that its surface is damaged—peeling or bubbles in the nozzle area.
- The printer interface displays a warning or malfunction message relating to a print head—
  - Head Heater temperature timeout
  - Head Heater thermistor open
  - Head Heater thermistor short



Replace print heads only after consulting with an authorized customer-support engineer.



The Head Optimization wizard guides you through the procedure of replacing a print head, and adjusts printer components to enable you to perform it. Only replace a print head with the aid of the wizard. The entire procedure takes about 2.5 hours, and consists of the following phases:

A. Identifying the head(s) needing replacement.

This is normally done by the Head Optimization wizard. Otherwise, evidence of physical damage to the head surface or a malfunction message indicates which head needs replacing.

B. Preparing the print block for head replacement.

This is done automatically when you run the wizard.

C. Removing the defective print head.

D. Installing a new print head.

E. Optimizing the print heads (done automatically by the wizard).

F. Performing head alignment.

To replace a print head:

1. Prepare—

- replacement print head(s)
- isopropanol (IPA—*isopropyl alcohol*) or ethanol (*ethyl alcohol*)
- disposable cleaning gloves (supplied with the print head; or use any clean, powder-free protective gloves)
- a supplied cleaning cloth or equivalent
- the scale supplied for use in the Head Optimization wizard (*Weight Test*)
- the *Missing Nozzles* ruler

**Note:** Make sure that you have these items and that the scale is calibrated and charged before performing the head-replacement procedure.

2. Start the Head Optimization wizard from the *Options* menu (see figure 6-38 on page 29).
3. In the opening wizard screen, click *Next* to begin.
4. In the following screen, select *Replace faulty heads*, and click *Next*.

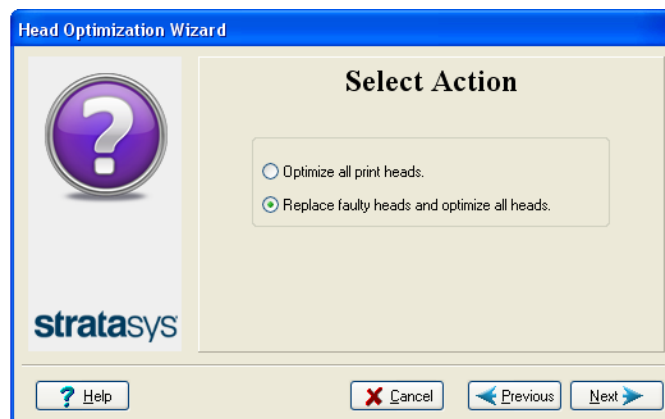

Figure 6-73 Procedure selection screen

Preparing the Print Block

5. Select the print head(s) needing replacement, and click Next.

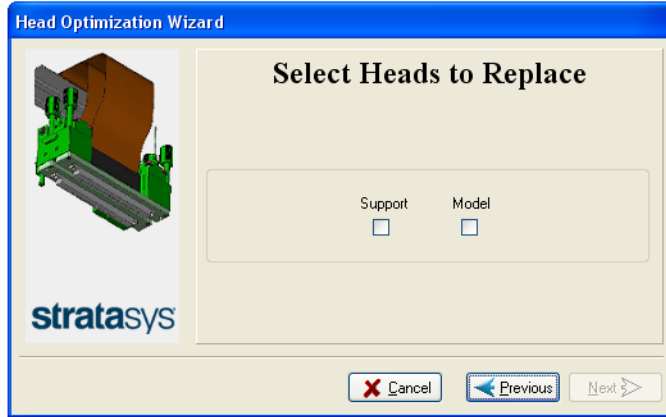

Figure 6-74 Head selection screen

The printer heats and empties the print block, and prepares the printer.

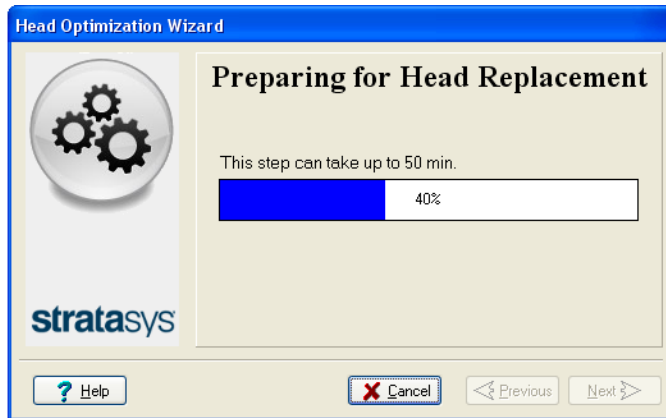

Figure 6-75 Printer preparation progress screen

6. The following screen appears when the printer is ready for you to replace print heads.

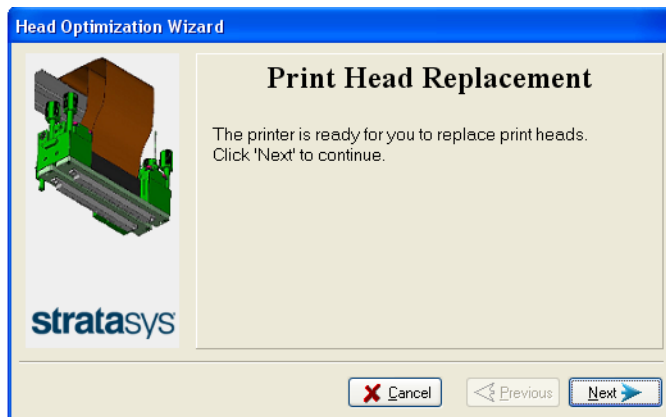

Figure 6-76 Printer ready for head replacement

- Put on the protective gloves and open the printer cover.

**Note:** The printer disconnects power to the heads for your safety.

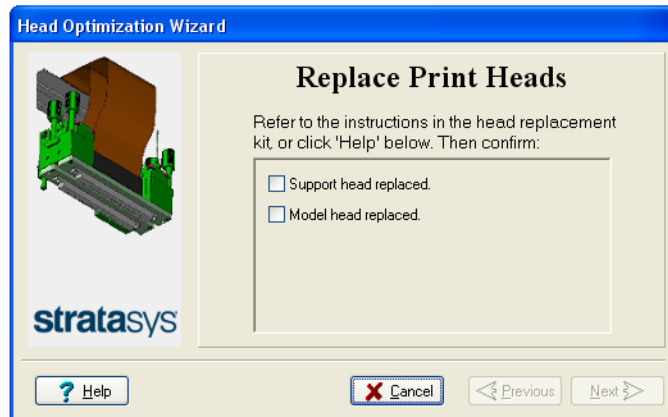

Figure 6-77 Print-head replacement confirmation

### Removing the Defective Head



To replace the Model print head, you must first remove the Support print head.

### Removing the Support Print Head

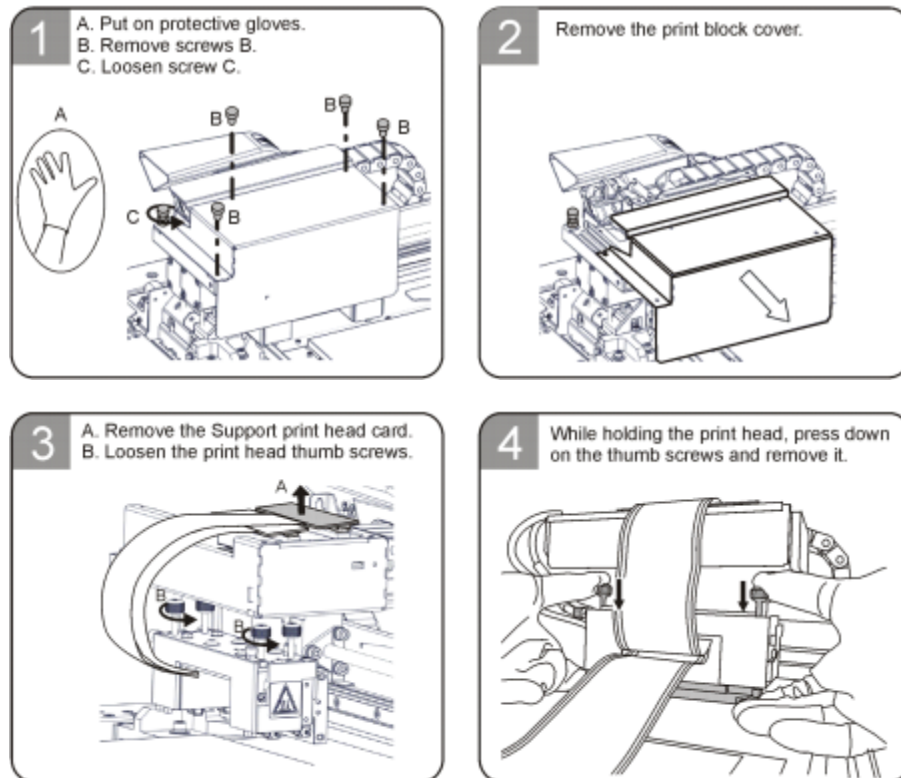

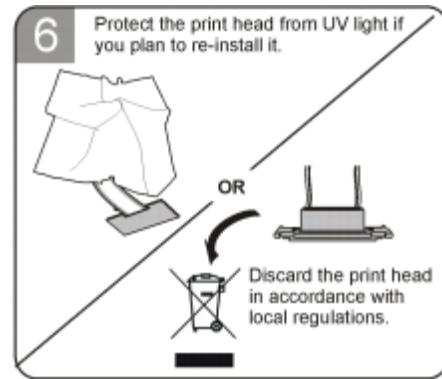
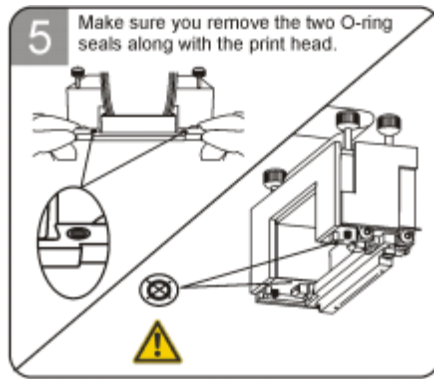

➤ **If you do not need to replace the Model print head, continue with "Removing the Defective Head" on the previous page.**

### Removing the Model Print Head

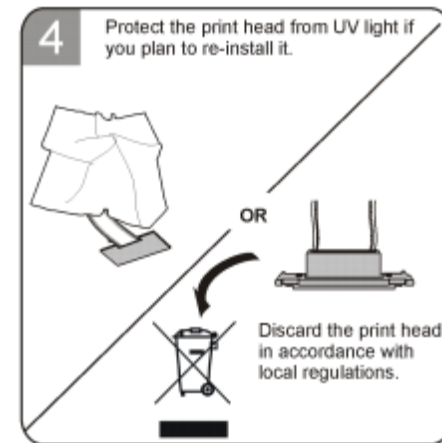
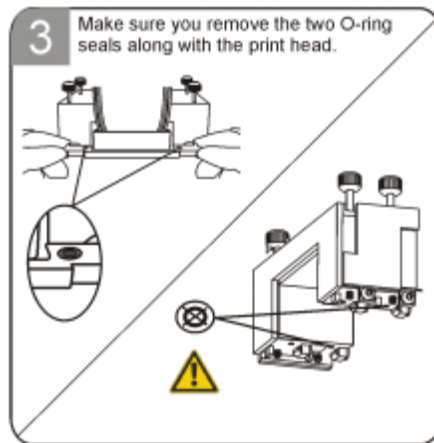
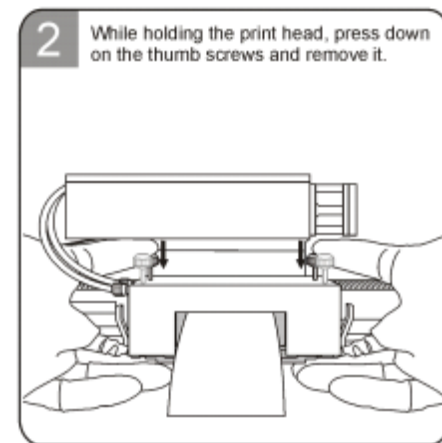
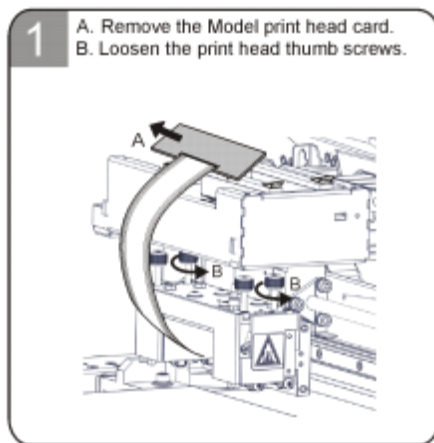

## Installing the Model Print Head

- **When re-installing a used print head, always replace the O-ring seals with *new* seals.**

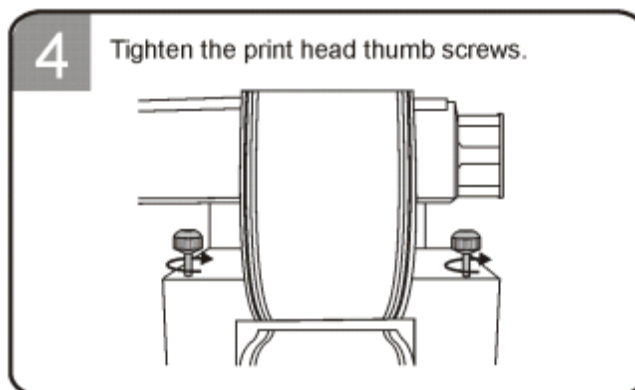
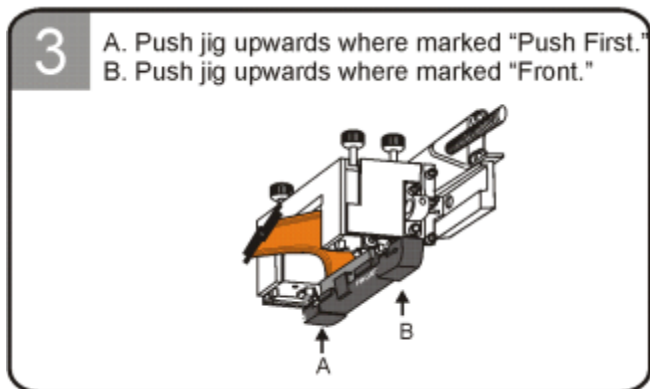
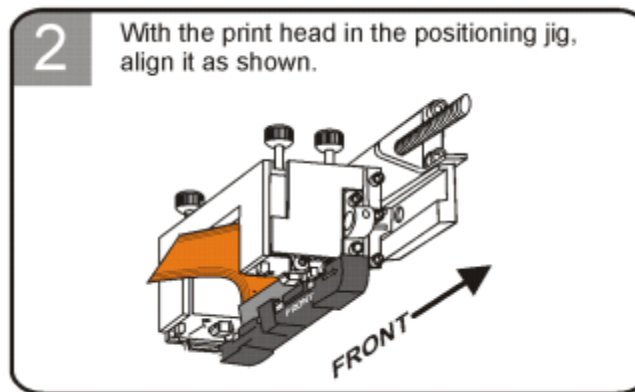
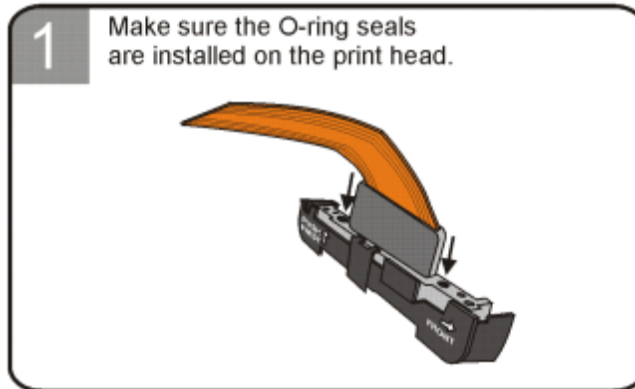

5

Press down firmly on the Model print head card to attach it to the print block.

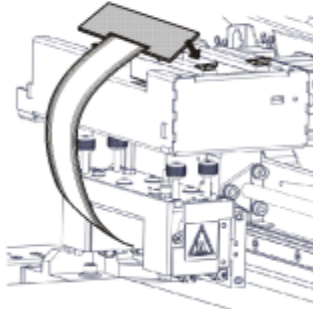

6

Push on the tab and then pull the jig downwards to remove it.

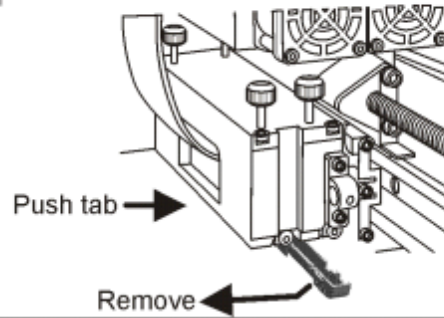

## Installing the Support Print Head

- **When re-installing a used print head, always replace the O-ring seals with *new* seals.**

**1** Make sure the O-ring seals are installed on the print head.

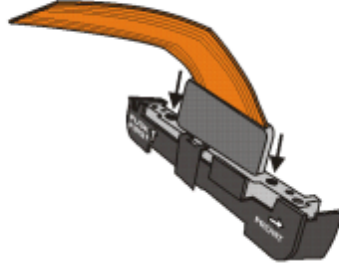

**2** With the print head in the positioning jig, align it as shown.

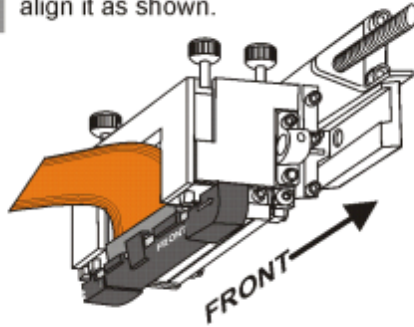

**3** A. Push jig upwards where marked "Push First."  
B. Push jig upwards where marked "Front."

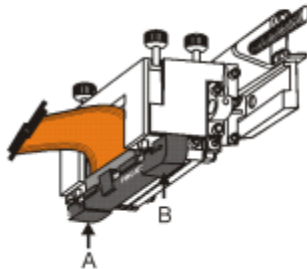

**4** Tighten the print head thumb screws.

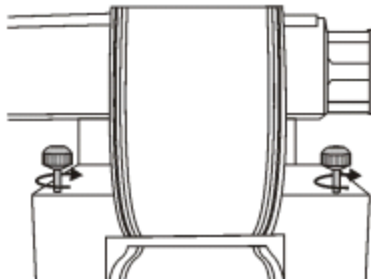

- 5** Press down firmly on the Support print head card to attach it to the print block.

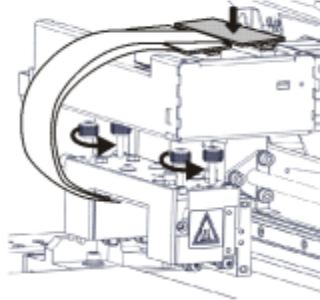

- 6** Push on the tab and then pull the jig downwards to remove it.

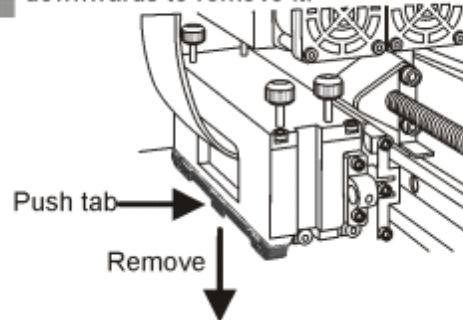

- 7** Install the print block cover.

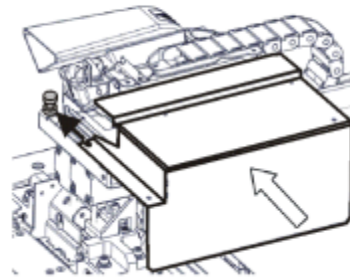

- 8** A. Insert and tighten screws A.  
B. Tighten screw B.

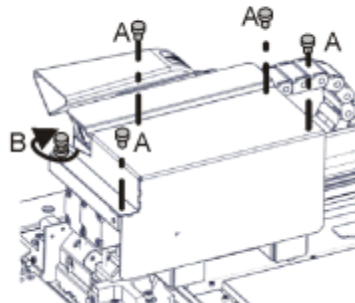



8. In the *Replace print heads* screen, select the check box to confirm that you have replaced the head(s), and click Next.

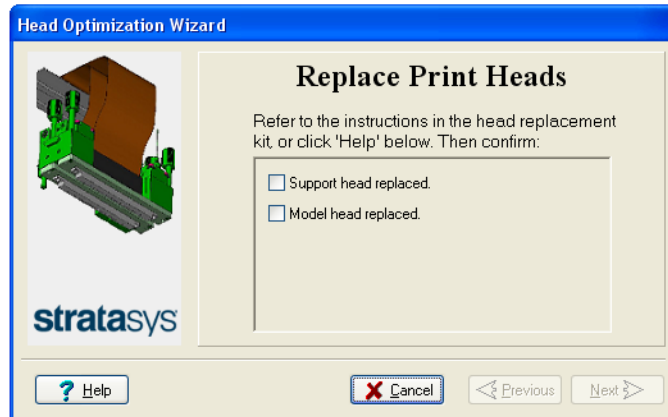

Figure 6-78 Head replacement confirmation

9. Confirm that the heads are level and even by selecting the check box in the following wizard screen, and click Next.

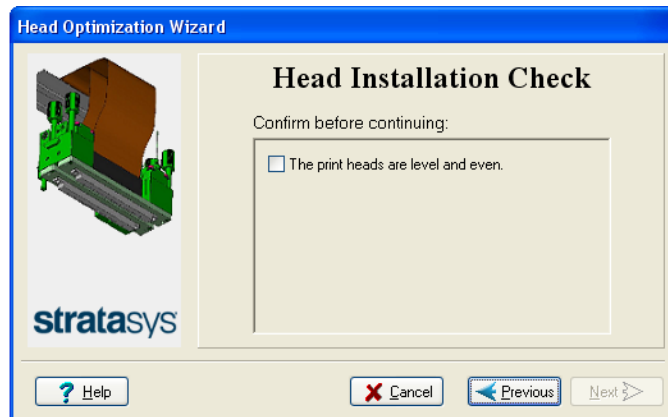

Figure 6-79 Installation-check screen

10. In the next wizard screen, confirm that you have removed all tools and objects from the printer and that the cover is closed.

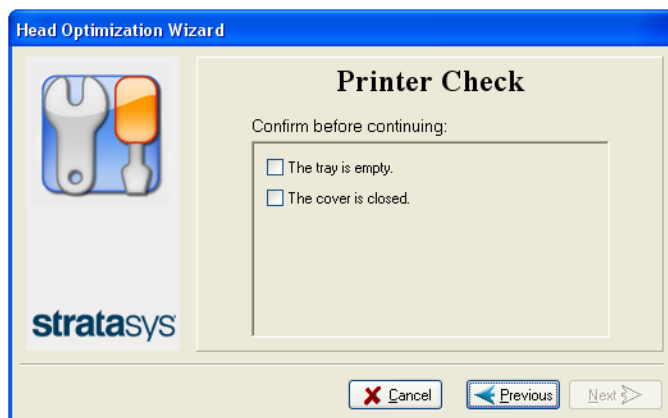

Figure 6-80 Cleared-tray confirmation screen

The wizard continues by heating the heads, then filling and purging them. If there are no installation problems, the optimization procedure begins, to

calibrate the print heads to the best working configuration—see "Optimizing (Calibrating) Print Heads" on page 6-43. After this procedure, you should run the Head Alignment wizard before printing models.

If installation problems are detected, the wizard alerts you and instructs you how to continue (see "Installation Problems", next).

**Installation Problems** If the printer detects that there is a problem after you install print heads, relevant warning screens appear.

- If the print head you installed is not new—that is, it was previously removed from a printer—the following message appears.

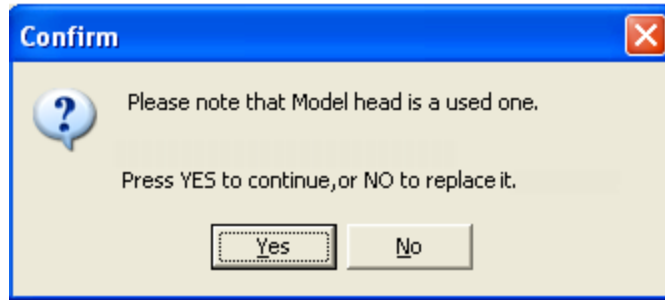

Figure 6-81 Used print head message

- To continue with the installation of this print head, click Yes.
- To remove this print head and install a new one, click No.
- If the printer software does not detect the replaced head, the following warning screen appears.

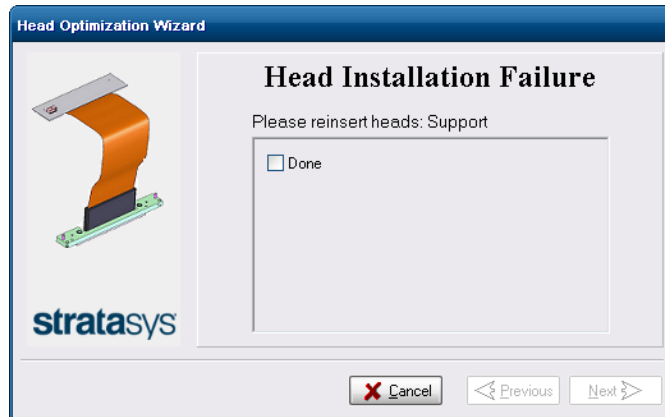

Figure 6-82 Incorrect-installation screen, showing which head(s) to re-insert

If this happens:

- Re-insert the print-head driver card into its socket.
- In the wizard screen, select the check box to confirm that you have re-inserted the card, and click Next.

## Testing and Calibrating the UV Lamp

The effective UV radiation from the lamp used for curing models can change over time. Too little UV curing can cause some of the printing material to remain in a liquid state, on models, when printing has finished. Test the lamp and calibrate its effective UV radiation after every 300 hours of printing, or when you suspect that this is necessary, by running the UV Calibration Wizard.

The wizard compares the measured radiation to the recommended radiation level. When calibrating the lamp, the wizard attempts to adjust the radiation level, if necessary.

- If the reading is within the acceptable range, the wizard continues.
- If further adjustment is necessary, the test is repeated.
- If the UV radiation is too low to be properly adjusted, the wizard indicates that the lamp's radiation for the printing mode is unacceptable.



Before testing and calibrating the UV lamp, make sure the glass lens is clean. For easy access, run the Head Cleaning Wizard, and use the special cleaning pad supplied.

To test and calibrate UV lamp radiation:

1. Start the UV Calibration Wizard from the *Options* menu (see on page 6-31).
2. In the following screen, select UV Intensity Calibration to adjust the lamp's radiation level to the acceptable range.



Figure 6-83 UV Test/Calibration selection

3. Make sure that the build tray is clear (empty). Confirm this in the wizard screen and click Next.

The following screen appears.

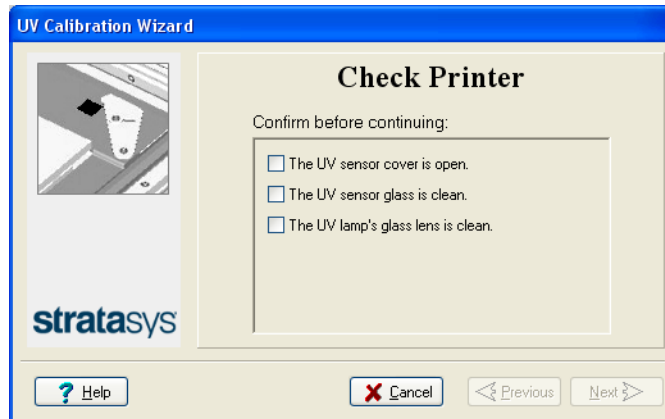

Figure 6-84 Printer preparation

4. Expose the UV sensor by sliding its cover to the right, and check that the glass is clean.



Figure 6-85 UV sensor exposed

5. If necessary, clean the glass over the UV sensor with a cleaning cloth and alcohol (IPA).

Do *not* use the abrasive cleaning pad to clean the glass.

When you click **Next**, the UV lamp powers up and stabilizes. (This takes several minutes.) Then, the print block passes over the sensor and the wizard compares the measured radiation to the recommended level.

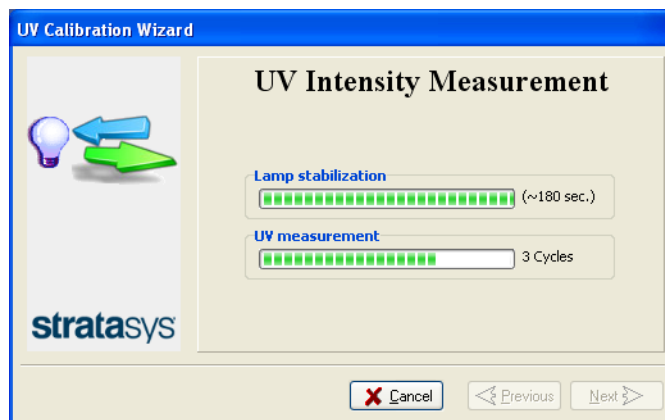

Figure 6-86 UV measurement progress

If the UV level measured is not acceptable, the wizard calibrates the UV lamp by adjusting the current supplied to it, and then tests it again.

When completed, the wizard displays the condition of the lamp, after calibration.

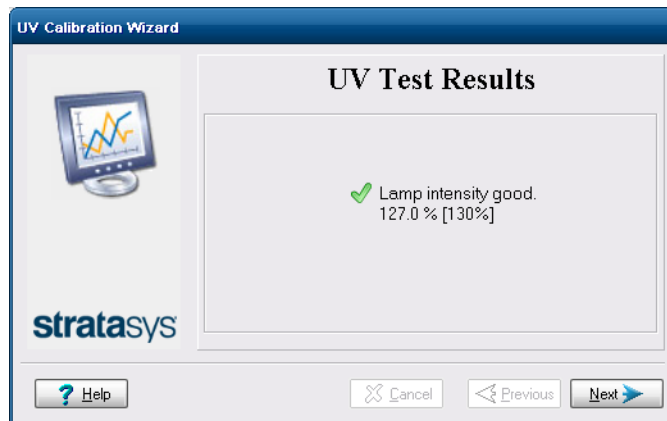

Figure 6-87 Final condition of UV lamp—acceptable intensity level

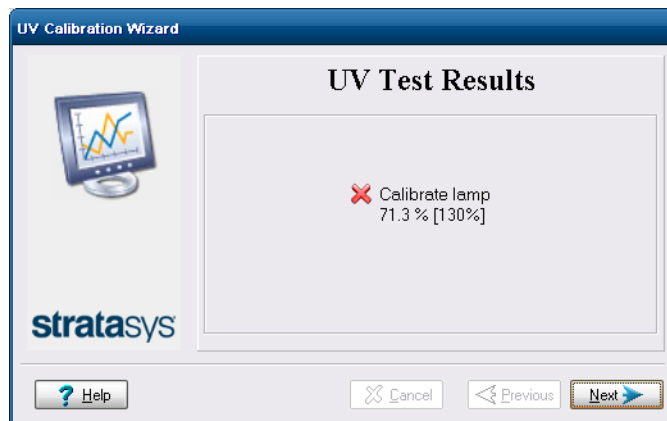

Figure 6-88 Final condition of UV lamp—unacceptable intensity level

6. If the wizard cannot adjust the lamp to within the specified UV intensity range, perform the following steps and run the wizard again before replacing the lamp:
  - Check that the UV-lamp glass is clean.
  - Check that the UV sensor is completely uncovered and that the protective glass is clean.
 If the results are still unacceptable, contact customer support for advice.
7. Click Next, close the UV sensor cover, and confirm this in the wizard screen. Then click Next to complete the wizard.



Figure 6-89 Final UV Calibration Wizard screen

## Calibrating the Load Cells

Load cells are sensors that measure the weight of the material cartridges and the waste container in the printer. It is important that you periodically check that the weight measurements are accurate to prevent unnecessary waste of printing materials. It is recommended that you calibrate the load cells after 500 hours of printing, or every six months.

To calibrate load cells:

1. Start the Load Cell Calibration wizard from the *Options* menu.
2. Select one or more load cells that you want to calibrate, and click Next.

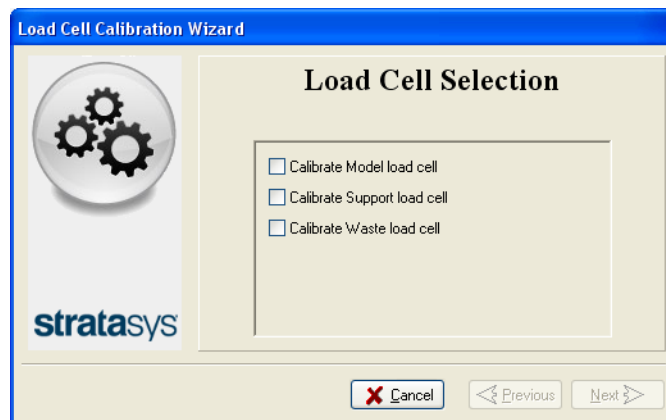

Figure 6-90 Load cell selection

3. Remove the cartridge, as instructed by the wizard, and close the materials drawer.

**Important:** Make sure that the materials drawer is closed before continuing. Otherwise, calibration will be affected.

4. Select the confirmation check box and click Next.

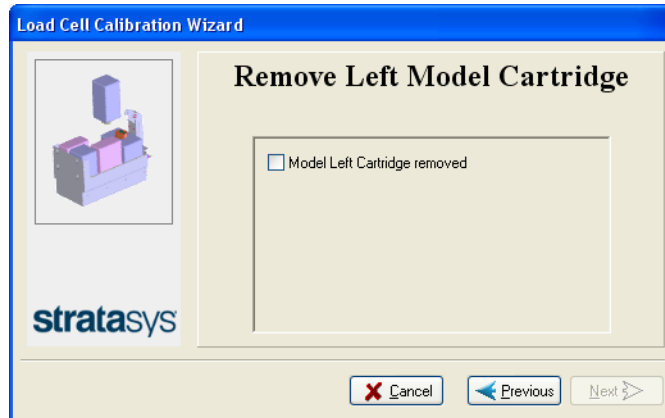

Figure 6-91 Confirmation of cartridge removal

5. In the next wizard screen, observe the numbers and wait until the level is relatively stable—two units above or below the average level shown.

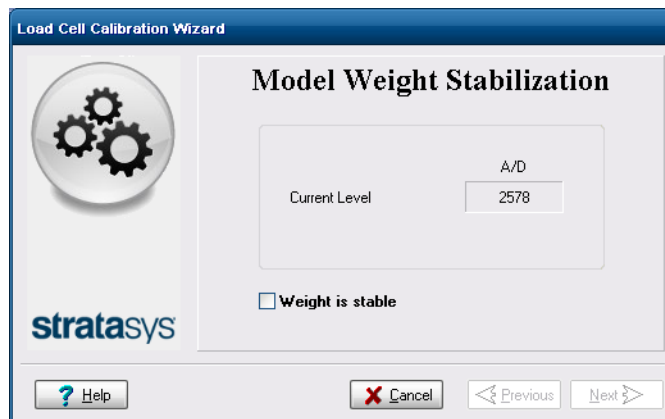

Figure 6-92 Level stabilization

6. Select the check box, and click Next.  
If you need to calibrate more than one load cell, the next calibration screen appears. Repeat steps 5 and 6 until all of the load cells are calibrated.
7. Click Done in the final wizard screen.

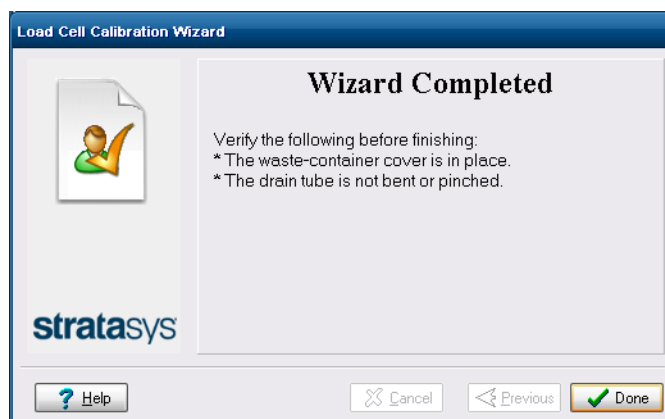

Figure 6-93 Final wizard screen

## 8. Replace the cartridge.



- When replacing the waste container, hold the waste bag with one hand while connecting the waste tube. Otherwise, the bag will be twisted, and the flow of waste will be restricted.
- Make sure to replace the metal cover over the waste container. Operating the printer without the cover results in an inaccurate measurement of the waste weight, which will cause waste to overflow into the printer.

## Replacing the Odor Filter

If the printer exhaust is not connected to an external ventilation system, a built-in activated-carbon filter removes odors from printing materials. This filter should be replaced regularly (as necessary) to keep your working environment pleasant. This is normally done during the preventive-maintenance routine.

To replace the odor filter:

1. Locate the filter drawer at the rear of the printer and pull it open.



Figure 6-94 Rear of the cartridge printer

2. Remove the used filter. (You can push it out from underneath the drawer.)

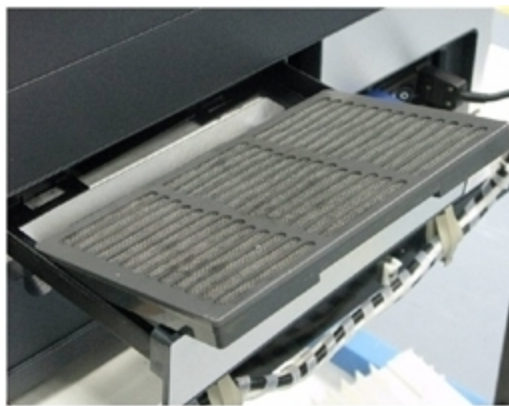

Figure 6-95 Odor filter in drawer

3. Insert a new filter and close the drawer.



## Replacing the UV Lamp

The UV lamp used for curing models has a long, but limited, working life. You can test and adjust its effective power with the UV Calibration wizard (see "Testing and Calibrating the UV Lamp" on page 6-62). If you need to replace the UV lamp, follow these instructions:

1. Start the UV Lamp Replacement wizard from the *Options* menu (see "Starting the Material Replacement wizard" on page 6-14).



### Warning

Before continuing, make sure that the safety interlock in the printer cover is not defeated, and that the lamp is not hot.

2. Make sure that the build tray is empty, and confirm this in the wizard screen. Then, close the printer cover and click **Next**.

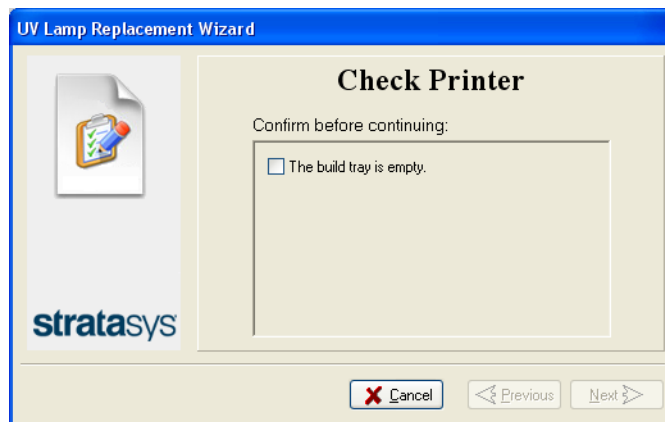

Figure 6-96 "Empty tray" confirmation screen

The axes move to the "home" position.

3. On the UV-assembly cover, loosen (do **not** remove) the thumbscrew indicated in the photograph below.



Figure 6-97 UV-assembly cover

4. Remove the other four (4) thumbscrews that secure the UV-assembly cover, and remove the cover.

5. Disconnect the UV lamp cable and the fan cable.

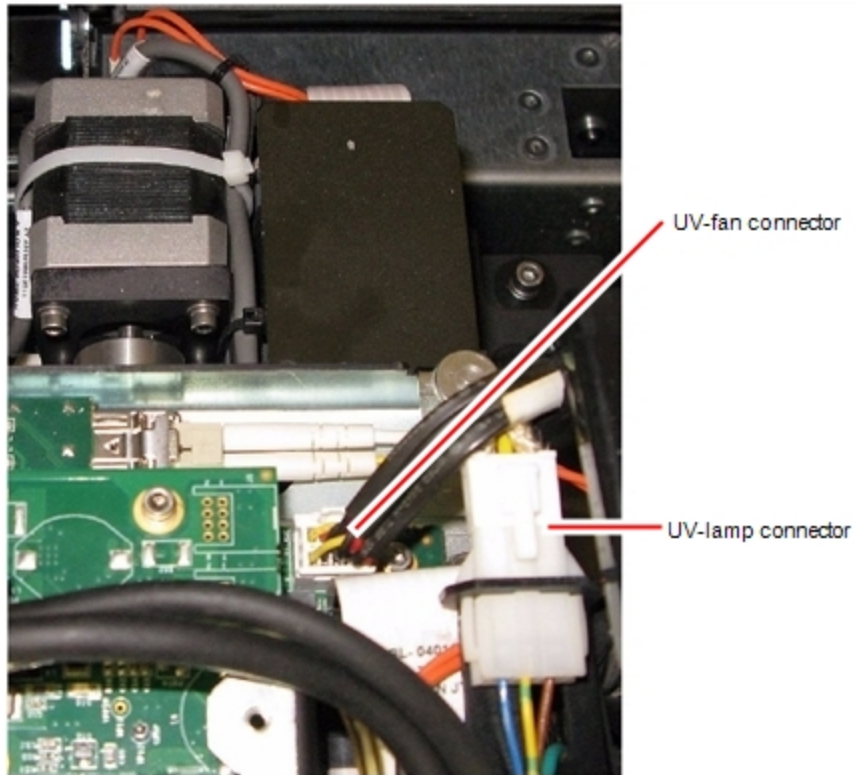

Figure 6-98 Disconnecting the UV lamp assembly (top view)

6. Loosen the two side screws securing the UV lamp assembly to the printer.



Figure 6-99 UV-lamp-assembly

7. Remove the assembly, and place it on a flat surface.

8. Loosen the screws securing the UV lamp cover and remove the cover.

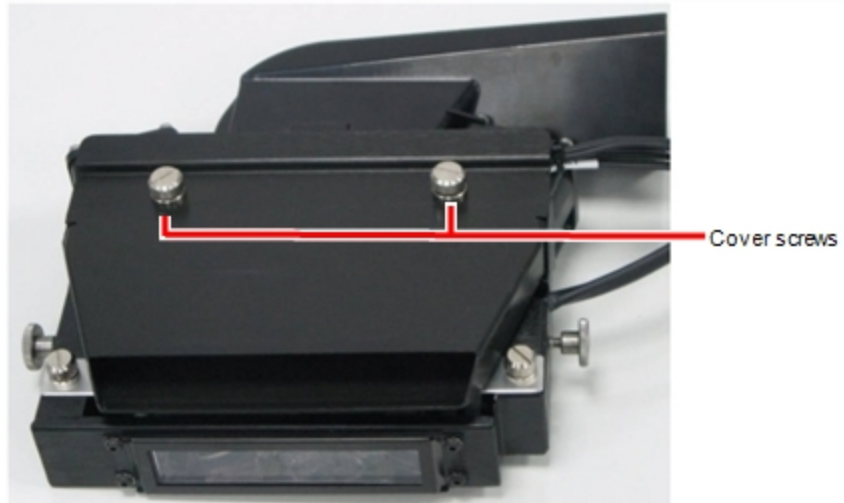

Figure 6-100 UV-lamp-cover screws

9. Loosen the two screws securing the UV reflector.

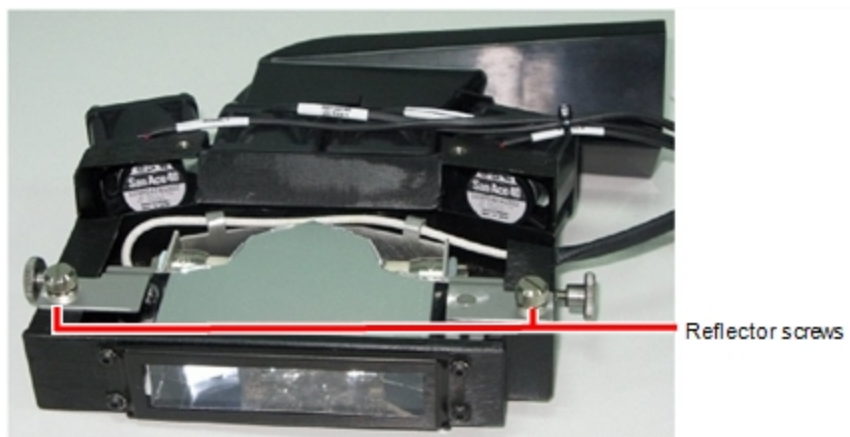

Figure 6-101 UV-reflector screws

10. Remove the UV reflector by raising it slightly, then pulling it out of the housing at an angle, from the bottom.



Figure 6-102 Removing the UV reflector from the UV assembly

11. Discard the old UV reflector and lamp.



Dispose of the used UV lamp in accordance with environmental and safety requirements.



### **Warning: Broken UV lamp hazard**

UV lamps contain mercury. Deal with broken lamps with caution.

- Ventilate the room thoroughly.
- Use protective gloves when collecting mercury and lamp components.
- Remove spilled mercury with a method that prevents the generation of mercury vapor, such as a syringe, packing tape or paper.
- Place the broken lamp, mercury and contaminated materials in an air-tight, non-metallic container.

12. Insert the new UV lamp/reflector unit into the housing.
13. Make sure that the UV-lamp cable is in place, inside the housing, and then tighten the securing screws.

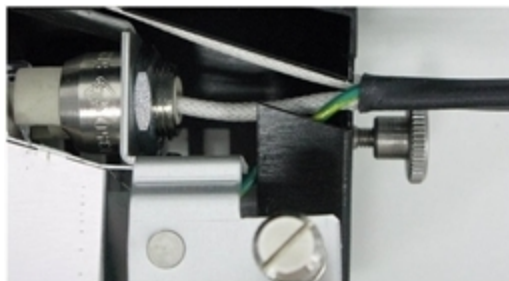

Figure 6-103 Cable position when installing the UV lamp

14. Replace the UV lamp cover, and tighten the securing screws.

15. Replace the UV lamp assembly in the printer, making sure that the cable fits into the slot together with the side securing screw.



Figure 6-104 UV-lamp cable after replacing the assembly

16. Tighten the two side securing screws.
17. In the wizard screen, confirm that you have replaced the UV lamp and that the black strip is attached, then click Next.

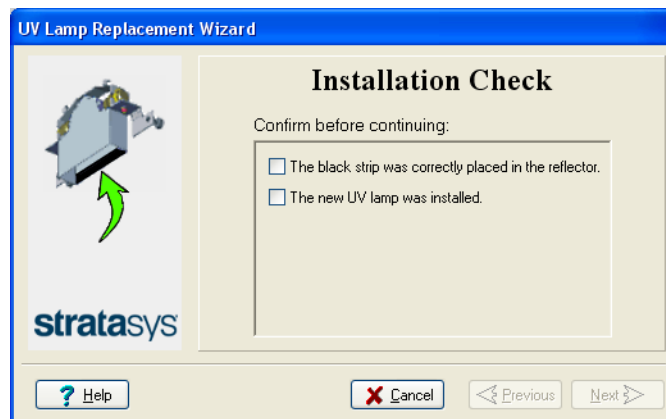

Figure 6-105 UV-installation confirmation screen

The wizard operates the lamp to test if it is installed correctly. If the lamp does not light, the wizard prompts you to check the power connections and to re-install the lamp.

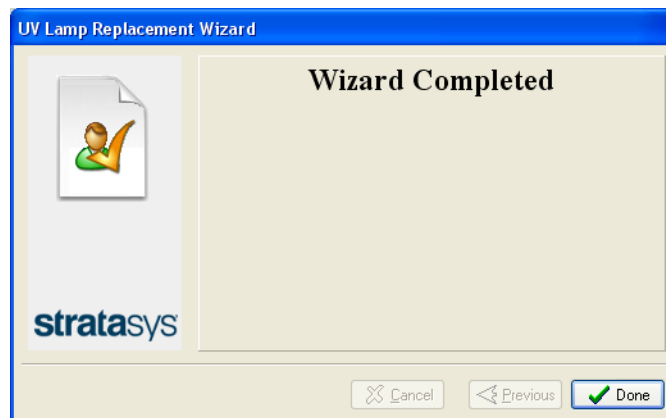

Figure 6-106 Final wizard screen

**Note:** The UV lamp remains on until you click Done.



#### After replacing the UV lamp:

- Calibrate its power by running the UV Calibration wizard (see "Testing and Calibrating the UV Lamp" on page 6-62). *Wait at least two minutes for the UV lamp to cool before starting the UV Calibration wizard.*
- Calibrate the new UV lamp again after 100 hours of printing.

## Replacing the Material Filter

The Model and Support filters are replaced during the periodic preventive maintenance routine (see "Preventive Maintenance Tasks" on page 6-98).

The material filters are located at the back of the materials drawer, as shown below.

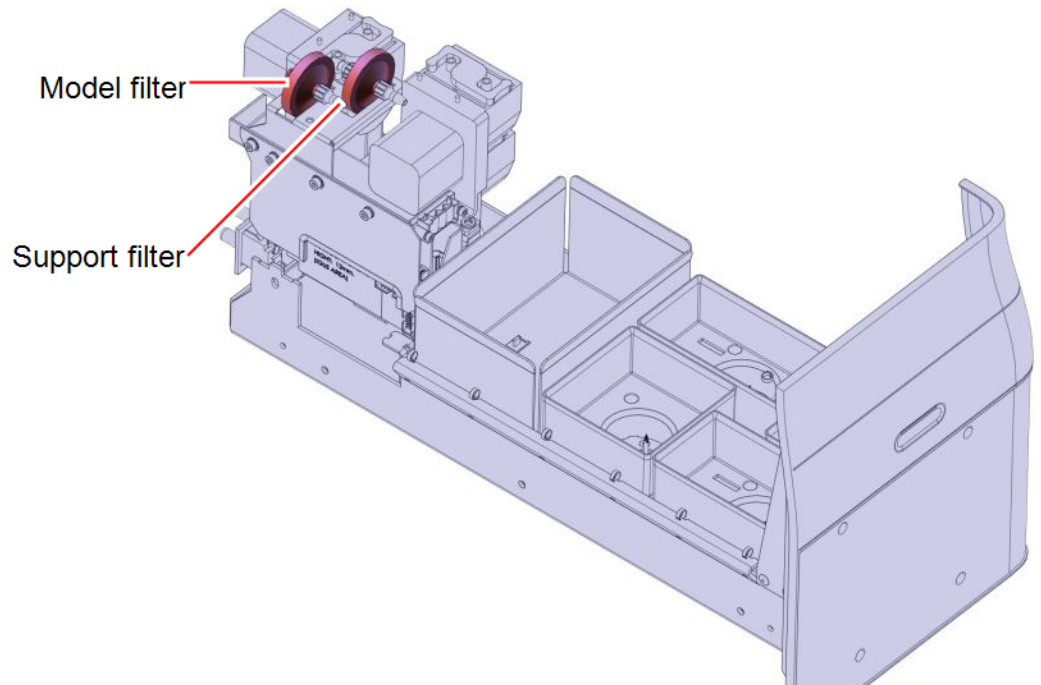

Figure 6-107 Material filters

1. Prepare the following tools and materials:
  - protective gloves
  - cleaning cloths
  - wire cutter
  - paper towels
  - two replacement filters and cable ties (supplied in the preventive maintenance kit)



The Model and Support filters supplied in the preventive maintenance kit are identical.



2. Close the printer application.
3. Shut down the printer computer, wait 60 seconds after the monitor goes blank, and turn off the main power switch.

**Caution:**

The monitor goes blank as soon as the remote desktop link terminates—before computer shutdown. Turning off the printer before computer shutdown can cause damage.

4. Put on protective gloves.

**Warning: Toxic and Corrosive Materials**

Prolonged contact with resins could cause skin irritation. Put on protective gloves before continuing.

5. Open the materials drawer.
6. Remove the cover from the waste container.

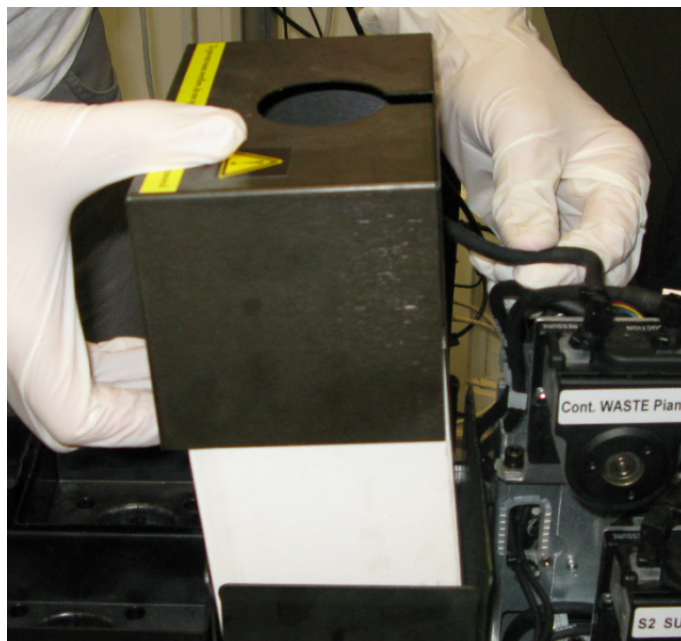

Figure 6-108 Removing the waste container cover

7. Unscrew the cap connecting the waste-drain tube to the container.
8. Carefully lift out the container and remove it from the printer.
9. Place paper towels in the waste compartment to absorb any material leaks.

10. Extend the materials drawer to the end of its track, as follows:
  - a. Push the drawer slightly inward.
  - b. Lift the extension latch and pull out the drawer, all the way.

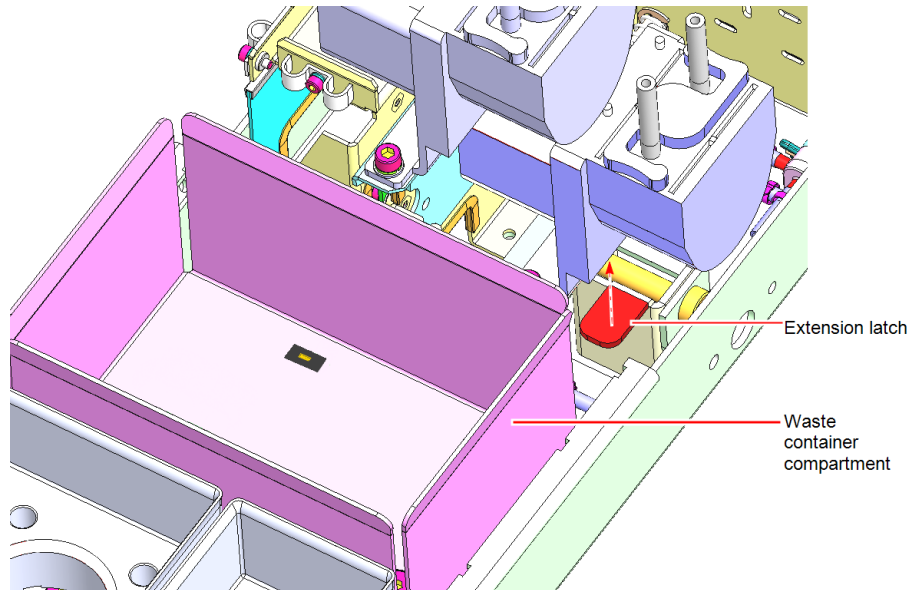

Figure 6-109 Materials drawer extension latch

11. Remove the cable tie securing the Model and Support filters to the printer.

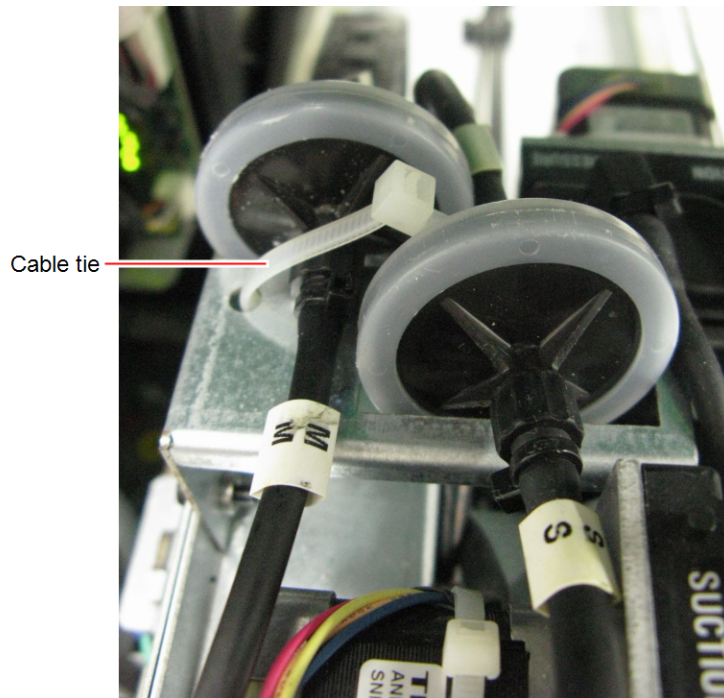

Figure 6-110 Material filters secured to the printer



12. Disconnect the feed tube from the Model material filter, as shown.

**Important:**

To disconnect the feed tube, hold the fitting at the end of the tube in place and turn the filter. Otherwise, the feed tube will be twisted and material might leak.

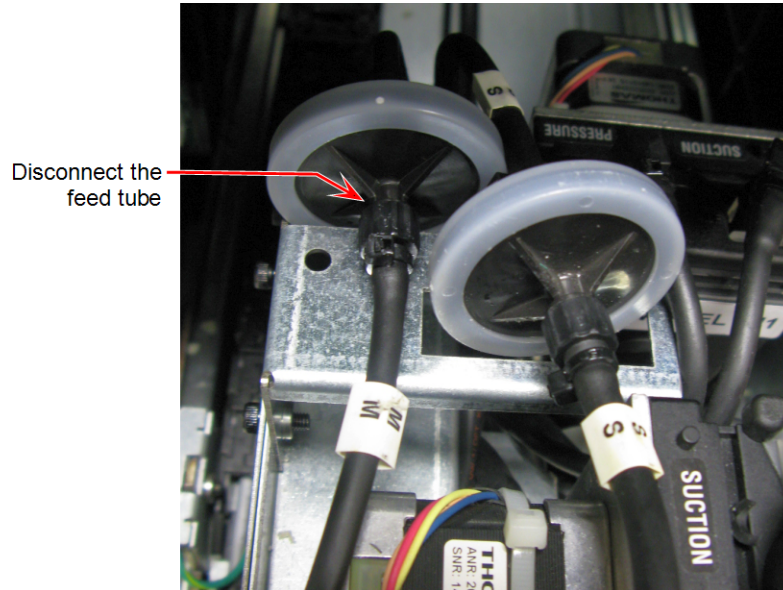

Figure 6-111 Model and Support material filters

13. Make sure that the fitting at the end of the feed-tube remains attached to the tube. Re-attach it, if necessary.
14. Cover the filter with a cleaning cloth (or paper towels) to absorb material spillage.
15. On the new filter, identify the side marked INLET.

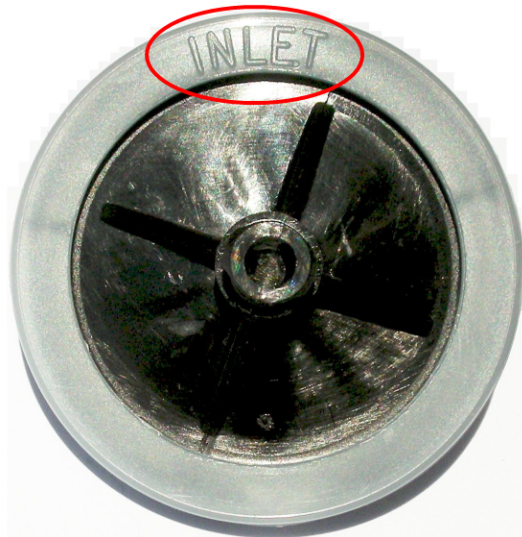

Figure 6-112 Inlet side

16. Attach the inlet side of the new filter to the disconnected tube.

**Important:**

To attach the filter, hold the fitting at the end of the feed tube in place and turn the filter. Otherwise, the feed tube will be twisted and material might leak.

17. Disconnect the old filter from the outlet tube.

18. Discard the old filter



**Caution:**

The filter contains uncured printing material. Discard the filter in accordance with applicable environmental regulations.

19. Cut and remove the cable tie securing the fitting at the end of the outlet tube.



Figure 6-113 Tube with cable tie and fitting

20. Remove the fitting from the end of the tube.

21. Attach the fitting to the new filter.

**Important:**

To attach the filter, hold the fitting at the end of the feed tube in place and turn the filter. Otherwise, the feed tube will be twisted and material might leak.

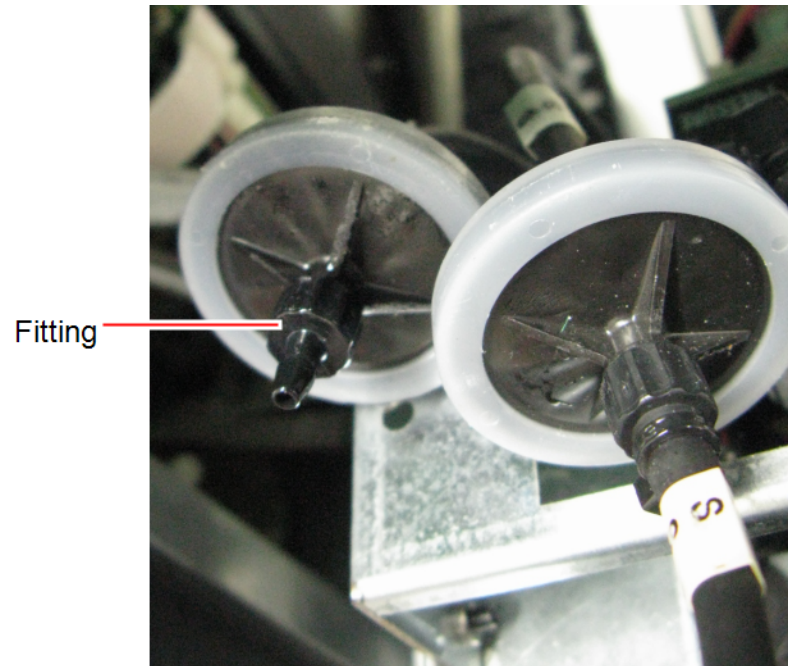

Figure 6-114 Fitting attached to the new filter

22. Attach the outlet tube to the fitting.

Make sure that the tube is firmly attached by pushing it onto the entire length of the fitting shaft.

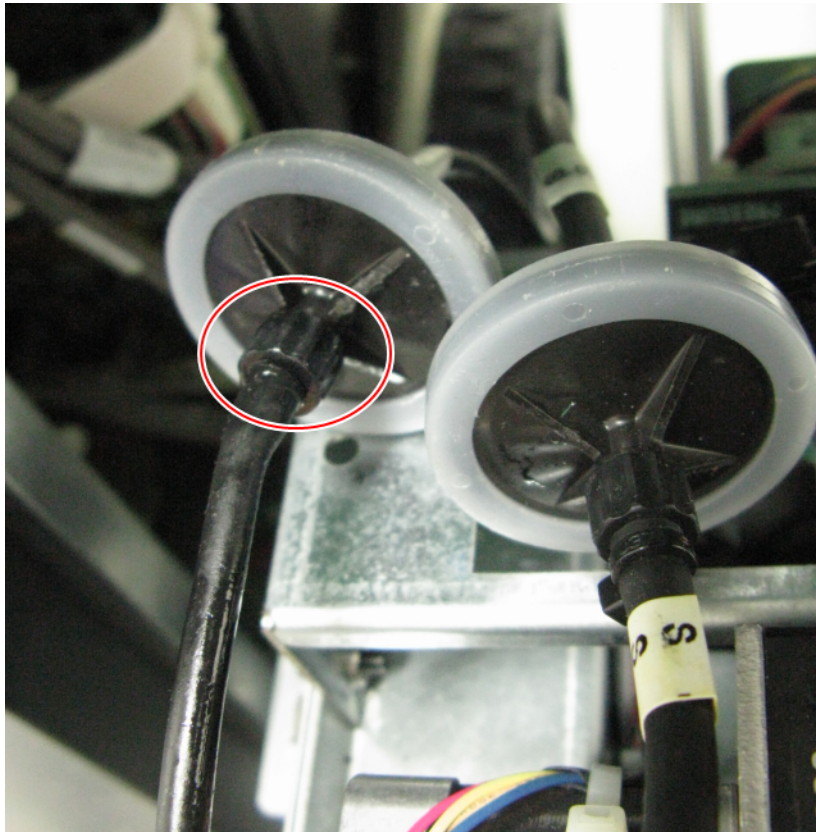

Figure 6-115 Tube attached to the new filter

23. Secure the tube to the fitting with a cable tie. Cut off excess length.

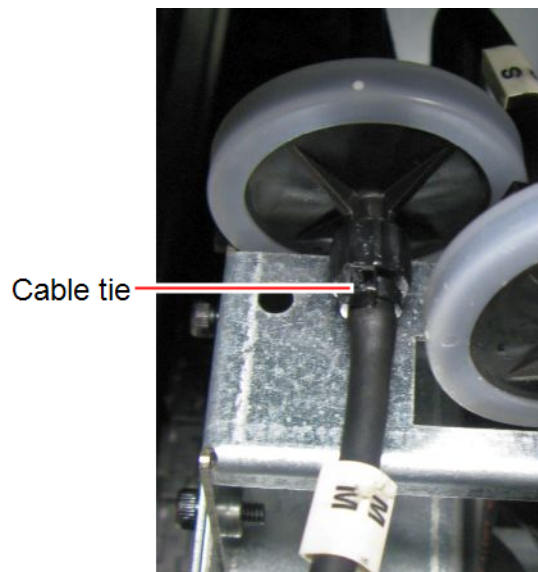

Figure 6-116 Tube secured with a cable tie

24. Repeat steps 2–13 to replace the Support filter.



25. Wipe the filters, tubes and surrounding area to remove material leaks and spills.
26. Position the filters in their slots.

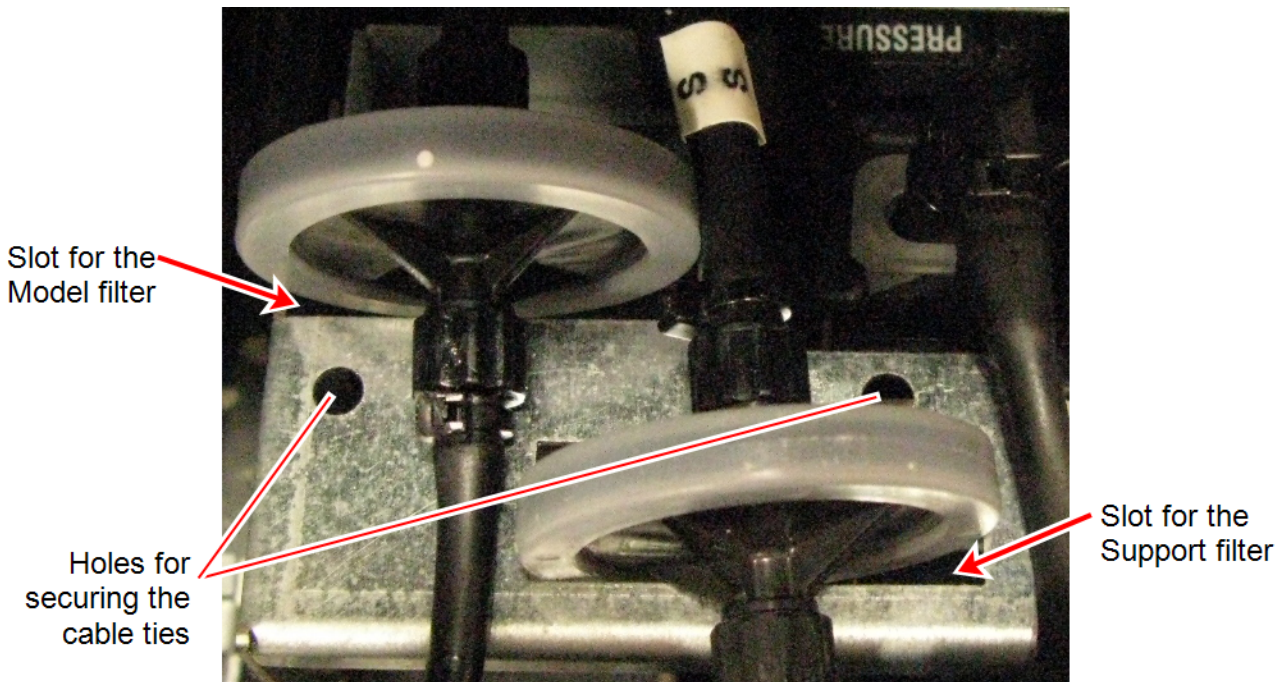

Figure 6-117 Material filters positioned in the printer

27. Secure both filters to the printer with a long cable tie. Cut off excess length.

To secure both filters properly, route the cable tie through the holes in the filter holder (see Figure 6-117).

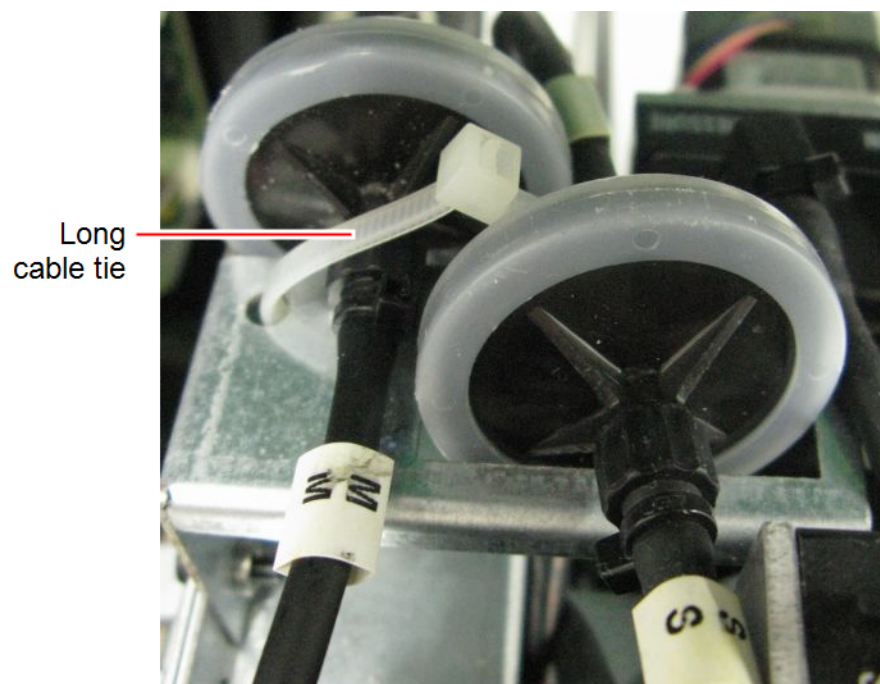

Figure 6-118 Filters secured in the printer

To return the printer to operating mode:

1. Place the waste container in the materials drawer, and attach the cap connected to the drain tube.

**Important:**

Hold the waste bag with one hand while attaching the waste tube. Otherwise, the bag will be twisted and the flow of material will be restricted.



Figure 6-119 Attaching the waste drain tube

- Place the cover over the waste container, and make sure that the drain tube is free and not bent.

**Important:**

Operating the printer without the waste container cover results in an inaccurate measurement of the waste weight, which will cause waste to overflow into the printer.



Figure 6-120 Cover installed on the waste container

- Close the materials drawer.

## Replacing the Pump Tubes

Pump tubes in Objet30 Desktop V3 printers are replaced during periodic preventive maintenance (see "Preventive Maintenance Tasks" on page 6-98).

To replace the pump tubes:

- Prepare the following tools and materials:
  - key
  - flat screwdriver
  - protective gloves
  - cleaning cloths
  - wire cutter
  - three replacement tubes and cable ties



The three tubes supplied in the kit are identical; they can be used in the pumps described in this section.

2. Close the printer application.
3. Shut down the printer computer, wait 60 seconds after the monitor goes blank, and turn off the main power switch.

**Caution:**

The monitor goes blank as soon as the remote link terminates—before computer shut down.

Turning off the before the computer shutdown can cause damage.

4. Open the materials drawer.

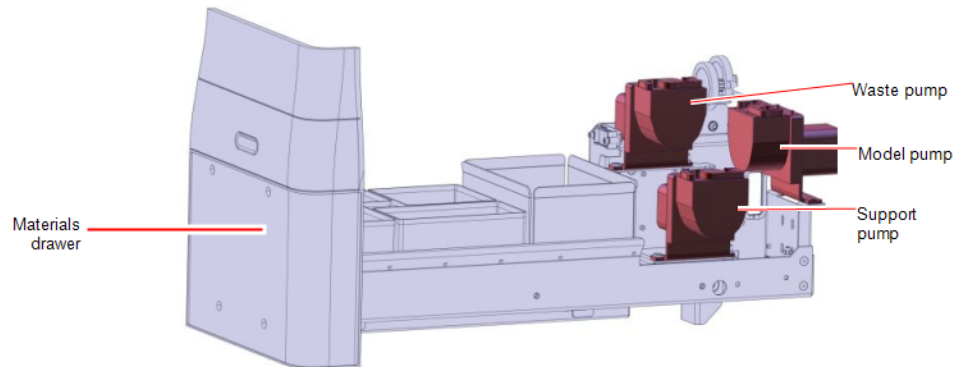

Figure 6-121 Material pumps

5. Remove the three screws securing the right printer panel and remove the panel.

**Caution:**

Remove the screws carefully so that they do not fall and scratch the printer panel.

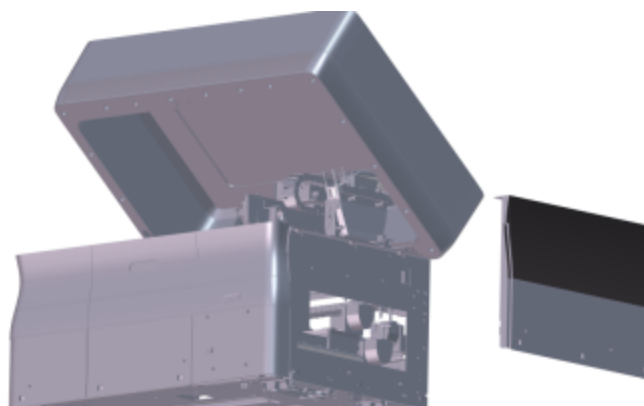

Figure 6-122 Removing the right printer panel



- Put on protective gloves.

**Warning: Toxic and Corrosive Materials**

Prolonged contact with resins could cause skin irritation. Put on protective gloves before continuing.

- Remove the cover from the waste container.

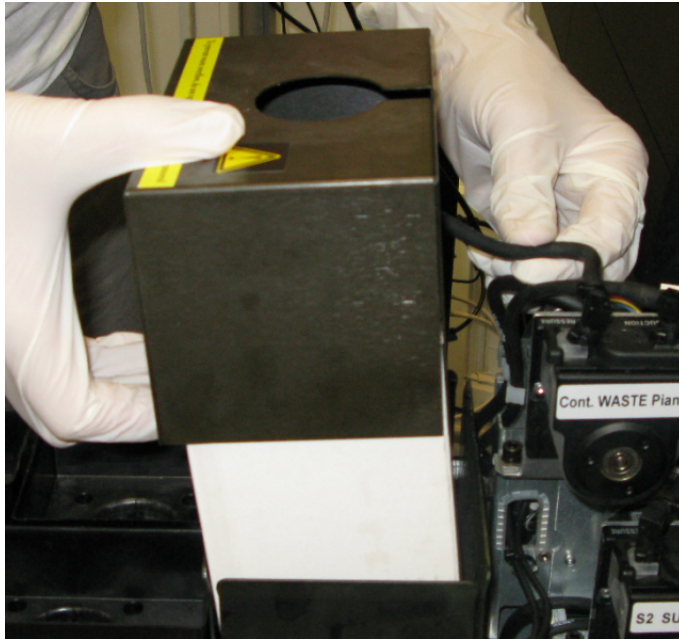

Figure 6-123 Removing the waste container cover

- Unscrew the cap connecting the waste tube to the container.
- Carefully lift out the container and remove it from the printer.
- Place cleaning cloths in the waste compartment to absorb any material leaks.

11. Extend the materials drawer to the end of its track, as follows:
  - a. Push the drawer slightly inward.
  - b. Lift the extension latch and pull out the drawer, all the way.

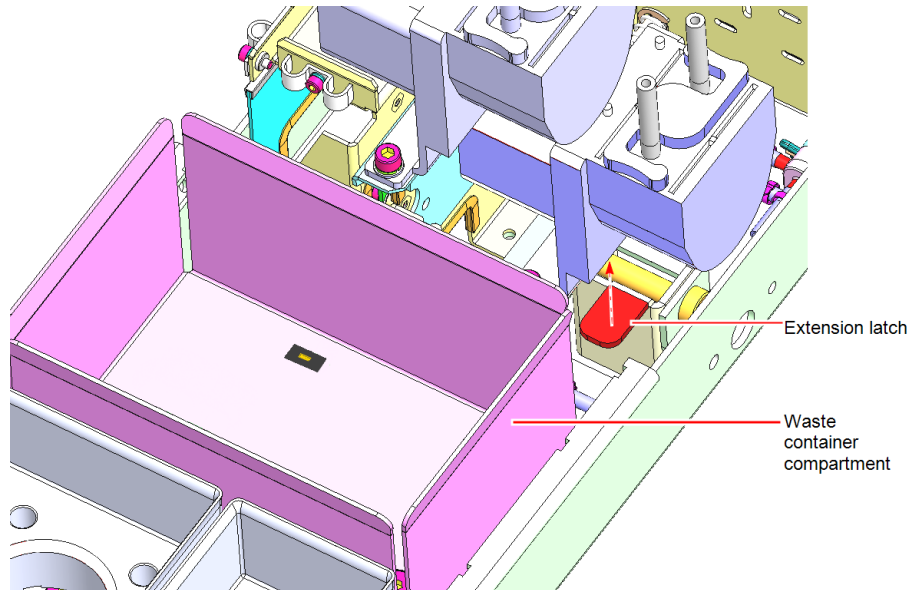

Figure 6-124 Materials drawer

#### Waste Pump Tube

To replace the waste pump tube:

1. On top of the waste pump, locate the tube near the PRESSURE label.



Figure 6-125 Tubes connected to the waste pump

2. Label (mark) the tube.

3. Carefully cut and remove the cable ties on the ends of the tube extending from the pump.



Figure 6-126 Waste pump

4. Disconnect the tubes with their fittings from the ends of the tube extending from the pump.



If you experience difficulty disconnecting the tube fittings from tubes in the pump, make a small slit in the tube, as shown.



Figure 6-127 Tubes disconnected from the waste pump

5. Release the tube latch, as shown.

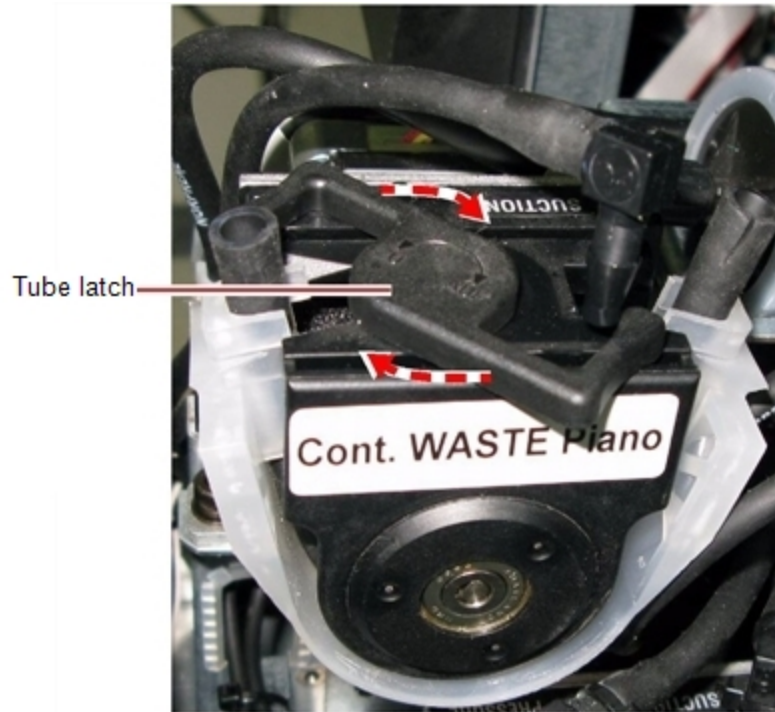

Figure 6-128 Releasing the tube latch

6. Remove the pump tube with its holder from the pump assembly.



Figure 6-129 Removed tube and tube holder

7. Remove the tube from the tube holder and discard the tube.



**Caution:**

The tube contains uncured printing material. Discard it in accordance with applicable environmental regulations.

8. Attach a new tube to the tube holder.



Make sure that the tube extends equally on each side of the tube holder.

9. Insert the tube holder into the pump assembly.
10. Close the tube latch.

When the latch is closed, you should hear a clicking sound.



**Caution:**

Crimped tubes can cause material leaks that can damage the printer. When securing the tube latch, make sure that you do not crimp (pinch) the surrounding tubes.

11. Attach the tube you labeled in step 2 to the tube extending from the pump near the PRESSURE label.
12. Attach the other tube to the tube extending from the pump near the SUCTION label.
13. Secure each tube to its fitting with a cable tie. Cut off excess length.
14. Remove the label you attached in step 2.

Support Pump  
Tube

To replace the support pump tube:

1. Close the drawer approximately half way so that the Support pump is accessible from the opening in the chassis on the right side of the printer.

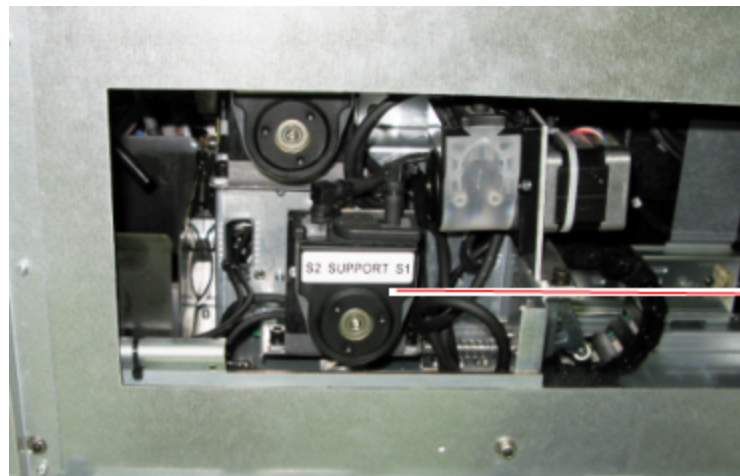

Support pump

Figure 6-130 Right side of printer

2. On the Support pump, locate the tube near the PRESSURE label.
3. Label (mark) the tube so that you can connect it correctly later on.

The replacement procedure is the same as for the waste pump. Continue with step 2 on page 6-85.

**Model Pump  
Tube**

To replace the model pump tube:

1. At the back of the Model pump, remove the screw shown below, using a 4-mm hex (Allen) key.

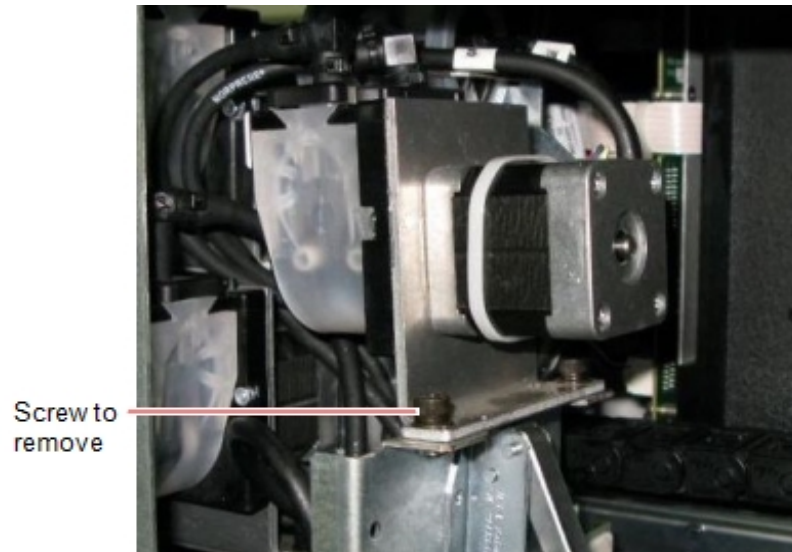

Figure 6-131 Model pump—securing screw to remove

2. Loosen (do not remove) the other securing crew.

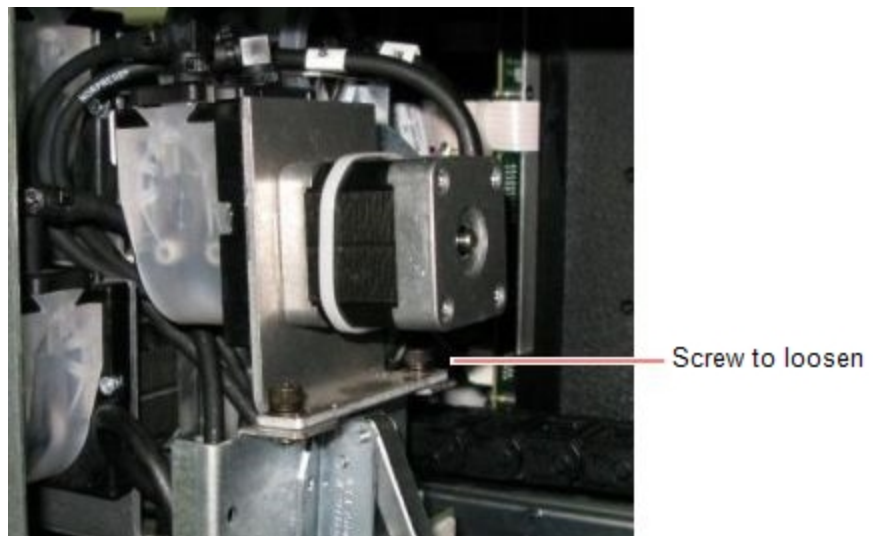

Figure 6-132 Model pump—securing screw to loosen



3. Turn the Model pump assembly so that the pump is facing you.

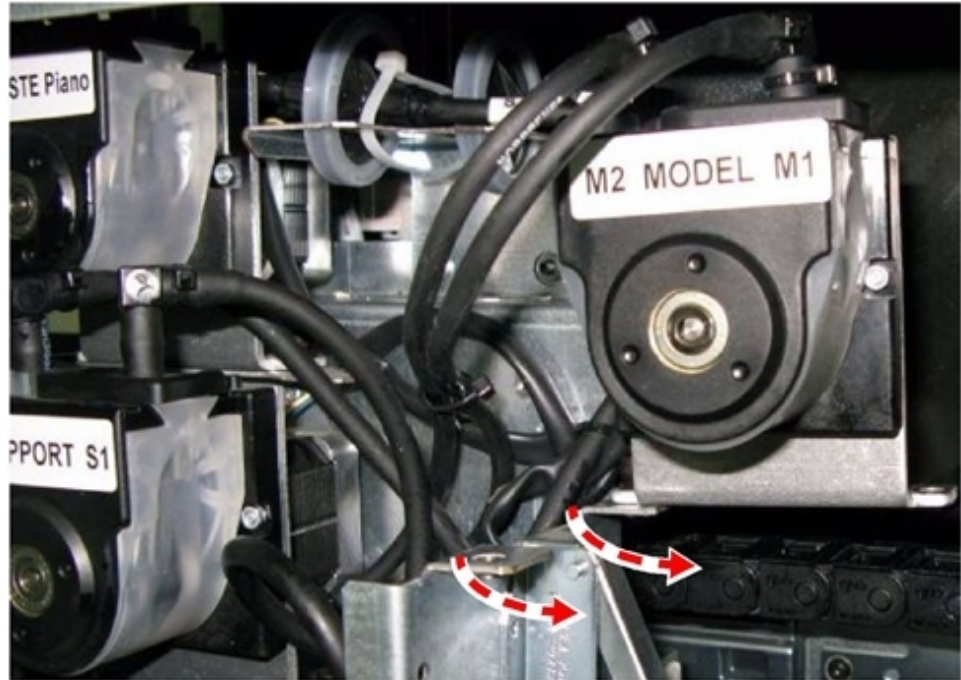

Figure 6-133 Model pump assembly turned

4. On the top of the Model pump, locate the tube near the PRESSURE label.
5. Label (mark) the tube.

The replacement procedure is the same as for the waste pump. Continue with step 2 on page 6-85, and then return the pump to its working position.

To return the Model pump to its working position:

1. Turn the Model pump so that it is facing the drawer.

2. Secure the Model pump to the printer with two screws.  
Insert and tighten the securing screw you removed before, and tighten the screw that you loosened.

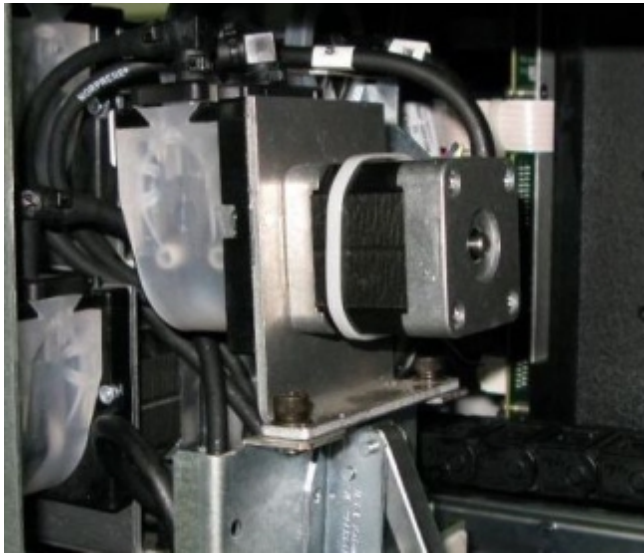

Figure 6-134 Model pump in the working position

#### Returning Printer to Working Order

To return the printer to working order:

1. Remove the cleaning cloths from the waste compartment and make sure that the compartment is clean.
2. Place the waste container in the materials drawer, and attach the cap connected to the drain tube.

#### **Important:**

Hold the waste bag with one hand while attaching the waste tube. Otherwise the bag will become twisted, and the flow of material will be restricted.



Figure 6-135 Waste container with waste tube attached



3. Place the cover over the waste container, and make sure that the drain tube is free and not bent.

**Important:**

Operating the printer without the waste container cover results in an inaccurate measurement of the waste weight, which will cause waste to overflow into the printer.



Figure 6-136 Cover installed on the waste container

4. Attach the right printer panel.



Make sure that the materials drawer is open while you attach the panel.

5. Close the materials drawer.
6. Make sure that the right panel and the drawer are aligned properly.
7. Switch on the printer.

**Important:**

Switching on the printer activates the waste pump and stops working when you open the printer application. If you hear unusual noises from the pumps when switching on the printer, verify that the waste pump tube holder is installed properly. If necessary, remove the tube holder and re-install it.

8. Open the printer control application.

**Important:**

If you hear unusual noises from the area of the pumps during printing verify that the Model pump or Support pump tube holders are installed properly. If necessary, remove the tube holders and re-install them.

**Built-in Tests** A sanity check of the software parameters is available from the Built-in Tests interface. Because this affects the operation of the printer, you can only open the Built-in Tests interface when the system is not printing.

**Accessing Built-in Tests** To open the Built-in Tests screen, do one of the following:

- From the *Options* menu, select Built-In Tests.
- Press Ctrl+Alt+B.

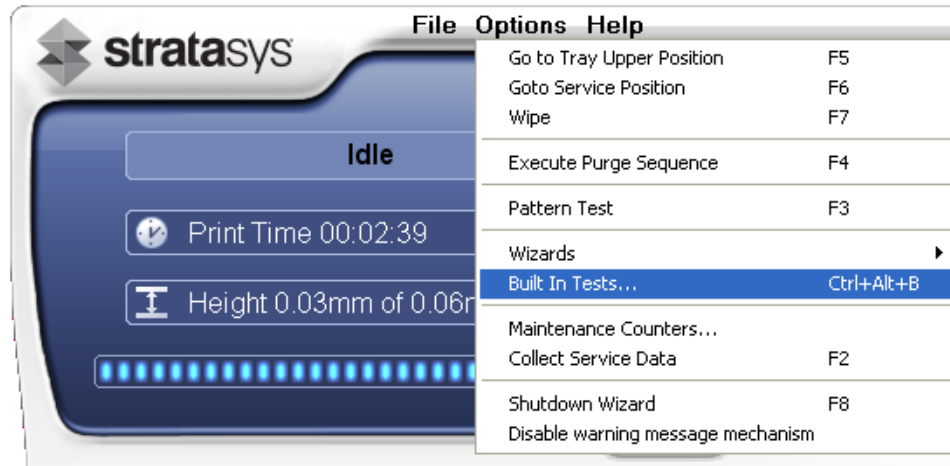

Figure 6-137 Selecting *Built-In Tests* from the *Options* menu

The *Built In Tests* screen lists pre-configured tests.

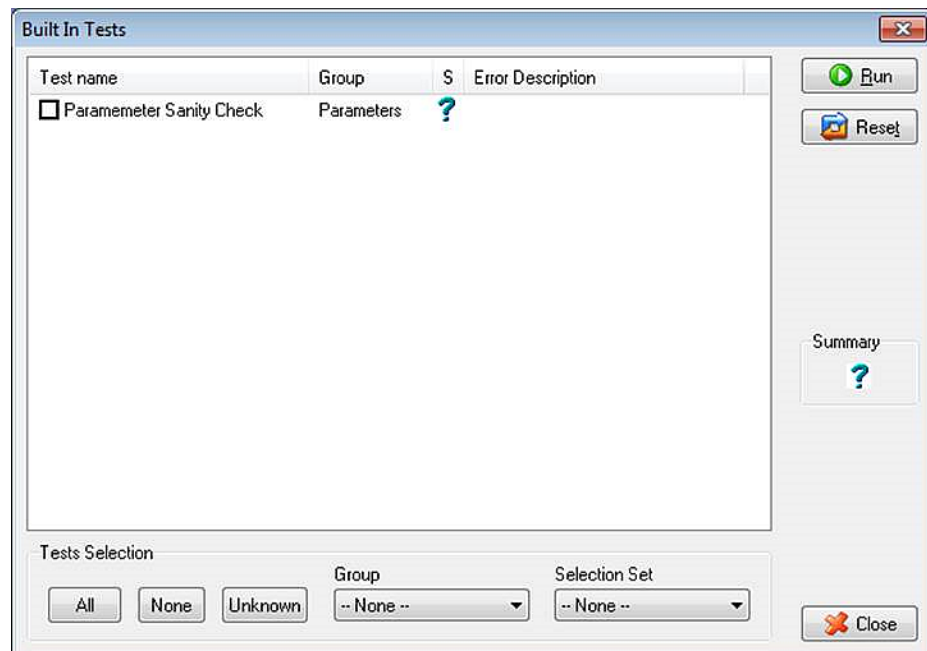



Figure 6-138 *Built In Tests* screen

## Status

The “S” column shows the results of the test after you run it:

- ✓ Test successfully completed.
- ✗ Test failed.
- ? Unknown results. (The test has not been run yet.)

To run the test:

- Select the check box and click .

After you run the test, the Save and View command buttons are added to the Built In Tests screen.



Figure 6-139 BIT command buttons

**Test Results** To save and view a report of all tests:

- Use the Save and View command buttons.

## Replacing the Waste Container

Printer waste contains partially cured polymeric material, collected during normal operation and maintenance of the printer. For safety and environmental reasons, this material is kept in a special leak-proof, disposable container.

The container has a capacity of 1.8 kilograms of waste material—usually enough for several weeks of printer use. The printer application displays a warning message when there are 1.5 kilograms of material in the container, and stops the printing when the net weight reaches 1.8 kilograms. Above 1.5 kilograms, the software does not allow you to start a printing job or activity until you replace the waste container. You can monitor the weight of the waste container in the *Maintenance* screen of the printer interface.

To monitor the waste weight (and other indicators) in the printer:

- In the main printer interface screen, click the display toggle to view the printer indicators.



Figure 6-140 Printer interface, showing waste weight (red background indicates operator alert)

The waste container consists of a sealed bag inside a cardboard box. You typically dispose of the entire waste container—including the box. Therefore, you must assemble a new box and insert a new waste bag before you can install it in the printer.



Replacement boxes, waste bags, and sealing caps are supplied in the Objet30 printer start-up kit and in the preventive-maintenance kit.

To prepare a new waste container:

1. Assemble the cardboard box, making sure to punch out the perforated sections.
2. Fold a new waste bag—so it fits in the box—and insert the bag's screw-connector into the hole in the top of the box.

**Note:** Do not close the box until you connect the waste drain tube from the printer.

To replace the waste container:

1. Open the materials drawer.
2. Remove the fireproof cover from the waste container.



Figure 6-141 Removing the waste-container cover

3. Unscrew the cap connecting the waste drain tube to the container.
4. Carefully lift out the waste container to remove it from the printer.
5. Close the full container with the cap supplied with the new waste container.
6. Place the new waste container in the materials drawer, and attach the cap connected to the drain tube.

**Important:** Hold the waste bag with one hand while attaching the waste tube. Otherwise, the bag will be twisted, and the flow of waste will be restricted.

7. Close the new waste-container box.



Figure 6-142 Waste container with drain tube attached

8. Place the fireproof cover over the waste container, making sure that the drain tube is free and not bent.



Figure 6-143 Fireproof cover installed over the waste container

**Note:** Operating the printer without the waste-container cover results in an inaccurate measurement of the waste weight, which will cause waste to overflow into the printer.

9. Close the materials drawer.



Dispose of the full waste container in accordance with environmental and safety requirements.

### Cleaning the Exterior Panels

The painted exterior plastic panels of Objet30 3D printers have a durable finish, offering excellent chemical resistance to common cleaning materials. However, it is recommended that you use only a mild soap solution for routine cleaning.

## Backing-Up and Restoring Printer Settings

Printer modes and configuration settings are stored in files on the printer computer. You can back up these files, and restore them, if necessary, using desktop icons.



Figure 6-144 *Backup and restore* desktop icons

## ReInitiate Wizard

One of the wizards listed in the *Options* menu is *ReInitiate*. You normally do **not** have to run this wizard. The process that this wizard controls runs automatically, when needed, as part of the *Pre-print* mode (before printing begins). Run this wizard only if a Stratasys Customer Support engineer instructs you to do so.

## Preventive Maintenance Tasks

Performing regular preventive maintenance improves system reliability, reduces downtime, and prolongs the life of your system. Perform the tasks listed below once a year, or every 1000 printing hours, whichever comes first.

Performing these tasks on schedule:

- improves system reliability
- reduces system downtime and costly repairs
- protects and prolongs the life of your system



The first preventive maintenance (after purchase) is performed by a Stratasys Service Engineer.

**Note:** To perform Preventive Maintenance routine, you will need the Preventive Maintenance kit. To order the Preventive Maintenance kit, contact your Stratasys service provider.

Use the following checklist to perform the preventive maintenance routine.

### Odor Filter

- Replace the odor filter.  
See "Replacing the Odor Filter" on page 6-67.

### Wiper Assembly

- Clean the area surrounding the wiper.
- Replace the wiper.  
See "Cleaning and Replacing the Wiper" on page 6-31.

### Materials Drawer

- Calibrate all the load cells.  
See "Calibrating the Load Cells" on page 6-65.
- Replace the waste container.  
See "Replacing the Waste Container" on page 6-95.

- Replace the Model and Support material filters.  
See "Replacing the Material Filter" on page 6-73.
- Replace the Model, Support and Waste material pump-tubes.  
See "Replacing the Pump Tubes" on page 6-82.

### Roller Waste Collector

- Replace the roller waste collector.  
See "Cleaning and Replacing the Roller Waste Collector " on page 6-36.

### UV Lamp

- Replace the black strip in the UV reflector.  
See "Replacing the UV Lamp" on page 6-68.
- Clean the glass lens of the UV lamp assembly with the special 3M cleaning pad.
- Clean the glass covering the UV sensor (to the right of the build tray).
- Calibrate the UV lamp intensity  
See "Testing and Calibrating the UV Lamp" on page 6-62.

### Print Heads

- Clean the print heads with the Head Cleaning Wizard  
See "Cleaning the Print Heads and the Roller" on page 6-28.
- Perform the Pattern Test  
See "Pattern Test" on page 6-33.
- Check the alignment of the print heads  
See "Aligning the Print Heads" on page 6-39.
- Run the Head Optimization Wizard  
See "Optimizing (Calibrating) Print Heads" on page 6-43.

### Printer Software

- Run a sanity check of the printer parameters  
See " Built-in Tests" on page 6-93.
- On the printer computer desktop, click **BackupData**.  
This saves a backup copy of the *Modes* and *Configs* files.
- Restart the printer and server computers.

### UV Sensor Calibration

- The UV sensor should be calibrated once every two years. If two years have passed since the last service visit, contact Stratasys to request UV sensor calibration.



# 7

## Handling Printed Models

Removing Models After Printing .....	7-2
Removing the Support Material .....	7-2
Post-Printing Treatment for Models Made with VeroClear	7-5
Photo-Bleaching Instructions .....	7-5
Storing Models .....	7-6

## Removing Models After Printing

After printing models, you should allow them to cool as much as possible before handling them. If additional models do not have to be produced on the printer, it is best to let the printed models cool in the printer, with the cover closed, as long as possible.

If the printer must be used to produce additional models as soon as possible:

1. Let the printed models cool on the build tray for at least 10 minutes.
2. Very carefully, remove the models from the tray with a scraper or spatula (supplied in the tool kit), taking care not to pry or bend the model.



### **Warning:**

Wear protective gloves when handling printed models before they are washed.

3. Place the models on a flat surface, and cover them with a cardboard box or paper hood.  
This allows the models to cool slowly and evenly.
4. Let the models cool for several hours.

## Removing the Support Material

After printed models have cooled, the support material must be removed. This can be done by different methods, depending on the type of support material, the size of the model, how delicate it is, the amount and location of the support material, and other factors. Use the following methods as a guide, and adapt them (or a combination of them) for finishing the models you are handling.

There are two types of support material available:

- SUP705 (FullCure705), a gel-like support material.
- SUP706, an easily removed support material that dissolves in a solution of caustic soda and sodium metasilicate.

SUP705 (FullCure705) and SUP706 can be removed from printed models using the following methods, in this order:

1. by hand
2. water pressure (in a suitable cleaning unit)
3. SUP705: 1% caustic soda solution (recommended for a smooth finish)  
SUP706: 2% caustic soda and sodium metasilicate solution

Removing  
Excess Support  
Material by  
Hand

While wearing protective gloves, break away excess support material on the outside of the model. For delicate models, use a toothpick, pin or small brush after dipping the model in water.

- For SUP705, after breaking away excess support material, soak the model in a 1% caustic soda solution (see "Removing SUP705 with Caustic Soda" on page 7-4).
- For SUP706, after breaking away excess support material, soak the model in a 2% caustic soda and sodium metasilicate solution (see "Removing SUP706 with Caustic Soda and Sodium Metasilicate" on the next page).

### Removing Support Material with Water Pressure

For most models, the most efficient way to remove support material is by using a high-pressure water jet. One suitable system is the Objet WaterJet cleaning unit.

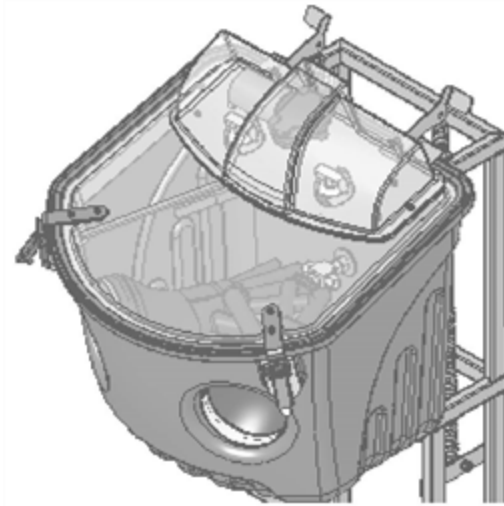

Figure 7-1 Objet WaterJet Cleaning Unit

To clean a model using this device, you place it in the chamber, and you manipulate it and the jet using the built-in, waterproof sleeves. A pump turns ordinary tap water into a high-pressure jet, and a wiper keeps the window clear.



Use caution when cleaning delicate models with high-pressure water systems.

**Removing  
SUP705 with  
Caustic Soda**

Soak models in a 1-percent solution of caustic soda (sodium hydroxide) to remove support material from difficult-to-reach areas and to give the model a smooth, clean finish. The amount of time you soak the model in the solution depends on how delicate it is and how much support material needs to be removed, but it is typically between half-an-hour and several hours. In any case, you should remove as much support material as possible before the caustic soda treatment, and rinse the model thoroughly (with a water jet) afterwards.

**Warning**

Caustic soda may cause chemical burns, scarring and blindness. Mixing it with water generates heat that could ignite other materials. Never pour water into caustic soda. When diluting the solution, always add caustic soda to water. Take adequate safety precautions; always use nitrile gloves when handling caustic soda and models soaked in it.

**Removing  
SUP706 with  
Caustic Soda  
and Sodium  
Metasilicate**

Soak models in a 2-percent solution of caustic soda (sodium hydroxide) and sodium metasilicate ( $\text{Na}_2\text{SiO}_3$ ) to remove support material. The amount of time you soak the model in the solution depends on how delicate it is and how much support material needs to be removed. Rinse the model thoroughly under running water afterwards.



SUP706 will dissolve into the caustic soda and sodium metasilicate solution and saturate it, reducing its effectiveness. Replace the solution when the Support material reaches 15% of the solution (after approximately one month of average use).

**Warning**

Caustic soda may cause chemical burns, scarring and blindness. Mixing it with water generates heat that could ignite other materials. Never pour water into caustic soda. When diluting the solution, always add caustic soda to water. Take adequate safety precautions; always use nitrile gloves when handling caustic soda and models soaked in it.

## Post-Printing Treatment for Models Made with VeroClear

Models made with VeroClear (RGD810) have a slight yellow tint when removed from the printer. This is especially true for models printed with a glossy finish. The yellow tint fades naturally over time, but you can greatly accelerate this process by using a suitable photobleaching treatment.

As a rule, best clarity is achieved when parts are printed with a matte finish, and treated as explained below.

Photobleaching models involves exposing them to light. To achieve highly controlled and predictable results, a professional illumination chamber is recommended. However, adequate results may be obtained using ordinary desk lamps fitted with suitable fluorescent elements.



Figure 7-2 **Left:** Illumination chamber; **Right:** Desk lamps

### Photo-Bleaching Instructions

Follow these instructions for photobleaching printed models.

- The fluorescent lamps should be rated 45W, 6500K.
- When using desk lamps, place the models in a container lined with aluminum foil. Use at least two lamps, more when treating models in a large container.
- Arrange the models with enough space between them to allow light to reach all sides of each model.
- Verify that the ambient temperature around the models is approximately 40°C (104°F). Higher temperatures may cause model distortion; lower temperatures may not produce satisfactory results. When using desk lamps, you can achieve the required temperature by positioning the lamps approximately 10 cm (4 in.) above the models.
- Inspect the models after six hours of treatment.
  - For parts with a matte finish, this should be enough. Polish and lacquer the parts.
  - For parts with a glossy finish, continue the photobleaching treatment for up to 18 hours more.

In Stratasys laboratories, there was a tint reduction of approximately 70% within six hours. After 24 hours, tint was reduced by approximately 90%.



More information about this treatment is available in the application note *VeroClear RGD810 Model Material*.

## Storing Models

Models are cured as they are printed, making them safe and stable for a long time. However, proper storage conditions are necessary to prevent deforming.

- Keep printed models at room temperature and in a low-humidity environment.
- Do not expose models to direct sunlight and other heat sources.