

Fusion3

Affordable High-Performance 3D Printers

Operation Guide F306 3D Printer

Revision 7 | 04-12-2016

1. Introduction.....	3
Warnings	3
2. Common Tasks	4
3. Your First Print.....	5
3.1. Inspect Your System	5
3.2. Level the Print Bed	5
3.3. Load Filament & Prepare to Print.....	5
3.4. Print!	6
3.5. After the Print.....	7
4. General Info—Software	7
4.1. Software toolchain overview	7
4.2. Simplify3D Tutorials	8
5.3. Setting up Simplify3D	8
6. General Info—Hardware.....	14
6.1. Machine Overview	14
6.2. Precautions.....	18
6.3. Filament	21
7. General Tasks	22
7.1. General Menu Information.....	22
7.2. Leveling the Bed.....	22

7.3.	Loading & Unloading Filament Spools	24
7.4.	Cleaning and Prepping the Bed	29
7.5.	Slicing and Printing a File	31
7.6.	After a Print Completes	31
8.	<i>Troubleshooting & Advanced Techniques</i>	33
8.1.	Simplify3D Guidelines	33
8.2.	First Layer Height	41
8.3.	Temperatures & Other Information	43
8.4.	Part Warp (printing large parts)	44
8.5.	Printing Small Parts	44
8.6.	Print Head & Extruder Jams	45
8.7.	Z Axis Noise.....	47
8.8.	Experimental Materials	47
8.9.	Different Print Heads.....	47
9.	<i>Maintenance</i>	48
9.1.	Extruder Idler Bar Springs	48
9.2.	Drive Cable Tension.....	50
9.3.	X Crossbar Square	52
9.4.	Z Axis Rods and Leadscrews.....	53
9.5.	Print Head.....	53
9.6.	Feed Gear	54
10.	<i>Further Support</i>	54
11.	<i>Glossary</i>	55
	<i>APPENDIX A: Unpacking & Setup</i>	56
	<i>APPENDIX B: High-Precision Flow Rate Calibration</i>	63
	Step 1: Measure Filament Diameter	63
	Step 2: Prepare test object	64
	Step 3: Measure wall thickness.....	65
	<i>APPENDIX C: Notes for Dual Extrusion Owners</i>	67
	Operational Changes.....	69

1. Introduction

Thank you for purchasing Fusion3's F306 3D printer!

This manual is designed to familiarize you with your F306 and its use and give you the tools to get the most out of your new printer. The F306 has been engineered for many years of trouble-free operation and outstanding output quality.

Warnings

Your F306 contains parts that reach high temperatures during operation. Specifically, the print head and the print bed get very hot. Do not to touch these components while the F306 is in operation or while they are at an elevated temperature (see Front View figure below).



While we have carefully designed your F306 to operate in a safe manner, accidents can happen. **Your F306 should NEVER be allowed to run unattended or overnight.**

Your F306 contains components that operate at 110VAC. These components have been shielded to prevent accidental access. The guards are marked with the warning below and shall **NOT** be removed while your machine is in operation, or plugged into the wall.



Your F306 also contains components that pose a pinch hazard while in operation, such as the linear motion carriages and the extruder feed system. Take care to keep fingers, hair, other body parts, and clothing away from these components while your F306 is in operation.



Your F306 is a high-precision piece of equipment that is precisely constructed, aligned, and calibrated at our factory. Refrain from subjecting your printer to shocks, drops, or heavy forces that may cause misalignment of the components.

2. Common Tasks

Topic	How To	Reference
Glue Stick	Use only Elmer's "purple disappearing" glue. If you are unable to find this, Avery Disappearing Color Glue Stick is an acceptable alternative. Put down thin, even Layers with no gaps between them. Apply one layer for PLA. Apply two layers at right angles for ABS.	Section 4.3, 7.4
Cleaning the print bed	Use only water, your scraper and paper towels. Mist the entire bed until all of the glue is uniformly purple. Use the scraper to "pile" the glue up making it easier to wipe. After scraping the glue to one side, wipe it with the paper towel. Then mist the bed again and wipe with another paper towel. Use gentle pressure and never push down on the print bed with anything. Clean the bed thoroughly after every print. ALWAYS apply fresh glue for each print. After the printing cycle, the glue's chemical properties change and it loses some of its adhesive capabilities.	Section 7.4
Adjusting & leveling the print bed	Make sure the print head is free of filament before you start the leveling process. Do not scrape the filament off the print head. Heat the head and wipe it gently with a clean paper towel folded over several times so you don't burn your fingers (section 6.6). Never force the feeler gauge under the print nozzle - you can damage the nozzle tip. Gently press down slightly on the glass near where you are measuring the gap between the nozzle and the bed, then release the glass and adjust the gap to the proper size.	Section 7.2
Moving the bed and print head by hand	Always have the printer powered on when moving parts by hand , using gentle and even motion to do so. To move the Z-axis, always use the belt. DO NOT push on the bed to move it up and down.	Section 6.2
Loading & Unloading filament	Follow the specified procedures for loading and unloading filament. Your F396 has automated tools to simplify these procedures.	Section 7.3
Inexpensive and discount filament	Use approved filament providers and keep filament in sealed bags with desiccant when not in use. Be suspicious of inexpensive filament. The quality of the base material, the quality and type of colorizing agents and whether or not the filament has been protected from moisture all have a large impact on how well it will print. Use of poor quality filament may void your warranty – only use the filament suppliers listed on our website.	Section 6.3
Removing your print	PLA - remove with gentle twisting motion. Do not force. For stubborn parts heat the bed to 70°C. Gently wedge scraper under a corner to lift the part. Turn the bed heater off when part is removed. ABS - self releases when the bed cools down to about 50°C. You will hear a "pop" when they release. Nylon - hold the scraper at a fairly "flat" angle and gently work it under the part.	Section 7.6

Getting the 1st layer right	The first layer is the most critical step when it comes to achieving consistent high quality prints. See the pictures in this section.	Section 8.2
Periodic maintenance	Periodically, you should verify everything listed in Section 9.	Section 9
Dual print head information	Dual head printers are more complicated and some functions are different than described in the manual. Please read Appendix C .	Appendix C

3. Your First Print

This section will guide you through the steps to get your F306 printing for the first time. We highly recommend using the included roll of PLA filament, and printing the pre prepared file on your SD card. These instructions will walk you through how to accomplish this.

3.1. Inspect Your System

If you had your F306 system shipped to you, see Appendix A - Unpacking & Setup for inspection instructions. If anything has been damaged in shipping, it's important to catch it now before it might damage something else!

3.2. Level the Print Bed

See section 7.2 for instructions on how to level the print bed. Out of the box, this is merely an inspection to verify nothing has changed during shipment. There shouldn't be any adjustments required. If there are any major changes necessary, it could be an indication that the printer was jarred during transport from our facility to yours.

3.3. Load Filament & Prepare to Print

Every F306 comes with a free roll of high quality PLA. We **highly** recommend using this included material for your first print. Not only is PLA an easy material to work with, but your SD card includes a pre prepared print file that is configured to be printed using PLA.

Load the filament into your F306 using the "Load filament" script in the "Prepare" menu. See section 5.3 for more information.

Next, prepare the print bed for printing.

Fill the included spray bottle with normal tap water. If the print surface is dirty, use the spray bottle and paper towels to clean it. **DO NOT** use cleaners such as Windex, acetone, or rubbing alcohol to clean the print surface. Using these chemicals can cause print adhesion problems. Use **light hand pressure** when cleaning the bed. You should never push down on the print bed as that may misalign it. **Always** look at the bed corner clips after cleaning the bed. It is possible that the clip can be wedged down among the threads of the bolt, preventing the bed from sitting at its correct position (see figure). If this happens and is not caught, the first layer will be too far and adjusting the corner clips without making sure the bed is properly seated in the corner clip to correct this will cause future prints to be way too close, should the clip ever become "unstuck" from the threads. In this situation, the bed would be so tight against the nozzle that the filament will not even come out and the extruder will begin to chew into the filament, making an audible "click" every two seconds or so. If this happens, reset the printer, lower the bed and manually feed filament to verify it is not an actual jam in the nozzle. Reverse the extruder by $\frac{1}{4}$ turn. Inspect bed once again.

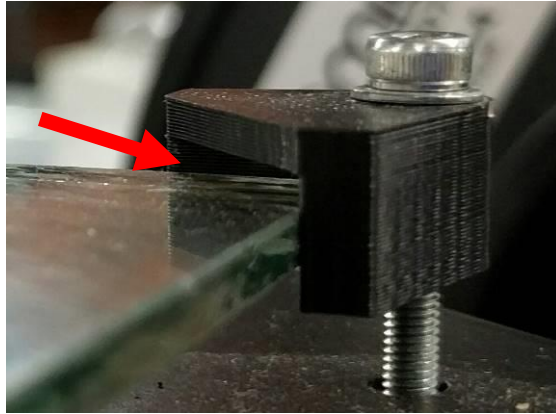

Figure 1: Print bed not correctly seated in corner clip

Once the print surface is clean and dry, apply the included purple gluestick. Hold the stick vertically and wipe back and forth to apply a single, light, even layer of glue to the bed. Each pass should slightly overlap the previous pass, preventing any gaps between passes. Since this is a small part we don't need to coat the entire surface, just a roughly 6 inch by 6 inch section in the center of the bed. See section 7.4 for more information.

A note on glue application: In addition to putting glue in the area the part will print, also put a 6 inch long glue "stripe" where the nozzle "wipes" at the beginning of every print. This will help the plastic that is extruded before the print starts to stick and not drag into the part area. Also note that **PLA only needs a single thin layer of glue, but ABS needs 2 thin layers put on at right angles to each other.**

3.4.Print!

Now, we're ready to print! Navigate to the "Card Menu" on the control panel and select the "getting started prints" folder. You should see one file called "Twisted_Bottle_PLA.gcode" (the file name might be truncated.) "Press" to select it, and your F306 will automatically begin the print!

First, your printer will move all three axes towards their minimum positions until it touches the limit switches. This is called "homing the axes" and is how your F306 knows where it is in 3D space.

While it's homing, it will begin heating the print bed to the correct temperature for PLA (45°C.) You should see the temperature climbing on the control panel.

Once all three axes are homed, your F306 will finish heating the bed. Then it will begin heating the print head to the correct temperature for PLA (205-215°C.) The print head will take 2-3 minutes to come up to temperature and stabilize. It's normal for the temperature to oscillate around the set point 2-3 degrees before it begins to print.

Once both the head and bed are up to temperature, your F306 will begin the print by dropping the bed about 10mm. It will then pump out about 30mm of filament. This is to ensure the melt chamber in the print head is completely filled with plastic before beginning the print. Then, the print head will move over and the table will rise back to the 0 point. The print head will perform a rapid "wipe" move to the right, in order to wipe the purged filament off of the head.

The print head will move to the center of the bed and begin to print your object! First, it will draw an outline around the part called a "skirt." This is a single extrusion bead offset from the part by about 5mm. The main purpose of this is to stabilize the flow rate of plastic before beginning the actual part. It also allows you to make sure the height of the first layer is correct, and that the material is laying down correctly.

After the skirt is complete, it will start printing the actual part. The first layer is always done at about 40% of normal print speed, to ensure the material bonds to the print bed correctly. Your F306 builds parts by tracing an outline around the perimeter of the part then filling the rest of the cross section with a zig-zag infill. The 3 top and bottom layers are solid and the rest of the interior is a mostly hollow lattice (all of these settings are adjustable in Simplify3D.)

After the first layer of both pieces is complete, your printer will speed up to the default printing speed of 100mm/s for the rest of the part. The twisted bottle is a 2-piece print (body and top.) It should take about 30 minutes to finish.

3.5. After the Print

After your F306 is finished building the part, the head will move to the back left corner, the extruder will reverse 6mm and the print bed will drop to the bottom of the machine. You may then remove the parts!

- For PLA, you should be able to pop small parts off easily by hand. Large parts may need to heat the table to 70°C in order to make them easier to release by sliding the included part scraper under the part. Hold it at a slight angle and push it under the part. It's easiest to start at a corner on the printed part.
- For ABS, wait for the table to cool to ~50°C and the parts should self-release (sometimes accompanied by a loud "pop.")

You should be able to thread the top and body of the printed bottle together. The fit may be very tight at first, but will loosen up as you thread it back and forth. Also, be sure the top doesn't cross thread the first couple times you assemble it.

Congratulations! You've finished your first print on your F306!

As a final step, remove the skirt and priming pile of filament from the print bed. Remove the used glues from the bed using the spray bottle to wet it down with water. A paper towel or two will finish the cleanup. Again, it is optional to scrape a single layer application of glue. It comes off fairly easily with single motion wipes with a paper towel. ABS, however, needs to be scraped first. **Remember, use only water to clean your print bed!**

4. General Info—Software

4.1. Software toolchain overview

The job of the software toolchain is to convert a 3D model file into a list of commands that the F306 will follow to build the object. The central piece of software in this process is called the **slicer**. We've selected **Simplify3D Creator** because it combines excellent usability with a powerful, intelligent slicing engine. A 2-seat license to Simplify is included with your F306. We do not provide technical support for other slicers.

The basic steps of the slicing and printing process are shown below:

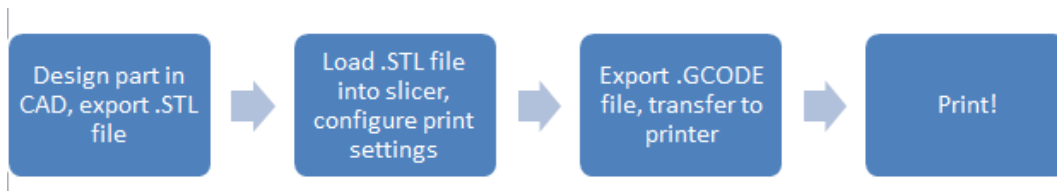

Figure 2: Slicing & Printing Workflow

4.2. Simplify3D Tutorials

Simplify 3D has provided tutorials to cover operation of their software:

<http://www.simplify3d.com/support/tutorials/>

When your printer was shipping, an email with license information for Simplify was sent from Fusion3 to the contact person listed in the order for your printer. This email included a Simplify guide and described the process for getting your license activated.

5.3. Setting up Simplify3D

Step 1: Set up your Account

With version 3+ of their software, Simplify introduced a new license management system that makes it easier to see where your copies of Simplify are registered. You will need to create a user account and associate your license key with your email and username.

There will be a link to set up your account in the email from Simplify. Please click on that link and follow the instructions for setting up your account. Then, you will be able to access your Simplify3D Dashboard. You will find “Downloads” in the left hand menu.

For additional information see [this video](#).

Step 2: Download & Install

First, we recommend you uninstall any old versions of Simplify to avoid confusion.

Downloading and installing works the same: download the executable from your account page, and run it once it's finished downloading. The installation process is straightforward and remains the same.

Step 3: Copy Configuration Files to Hard Drive

You will also need to copy the configuration files (.FFF files) from your SD card to your hard drive. We recommend creating a folder in your “My Documents” folder for them.

If you've downloaded them from our site, you'll need to extract them from the zip file using software such as WinRAR or 7-zip, instead of copying them from the SD card.

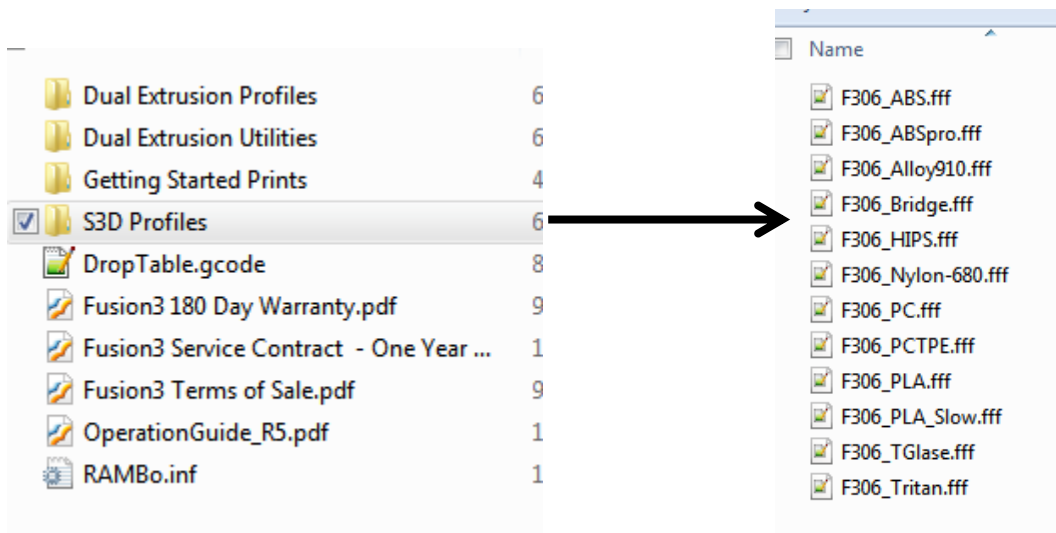

Step 4: First Run & Setup

The first time you run the software, it will prompt you for your username and password. You will need to enter the credentials you created in step 1. The software will “phone home” to assign a license key to your installation. You will need to be connected to the internet for this first run. After this initial activation, the software may be run without an active internet connection.

You’ll then see a setup wizard similar to previous versions of Simplify.

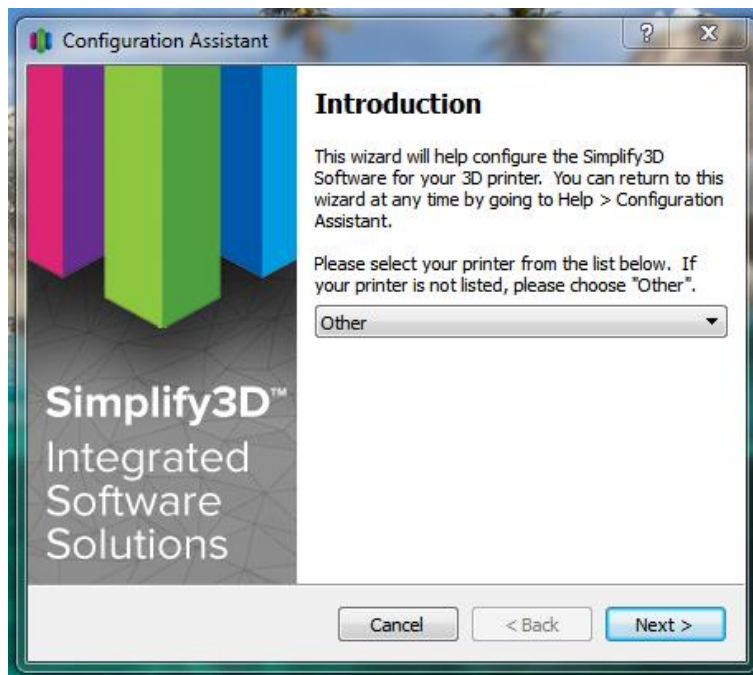

On the introduction page, select “Other” in the drop-down as shown above.

IMPORTANT: Use the Simplify profiles provided by Fusion3. DO NOT use the F306 profiles built into Simplify! Several customers have reported issues with these profiles not being set up correctly.

Click "Next."

The next page does not matter, as any settings created here will be over-written when we import the F306 profiles. You can leave the defaults and click "Next".

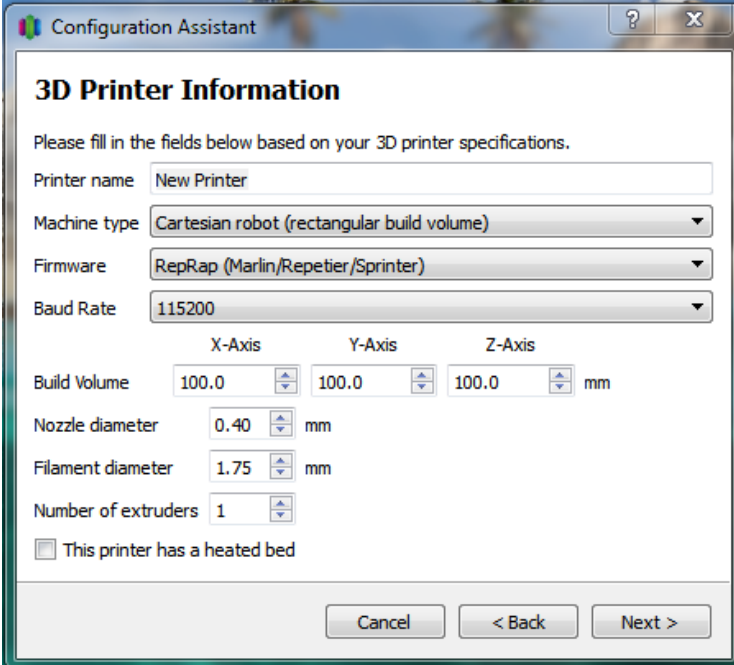

The screenshot shows a window titled "Configuration Assistant" with a "3D Printer Information" section. Below the title is a prompt: "Please fill in the fields below based on your 3D printer specifications." The fields are: "Printer name" (text input with "New Printer"), "Machine type" (dropdown menu with "Cartesian robot (rectangular build volume)"), "Firmware" (dropdown menu with "RepRap (Marlin/Repetier/Sprinter)"), and "Baud Rate" (dropdown menu with "115200"). Below these are "Build Volume" settings for X-Axis (100.0), Y-Axis (100.0), and Z-Axis (100.0) in mm. "Nozzle diameter" is 0.40 mm, "Filament diameter" is 1.75 mm, and "Number of extruders" is 1. There is a checkbox for "This printer has a heated bed" which is unchecked. At the bottom are "Cancel", "< Back", and "Next >" buttons.

Click "Finish."

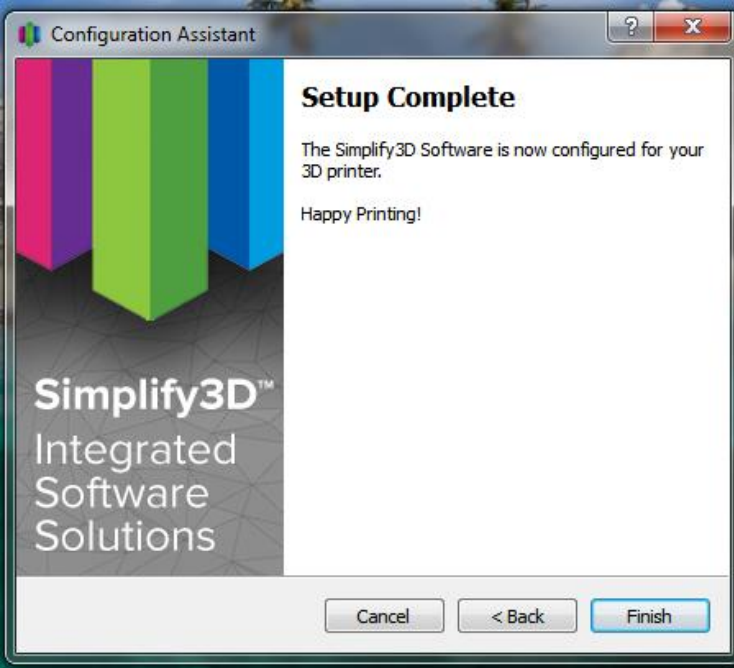

The screenshot shows the same "Configuration Assistant" window, but now displaying "Setup Complete". The text reads: "The Simplify3D Software is now configured for your 3D printer. Happy Printing!". On the left side, there is a graphic with four vertical bars in pink, purple, green, and blue, and the text "Simplify3D™ Integrated Software Solutions". At the bottom are "Cancel", "< Back", and "Finish" buttons.

Simplify will now open.

The first thing we need to do is to import the configurations for your F306. Go to “File > Import FFF Profile”.

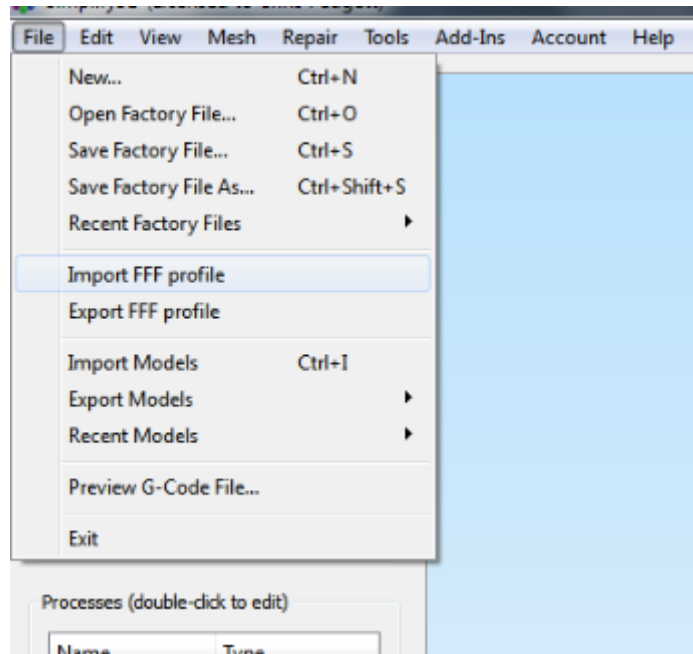

In the dialog box that appears, navigate to the location on your hard drive where you extracted the configuration files in step 3. Select all the profiles you wish to import and click “OK.”

Note: you may import multiple files at once.

You’ll get a popup saying import was successful.

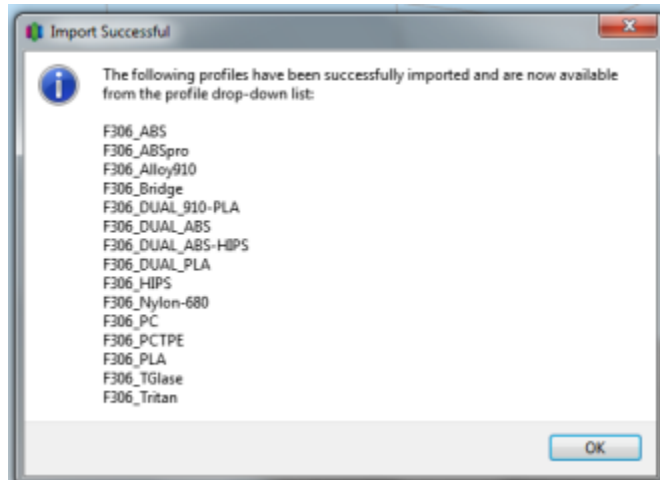

Note: Dual extrusion users will also need to repeat this process for the configurations in the “Dual Extrusion Profiles” folder.

Next, we’ll need to remove the “new printer” preset from the list since it’s not set up correctly.

In the bottom left section of the application, click “Add.” A dialog box with various settings will appear.

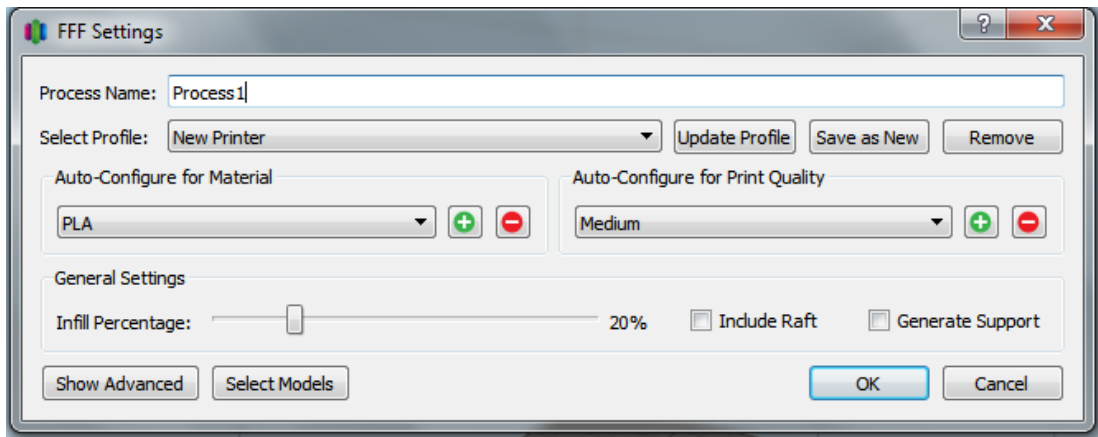
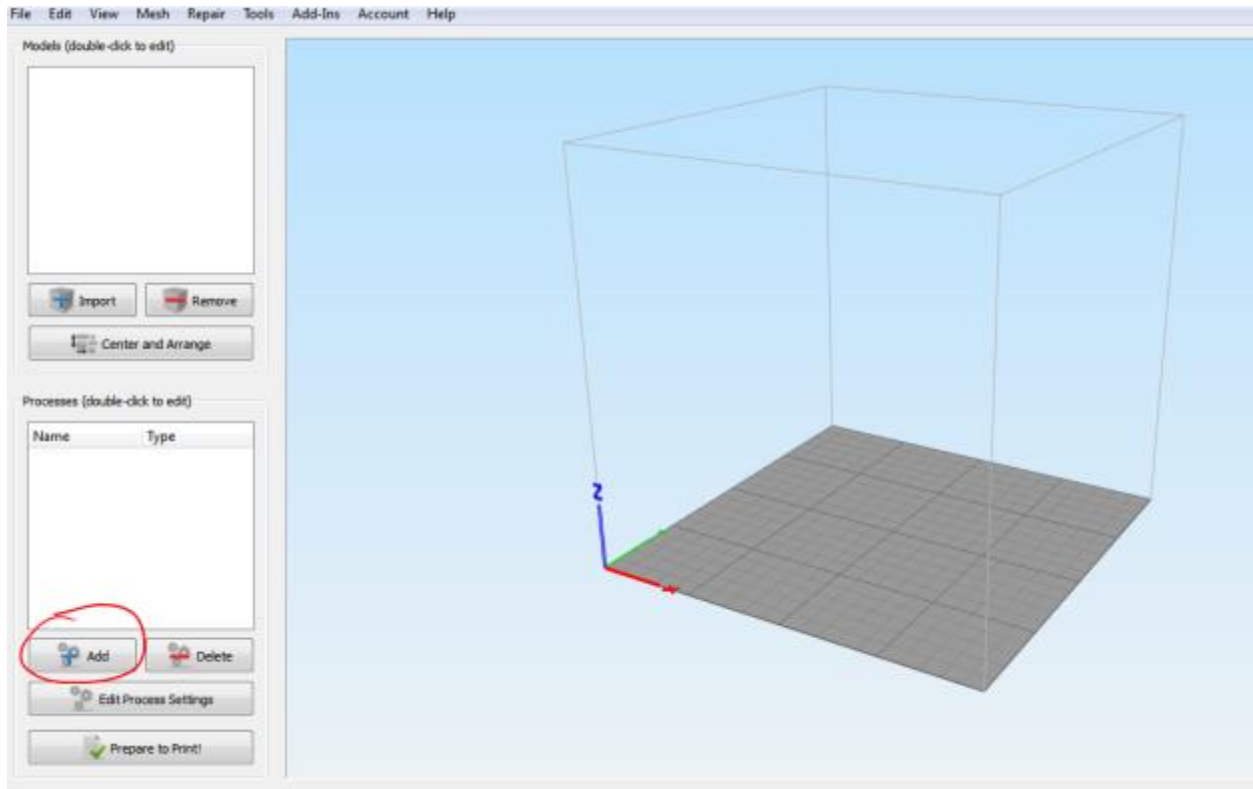

Click the drop-down menu next to "Select Profile." You should see a profile titled "Default," a profile titled "New Printer" and all of the profiles you just imported.

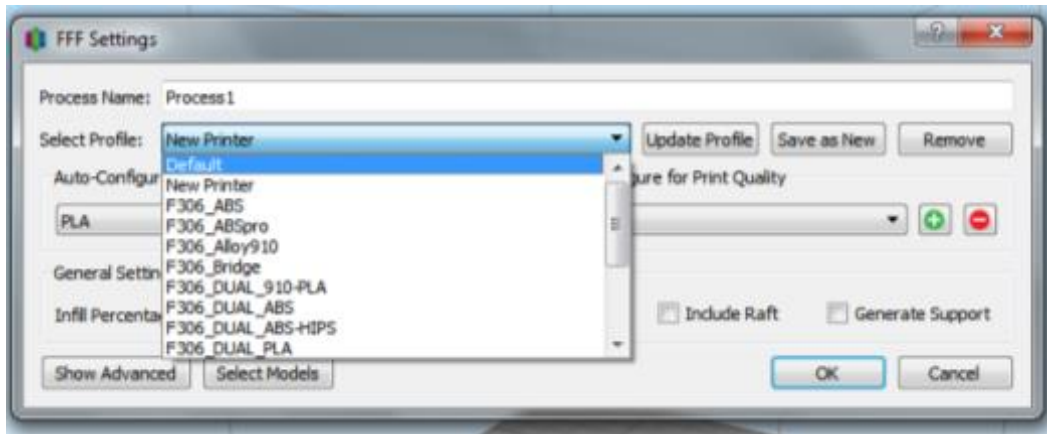

Select the “New Printer” profile and then click the “Remove” button to the right. A small window will pop up. Make sure the “New Printer” profile is the only one selected (you can select multiple at once) and click “OK.”

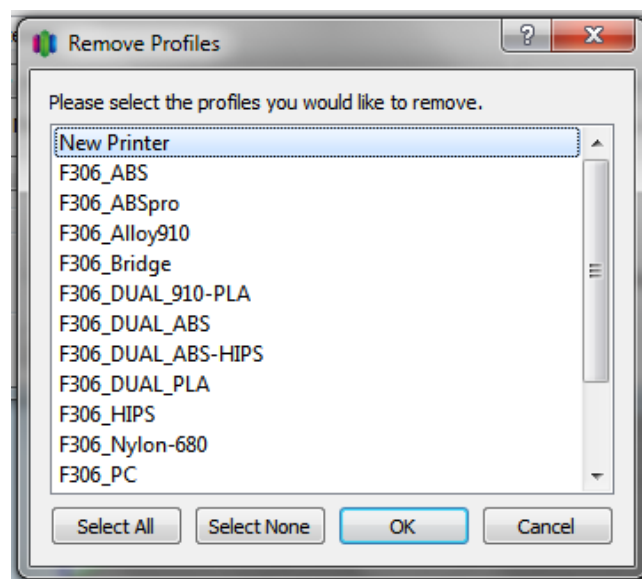

Note: the “Default” process cannot be removed.

Now Simplify is set up correctly for your printer!

Additional Information About Simplify3D:

- Managing printer profiles: <https://www.youtube.com/watch?v=eZ7HFPY1wog>
- V3 FAQs: <https://www.simplify3d.com/support/version-3-0-faqs/>
- V3 release notes: <https://www.simplify3d.com/software/changelog/>
- Simplify Tutorials: <https://www.simplify3d.com/support/tutorials/>

Where Can I Get Models to Print?

If you don't want to design your own parts, there are many sites on the Internet with freely available models designed for 3D printing. Here's a partial list:

- <http://www.thingiverse.com/>
- <https://www.youmagine.com/>

- <http://repables.com>
- <https://cubehero.com/>

6. General Info—Hardware

6.1. Machine Overview

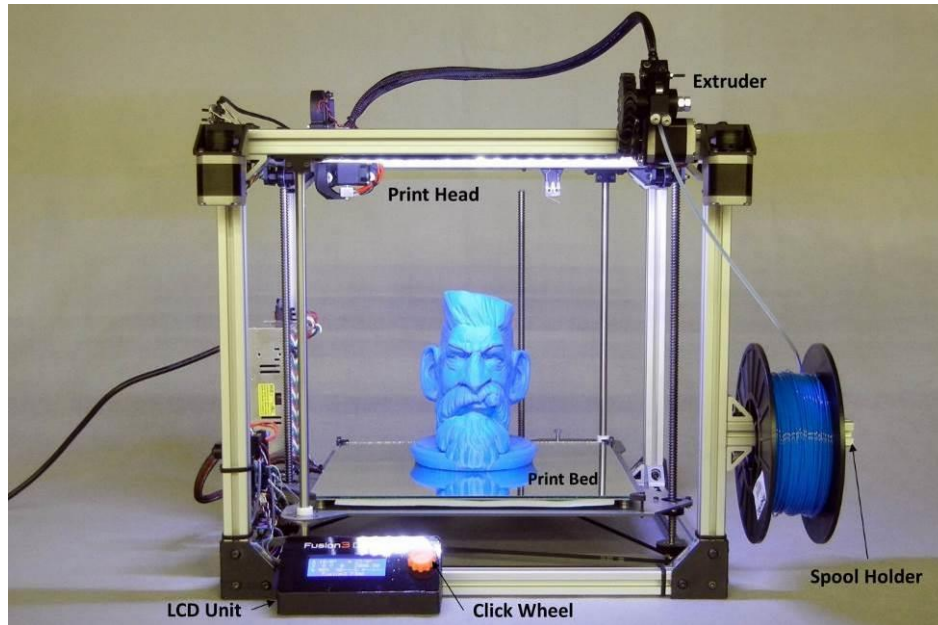

Figure 3: Front View

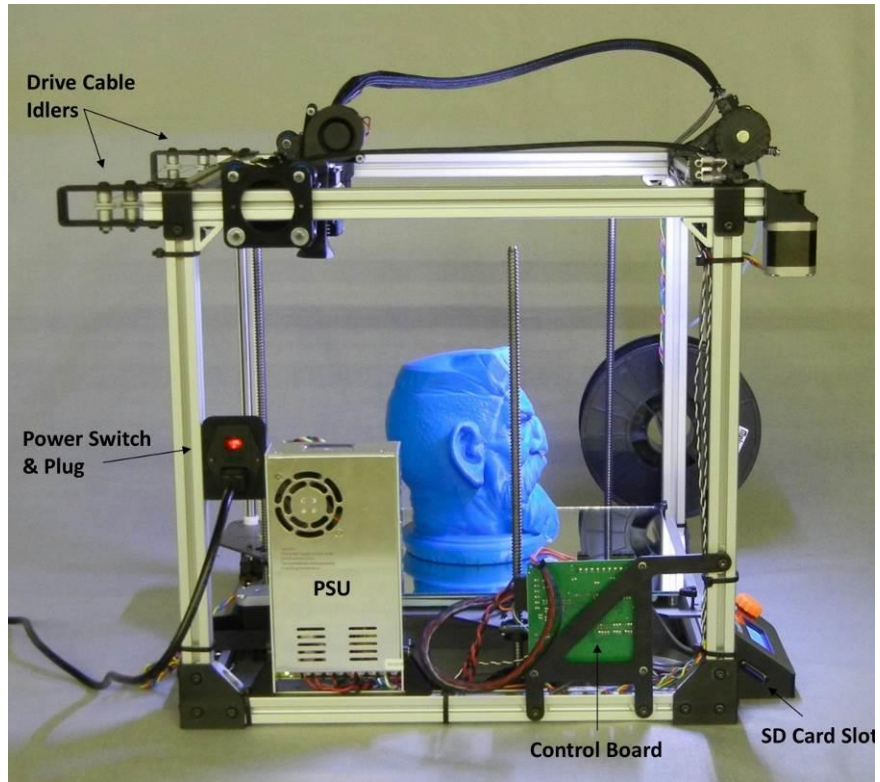

Figure 4: Side View

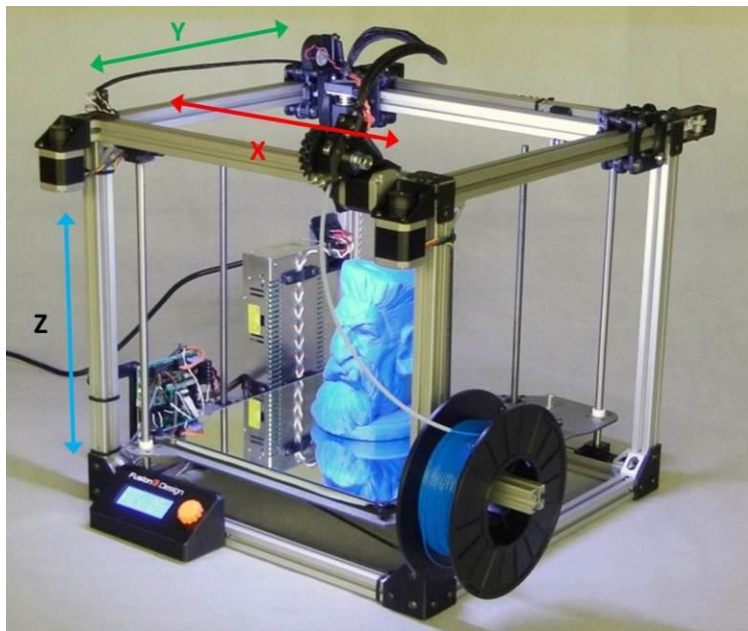

Figure 5: Axes Layout

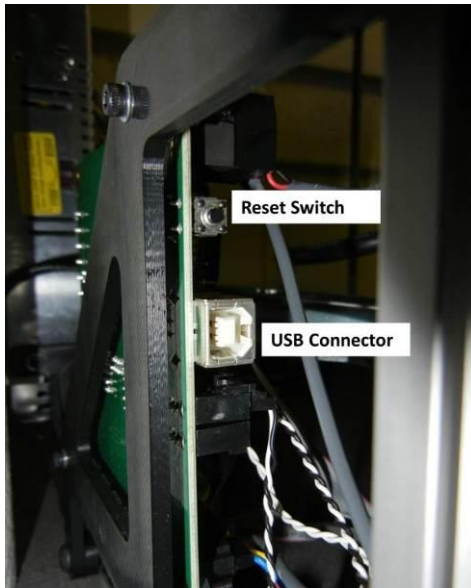

Figure 6: Control Board Detail

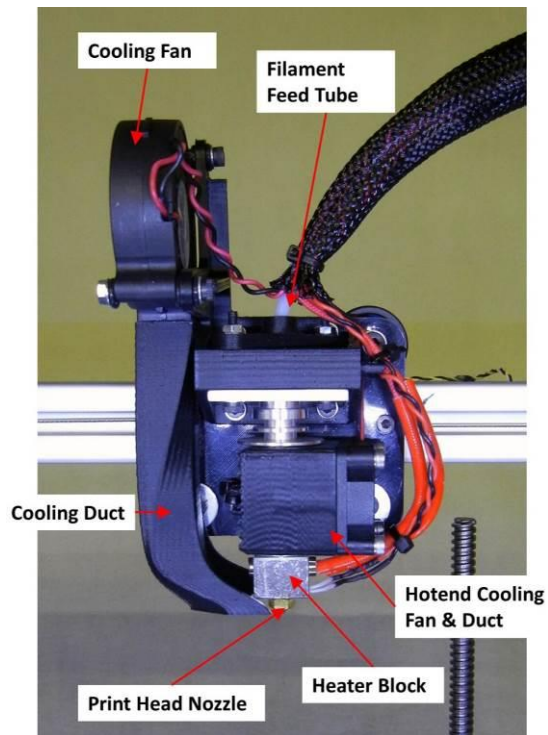

Figure 7: Print Head Detail

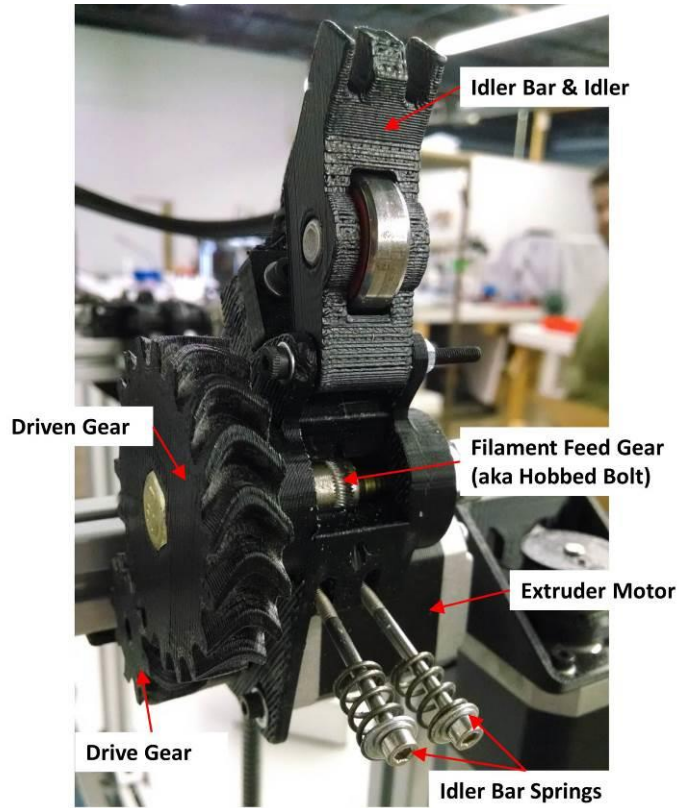

Figure 8: Extruder Cold End Detail (your extruder may look different than this-there are several versions in use on the F306)



Figure 9: Control Panel

1. Print head current temperature
2. Print head set point (0 means the heater is off)
3. Heat bed current temperature and set point

4. Print head position in XYZ space
5. Feed rate (turning this knob will increase or decrease the print speed in real time)
6. Indicates % complete while a print is running
7. Print elapsed time
8. Message row

6.2. Precautions

Moving Components By Hand

If you need to move the print head, X crossbar, or Z axis by hand, **only do this with your F306 powered ON**, but the stepper motors disabled (Prepare -> Disable Motors or simply press the reset switch.) Move components gently and do not move them too quickly.

Particularly on the print head, do not use the cooling fan as a grab point. The proper method is to grasp the sides of the carriage with your fingers as shown.

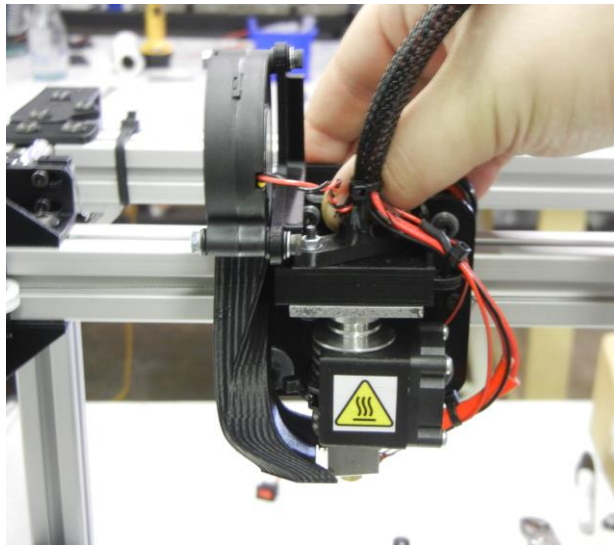

Figure 10: Print Head Recommended Grab Points

On the Z axis, use the toothed belt to move the platform up or down. **DO NOT attempt to move the Z axis by pushing or pulling on the platform directly.** When moving the Z axis up, take care that you don't move it too far and collide with the print head. This can damage the print surface, the print head and cause misalignment.

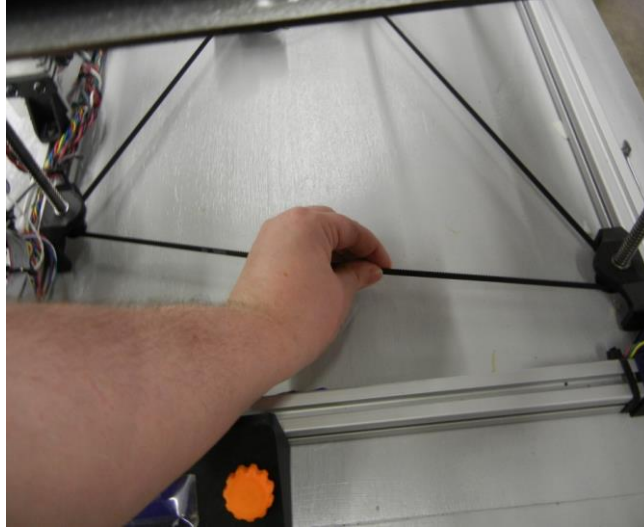

Figure 11: Moving the Z Axis by Hand

IMPORTANT: DO NOT move any part of the machine while it is powered completely off. When powered off the motors will act as generators and cause electricity to be generated in the electronics, and this may damage the control board.

Cleaning the Print Bed

Do not use cleaners such as glass cleaner, acetone or mineral spirits to clean the print bed. These will leave a residue on the print bed and adversely impact print adhesion. **Only use water to clean the print bed.**

Lifting and Carrying

To move your F306, position the print head and crossbar at the rear of the machine (remember, move them slowly by hand) and position the print bed at the bottom of its travel. Use the “Drop Table” file on your provided SD card. Grasp the machine by the Y bars as shown and carefully lift the machine up. Take care not to catch the control panel on you as you lift.

Optionally, you can remove the control panel from the printer for transport. This eliminates the chance of inadvertent damage.

If you are going to be carrying your F306 through a doorway, we recommend folding the spool holder against the frame. To do this, loosen the 2 bolts that hold the holder in the brackets, and fold it back. Re-tighten the bolts to keep it in place.



Figure 12: Proper Lifting Technique

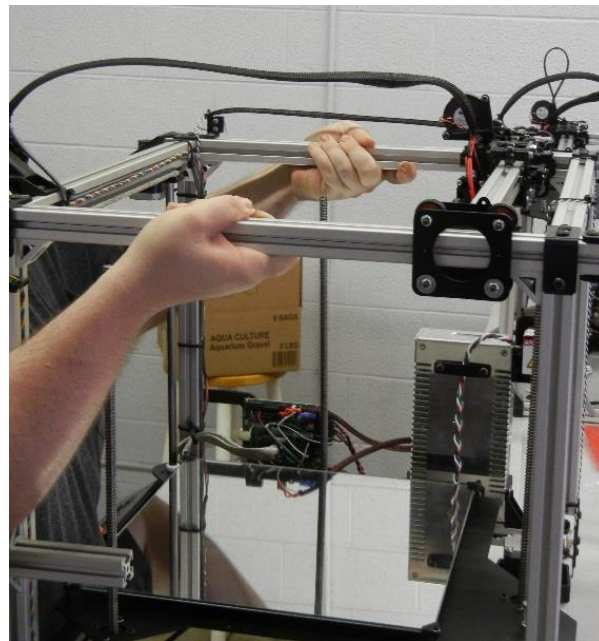

Figure 13: Proper Grab Points Detail

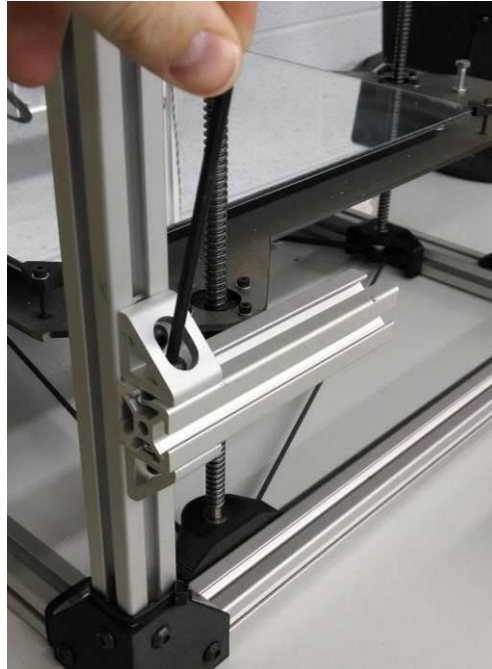

Figure 14: Spool Holder Folded In

6.3.Filament

Quality Matters

Fusion3 has tested filament from multiple suppliers around the globe. The quality of the filament matters a surprising amount. Even with an excellent 3D printer, poor quality filament results in poor quality parts. As a result we've worked hard to locate and partner with top-tier suppliers.

Where to Buy?

Our belief is that people should be free to choose from a variety of sources when they buy their filament. For that reason, we made the F306 compatible with a wide range of material types and spool shapes and sizes. You do not have to buy filament from us!

You should purchase your filament from one of our approved suppliers. Suppliers on this list have been extensively tested by us, and deliver high quality, consistent filament that works well in your F306. An up-to-date list of approved suppliers can be found on our website at http://www.fusion3design.com/3d_printer_filament/ **Use of filament from other suppliers may void your warranty!**

Material Compatibility

Thanks to its all-metal print head and high-temperature heated bed, your F306 is capable of printing nearly every 3D printer filament available on the market. There are nearly 100 materials currently available, and we simply don't have time to test them all and develop settings for them.

In order to successfully print a material, a .FFF configuration, often referred to as a profile, needs to be generated for that material. This profile is loaded into Simplify and tells the software how to work with that material.

We include profiles for common materials (PLA, ABS, Nylon, etc.) with your F306.

If there is a specific material you'd like to use, please email us at support@fusion3design.com. We may have a profile we can share, or we'll add that material to our "to be tested" list and generate a profile for it.

7. General Tasks

7.1. General Menu Information

The LCD screen attached to your F306 contains a set of menus that allow you to perform all of the functions needed to run your printer. For instance, you may load and unload filament, home the axes, and set the temperatures of the print head and bed.

Navigate through the menus using the scroll wheel. Turning the wheel left or right will scroll through the menu entries, and pressing the scroll wheel in will select the highlighted entry. Spend some time scrolling through the menu to familiarize yourself with how it works and where to find particular functions. Note that when you press the scroll wheel on some items a sub-menu will appear to make the selections related to that item.

Menu Structure:

- Prepare
 - Disable Motors (de-powers stepper motors)
 - Home All Axes (homes machine to 0,0,0)
 - Home Z axis (homes only the z axis and leaves only Z motor energized – used for leveling the bed)
 - Load Filament (script for loading filament into extruder)
 - Unload filament (script for unloading filament from extruder)
 - Disable Heaters (turns off print head and bed heaters, if running)
- Control
 - Temperature
 - Nozzle (sets nozzle temperature)
 - Bed (sets bed temperature)
 - Fan speed (controls speed of cooling fan, 255=max power)
 - Other settings on this menu should be ignored
 - Motion (should ignore this menu)
- Card Menu (shows list of all .gcode files and folders on SD card)
- Tune (only shown during prints)
 - Speed (adjust speed of printer during print)
 - Nozzle (adjust nozzle temperature)
 - Bed (adjust bed temperature)
 - Fan speed (adjust fan speed)
 - Flow (adjust flow rate of plastic in real time)
- Pause Print (during print) (pauses print until resumed by user; heaters are left on)
- Stop Print (during print) (stops print, heaters are left on – run the "disable heaters" command next)

7.2. Leveling the Bed

Making sure there is a correct and consistent gap between the print head and the bed is known as "leveling the print bed." This is a *very* important step to get consistent high-quality prints and good bed adhesion. We've designed the F306 to be easy to level and to hold this calibration well, so you should not have to perform this procedure often.

Video of leveling the print bed: <https://www.youtube.com/watch?v=tQIVLfrwclE>

First, make sure the tip of the print head is **completely** free of debris and plastic. If necessary, heat the print head to $\sim 200^{\circ}\text{C}$ and gently wipe it clean with a dry paper towel. Allow it to cool to less than 50°C before continuing.

Never scrape the print head with a hard object!

Second, on the control panel navigate to "Prepare" > "Home Z axis." This will home **only** the z axis and leave the motor energized, holding "Z" in place while you perform the leveling procedure.

Manually move the print head to the front left corner. Position the tip of the nozzle as close to directly over the spring as possible.

Use the 0.006" feeler gauge (provided in your toolkit) to check the gap between the print head and glass at the front left corner. You want to feel very slight drag as you gently move the gauge under the nozzle. Be careful that you are not lifting up on the feeler gauge when making this measurement because this can cause inaccurate measurements. **Never force the feeler gauge under the print head.** If the gauge doesn't fit, run the bolt in to lower the bed, allowing the gauge enough clearance. Slowly back the bolt out until you feel the slight resistance. The nozzle should not audibly pop against the glass as you slide the gauge out from under it. If this happens, it is still too close.

Use the 2.5mm ball-end hex wrench to turn the bolts.

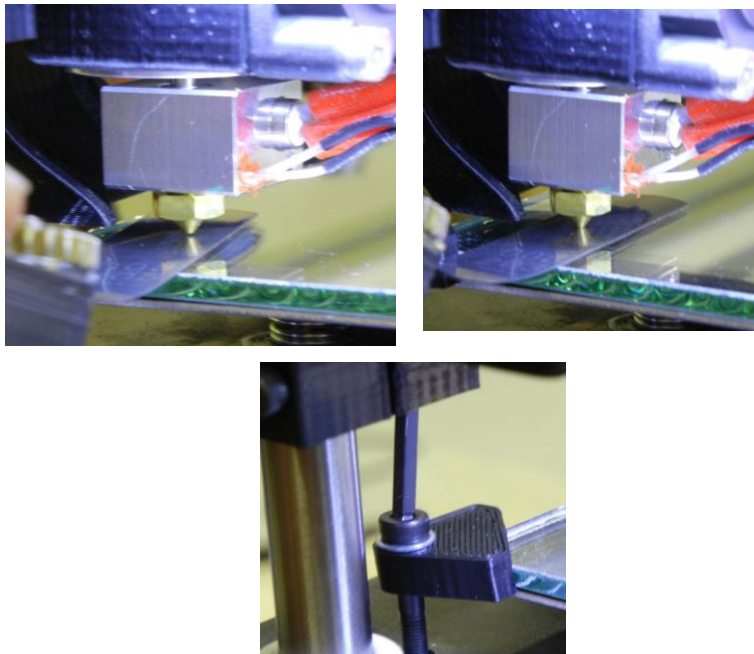

Figure 15: Leveling the Print Bed

If you lose your feeler gauge, let us know (support@fusion3design.com) and we'll mail you another one.) If you have misplaced your feeler gauge, a piece of paper folded over 1 or more times can work. Check the thickness with calipers, if you have them, and adjust the number of folds until the total thickness is .006"-.007" (since paper can compress under the nozzle). You may also need to try different weights of paper to get the right thickness.

With the front left corner adjusted, manually move the print head to the other 3 corners and adjust the height of each corner. Then, check the front left corner again to ensure it's still within spec. It is helpful to check each corner multiple times, as moving one clip will change measurements across the bed. At each corner, make sure the nozzle is directly over the spring or as close as you can get it to the spring. If you have to move the head to access the corner bolt, make sure you move the head back to the same spot to re-check the gap.

When you've finished leveling the bed, navigate to "Prepare" > "Disable motors" to de-power the z axis motor. The bed may drop slightly when the motor is turned off; this is normal.

As you gain experience with your F306, you may find that you need to tweak the gap to slightly larger or smaller than described here to get optimal first layers, especially as you change materials.

Note: With the bed cold, it is normal for the center of the bed to have a smaller gap than the corners. Your F306 has been designed so that when the bed heater is on, this center gap will be the correct distance.

Important: The small pressure switch mounted to the upper rear rail is the end-stop trigger. **Do not adjust this Z endstop trigger.** This is set at the factory to the correct distance from the bed and should not be adjusted by the end user.

7.3. Loading & Unloading Filament Spools

Loading Filament

First, trim the end of the filament to remove any previously melted plastic, or any bends. It can help to trim the end at an angle, as shown. This will help the end feed through the extruder system more easily.

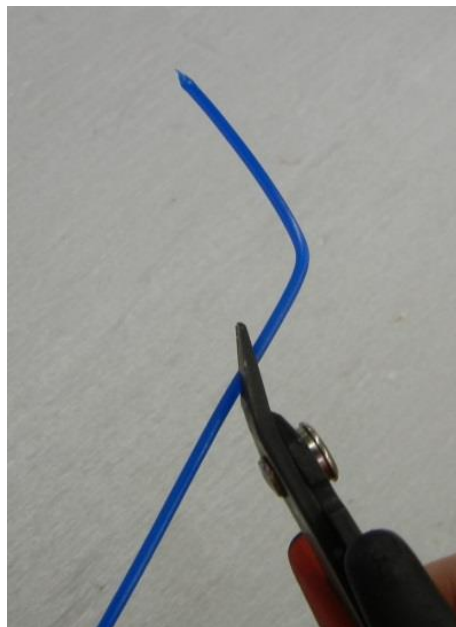

Figure 16: Trim the End of the Filament

Install the filament spool onto the spool holder so that the filament pays off from the front of the spool. On the extruder body, pull the springs down off of the idler bar. The bolts will pivot down. Lift the idler bar up so that you can see the feed gear. Now is a good time to check for debris! If you see debris, use the provided toothbrush to gently remove it.

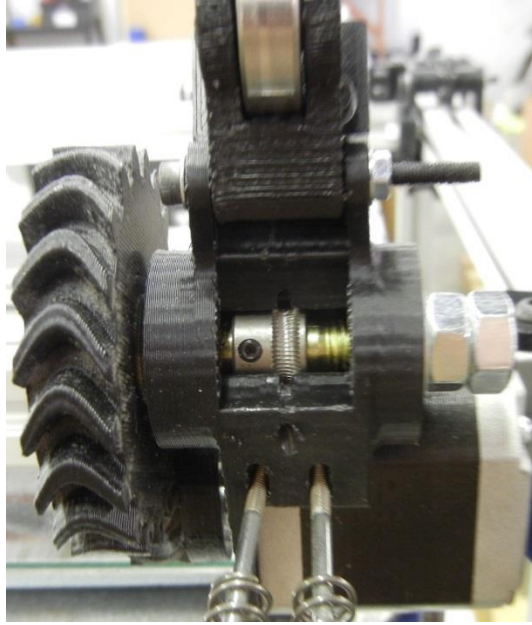

Figure 17: Extruder Ready for Loading Filament

NOTE: Some older machines do not have firmware equipped with the filament loading and unloading scripts. These users should use the manual load procedure described below.

Automatic Loading: Navigate to the “prepare” menu and select the “load filament” option. The print head will begin heating and you will see instructions on-screen to load the filament into the extruder.

Manual Loading: Navigate to the temperature control menu (Main -> Control -> Temperature) and set the nozzle temperature to approximately 215°C.

Feed the end of the filament through the lower hole in the extruder body, across the feed gear, and into the exit hole above the feed gear. Let the idler bar drop back into position once the filament is properly fed, and place the clamp springs back onto the idler bar.

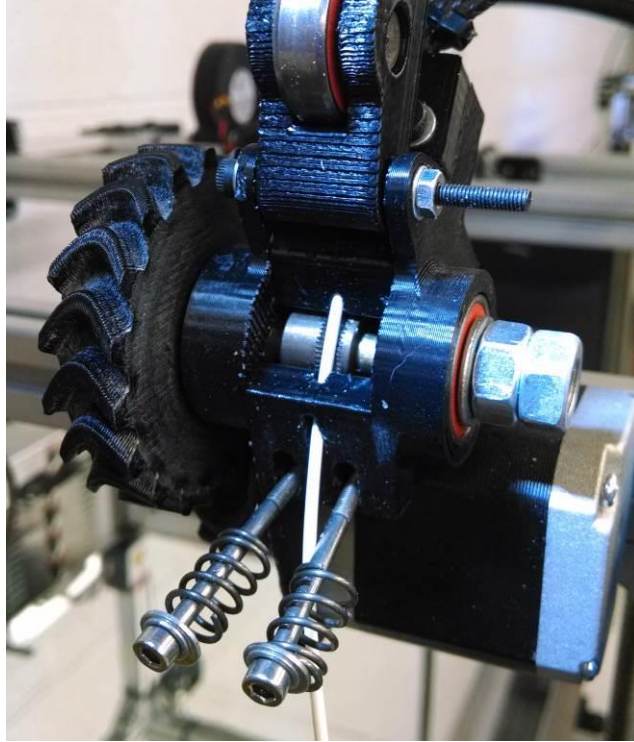

Figure 18: Filament Fed Across Hobbed Gear

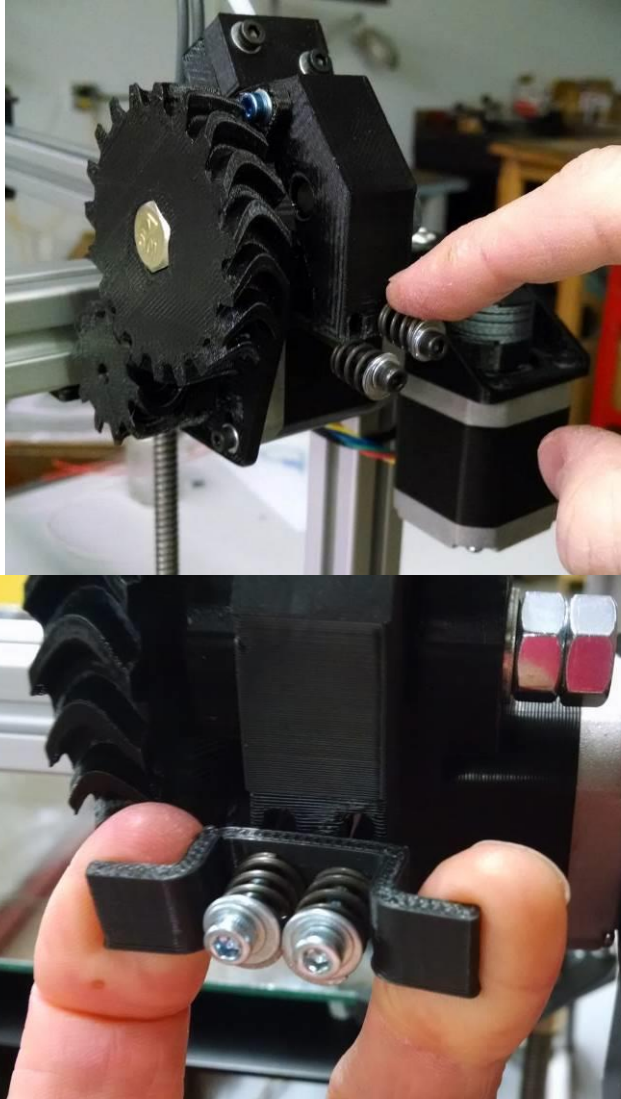

Figure 19: Disengaging the Idler Bar Springs (top-original extruder, lower -current extruder)

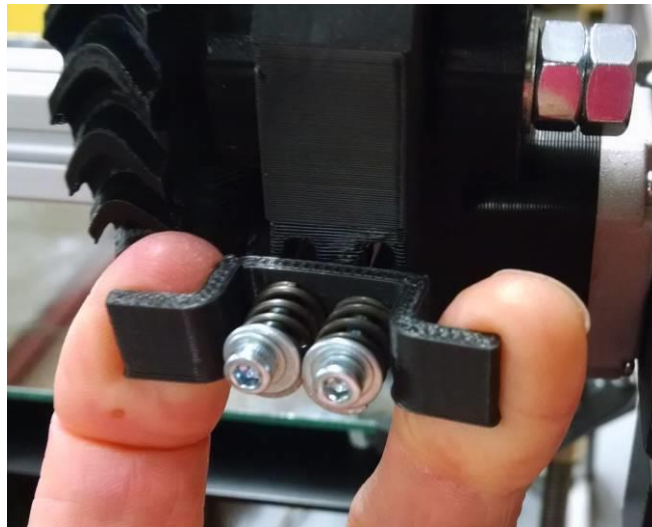

Figure 20: Engaging the Idler Bar Springs (top-original extruder, lower – current extruder)

Both: Slowly turn the large gear on the side of the extruder. Watch for the tip of the filament to come into view inside the feed tube at the exit of the extruder. If you feel a sharp increase in resistance to turning the gear, **STOP** and remove the filament. There may be debris in the tube or some part of the feed system has come out of alignment. Once you see the filament just appear in the feed tube, proceed to the next step.

Automatic Loading: After the filament is fed about 1.5 inches into the tube, press the control knob to tell the printer the filament is loaded. After the print head is up to temperature, your F306 will automatically feed the filament through the tube and purge the print head. When that is done, the F306 will turn the heaters off, and you are ready to print!

IMPORTANT: The automatic load script does not “know” where the filament is in the system. It’s important not to manually feed it any further than 1-1.5 inches into the tube. Otherwise it may attempt to feed the filament too quickly into the print head and damage the system.

Manual Loading: While the print head is heating, turn the large gear on the side of the extruder by hand to feed the filament through the tube to the print head. Once the tip of the filament enters the print head you will feel the resistance to your turning increase. At this point stop and wait for the print head to come up to temperature.

Manual: Once the print head is up to temperature, slowly turn the gear to feed the filament into the melt chamber. If you are switching materials, you will see the old material extrude and gradually transition to the new material. Continue to run new material through until no traces of the old remain in the plastic.

Unloading Filament

Automatic: Navigate to the “prepare” menu and select the “unload filament” option. Your F306 will automatically heat the print head and reverse the filament out of the extruder.

When the extruder stops turning, you can remove the springs from the idler bar and pull the filament completely out of the extruder. There may be a “string” of plastic attached to the end of the filament, it is best to remove this intact vs. breaking it off in the feed tube.

Manual: Grasp the large gear on the extruder and turn it backwards gently. Sometimes the filament will come out of the print head without needing to heat it up. If it won't come out, set the print head to about 200°C and wait for it to heat up. Feed a couple of millimeters through the heated print head and then reverse it completely out of the tube. **Make sure you turn off the heater after you've unloaded the filament!**

Secure the loose end of filament to the spool by routing it through the holes in the sidewalls or use a small piece of tape. If you do not secure the loose end, it can unspool and tangle itself.

Lastly, check the feed gear for debris in the teeth. Debris in the teeth will make the gear more prone to slipping. If you see debris, use the supplied toothbrush to clean it out.

Storing Unused Filament

Your filament is shipped in a sealed plastic package with a pack of moisture-absorbing desiccant. This is because all types of filament will absorb moisture from the air if they are left out in the open for extended periods of time.

When you are not using a spool of filament, we strongly recommend you store it in a re-sealable plastic bag, such as a Ziploc, with the desiccant pack it came with. This will keep moisture absorption to a minimum.

Leaving filament out for a couple days is not a problem. But you don't want to leave a roll out in the open if you aren't going to use it for an entire week. Filament that has absorbed moisture will not print nearly as well as dry filament.

Note: Nylon is more prone to moisture absorption than other types of plastic and should not be left in the open for **any** length of time. Nylon's printing performance degrades sharply with moisture absorption.

7.4. Cleaning and Prepping the Bed

Important: Only use water to clean the print bed! Cleaners like Windex, acetone, etc. will leave a residue on the glass and adversely affect print adhesion.

Preparing the print bed for printing is very simple! Your F306 uses a water-soluble glue stick to coat the glass and help objects stick. This has many advantages:

- It works for every material we've tried.

- It is easy to apply.
- It is easy to clean up since it is water soluble.
- It is non-toxic and non-hazardous.
- It provides consistent adhesion.

Use only Elmer's "purple disappearing" glue. If you are unable to find this, Avery Disappearing Color Glue Stick is an acceptable alternative.

Prepping for a Print

With the bed less than 40°C and previous glue removed (see below), hold the glue stick perpendicular to the bed and apply to the bed with parallel, slightly overlapping wipes. The goal is an even, light coating on the glass. For PLA, a single layer of glue is sufficient. For ABS, 2 layers of glue laid down at 90° to each other are needed.

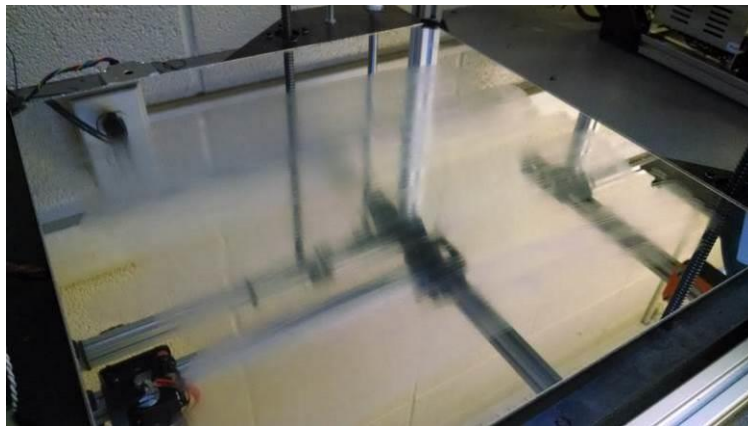

Figure 21: Bed Prepped for PLA

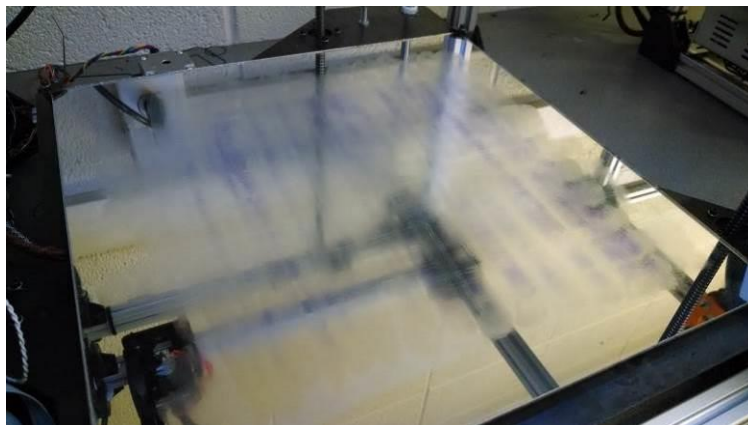

Figure 22: Bed Prepped for ABS

Miscellaneous Notes

- If you are printing a small part, you only need to coat the section of bed where the part will be printed.
- You want to apply the glue to a cold bed (<40°C) shortly before beginning a print. The longer the glue sits, the less sticky it becomes.
- Applying the glue when the bed is hot will result in the glue stick melting as you apply it, and the glue goes on too thick.

Cleaning Off Glue from a Previous Print

With the bed less than 60°C, lightly spray the bed with water and let it sit for 10-20 seconds.

Use your included part scraper to scrape the majority of the glue to the rear of the glass in a front-to-back pattern. Wipe this up with a paper towel.

With a clean section of your paper towel mist the bed and use single direction strokes to achieve clean glass.

It's not necessary to get the bed perfectly clean, but there should be no deposits of glue left.

7.5.Slicing and Printing a File

Refer to the Simplify3D tutorials for detailed information on using the software.

Import the model into Simplify. Adjust scale, orientation and position as needed.

Add a process. Check the following in the process box that pops up:

- Material type
- Layer height
- Infill amount
- Support generation on/off

(Some of these may require you to click "show advanced.")

Once everything is configured properly, click "prepare to print." Simplify will process (slice) your part and present a 3D preview of the toolpath. This is helpful to check that everything is going to work correctly.

Once you're happy with how everything looks, click "save toolpaths to disk" and select a location to save the .gcode file. For large files, it seems to work better if you save it to your hard drive and then transfer the file to the SD card vs. saving it directly to the SD card.

Next, eject the SD card from your computer and transfer it to the control panel of your F306.

Power up your F306 and prepare the bed for printing.

Navigate to the SD card menu (main menu -> card menu) and scroll through the list to find the file you just prepared in Simplify. Press the scroll wheel to select the file. The rest is automatic! Your F306 will home and heat the bed and print head to the correct temperature and the print will begin automatically, once the correct temperatures are reached.

7.6. After a Print Completes

At the end of a print job, your F306 will automatically lower the build table to the lowest position and turn off the heaters. It is normal for the small 30mm hotend cooling fan to continue to run (this fan runs continuously.)

Removing PLA Parts

For small- and medium-sized parts, you will probably be able to twist them loose by hand, or use your scraper to pry them loose from the bed. If moderate force doesn't work, don't force it! Excessive force can cause misalignment of the bed or Z axis.

For large PLA parts or PLA parts that are particularly stubborn, manually heat the bed to 70°C and allow it to reach temperature. This will soften the bottom layers of the part and allow you to wedge the part scraper under the part and progressively separate the part from the bed. After the part separates, turn the bed heater off.

Removing ABS Parts

ABS parts will self-release from the bed when it cools below ~50°C. Attempting to pry them off the bed while the bed is hot is not recommended: It's a good way to burn your hands and bend your parts.

Removing Nylon Parts

Wedge the part scraper under a corner of the part and slowly slide it under the part at a shallow angle. Too much angle can cause the part to bend permanently. Nylon is fairly flexible so typically it is easy to get the scraper under the part.

All Materials

After removing the part, remove the priming skirt that is printed around the part and the priming strip done at the home position.

It is also good practice to inspect the print head tip for excess plastic that may continue to drip out as the print head cools. If there is more than ~1mm of material on the head, it's a good idea to remove it gently with your fingers when the print head is cool.

Sometimes the nozzle will have debris stuck on it that cannot be removed when the nozzle is cold. In this case, heat the nozzle to 220 degrees using the control panel and very carefully wipe it with a paper towel folded over multiple times with a quick "pinching" motion. Be very careful you do not stay in contact with the nozzle for more than an "instant" the nozzle is very hot when you are doing this operation. See the pictures below for more guidance on this operation.

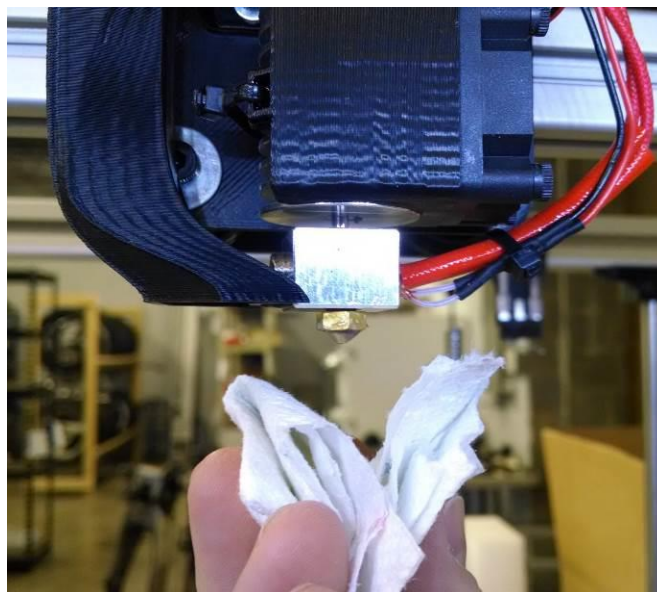

Figure 23: Using a paper towel to wipe debris from print head

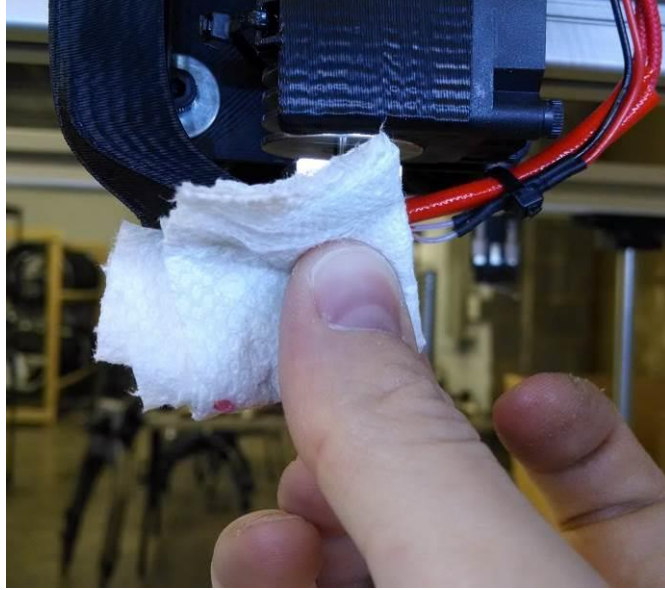

Figure 24: Using a paper towel to wipe the print head



Figure 25: Clean debris-free nozzle

8. Troubleshooting & Advanced Techniques

This section covers how to troubleshoot some common problems and some more advanced techniques.

8.1.Simplify3D Guidelines

While Simplify3D is easy to use, there are certain rules to keep in mind that will ensure you get the best results.

Part Orientation

The most important thing to keep in mind is the orientation of the part you are trying to print. The ideal situation is an orientation that:

- Has the largest flat face of the part oriented against the build plate

- Has little to no overhangs

The pictures below show the ideal and poor orientations for a particular part.

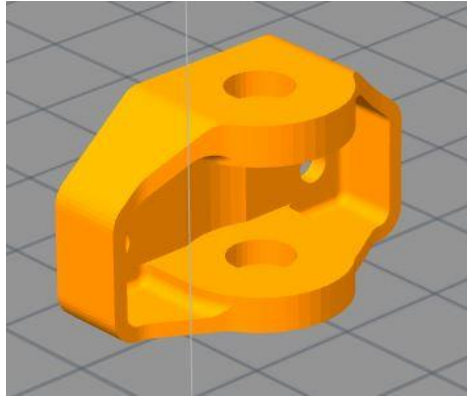

In the example shown above, we have satisfied our criteria for a large face to sit on the build plate. However, the entire upper flange is unsupported and will not print properly without support structure.

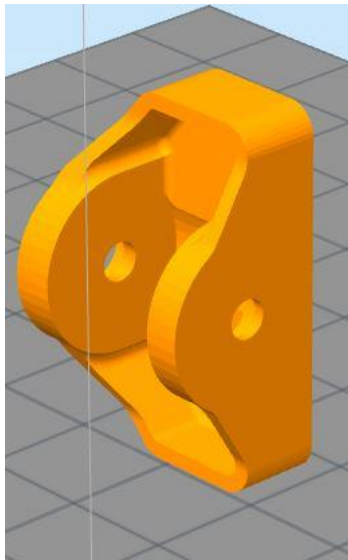

In the orientation above we've reduced the amount of the part that is unsupported in free air. However we have a small face in contact with the build plate.

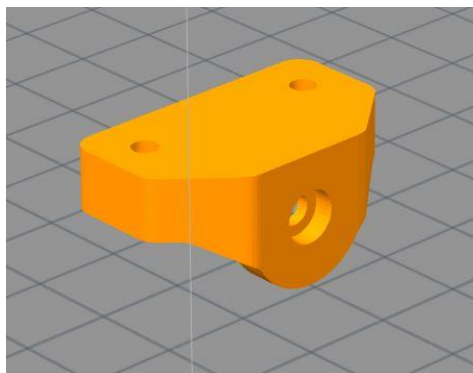

This orientation is doing everything wrong. We have a very small amount of the part in contact with the build plate and the entire part is an overhang!

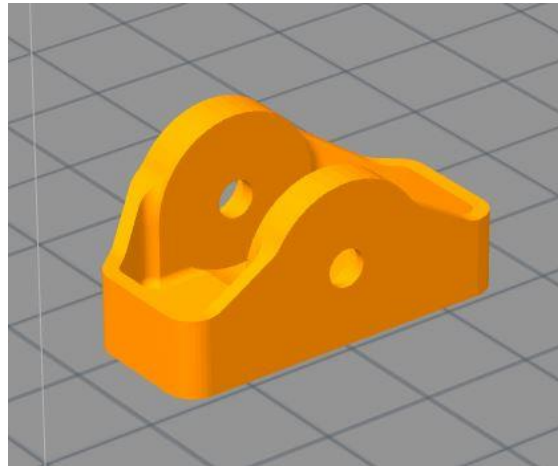

This is the correct orientation for this part. We have a large flat face on the build plate, and overhangs are minimized.

Figure 26: Correct and Incorrect Part Orientations

Checking Files Downloaded from the Internet

There are many sites online that have free models for you to download and these can be a great way to get printing quickly. However, the quality of the models can vary widely. This section will cover the most common issues and how to fix them.

Missing Faces, Inverted Faces, Non-Manifold, Etc

Simplify has some built-in utilities to detect common problems with .STL files. You can use these utilities by selecting *Repair > Identify Non-Manifold Edges*.

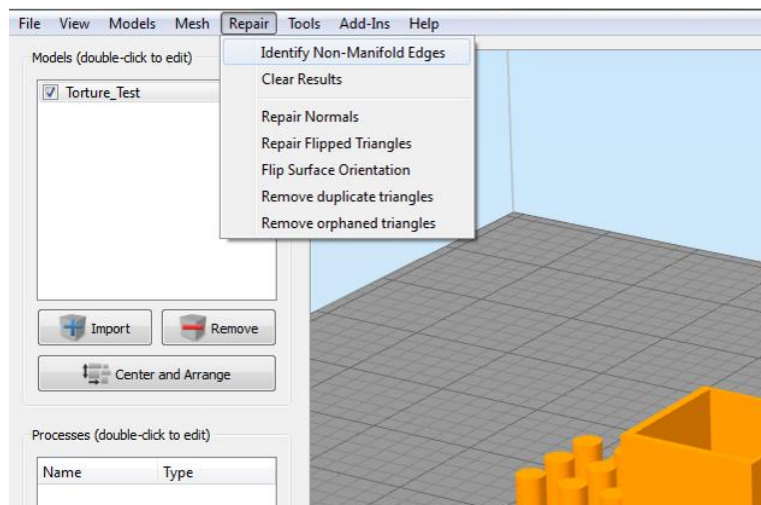

Figure 27: Identify non-manifold edges

If the model has any issues, Simplify will alert you with the following dialog box. It will highlight the problem areas on the model with red lines.

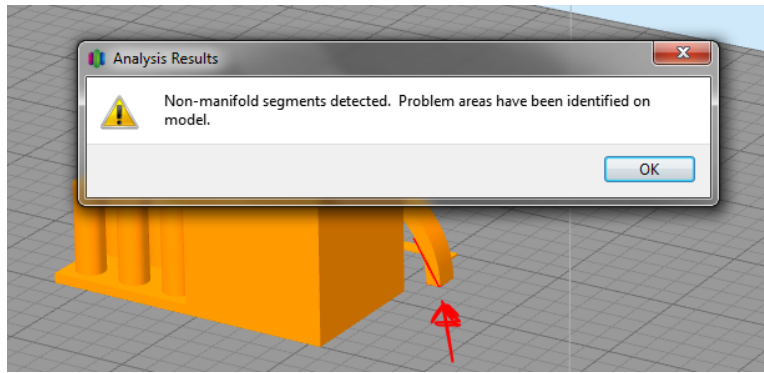
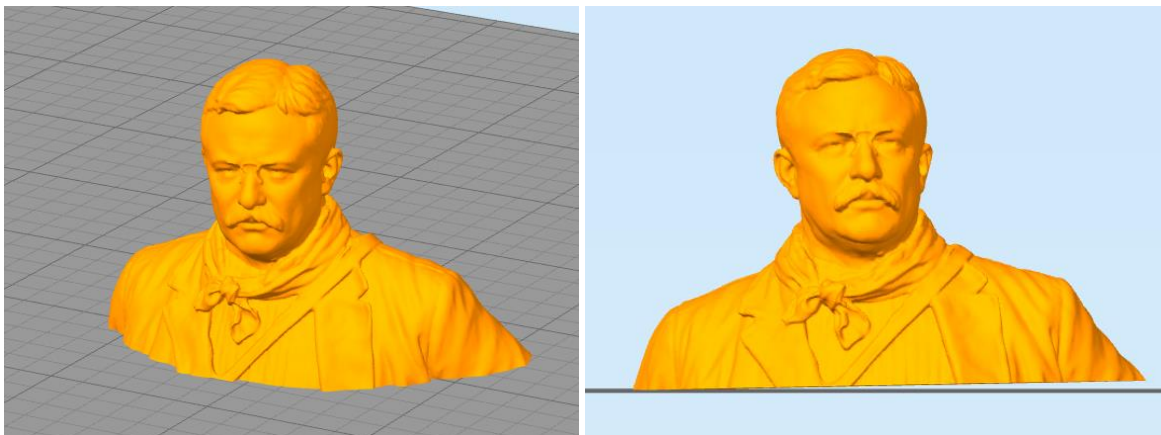

Figure 28: Problems highlighted on the model

The easiest way to fix these errors is to use an automated cleanup tool such as Netfabb cloud (cloud.netfabb.com.) This is a free service that will fix 99% of all STL issues without any user input needed. It does require a Microsoft online account, however.

Model Does Not Sit Flat

Some models have a very slight tilt in one or more axes, and even though they appear to sit flat on the build plate, they do not. This will cause issues with the part adhering to the print bed, since the first layer doesn't cover the whole bottom of the part.



(left) model appears to sit flat, but panning the view to the front shows a tilt (right)

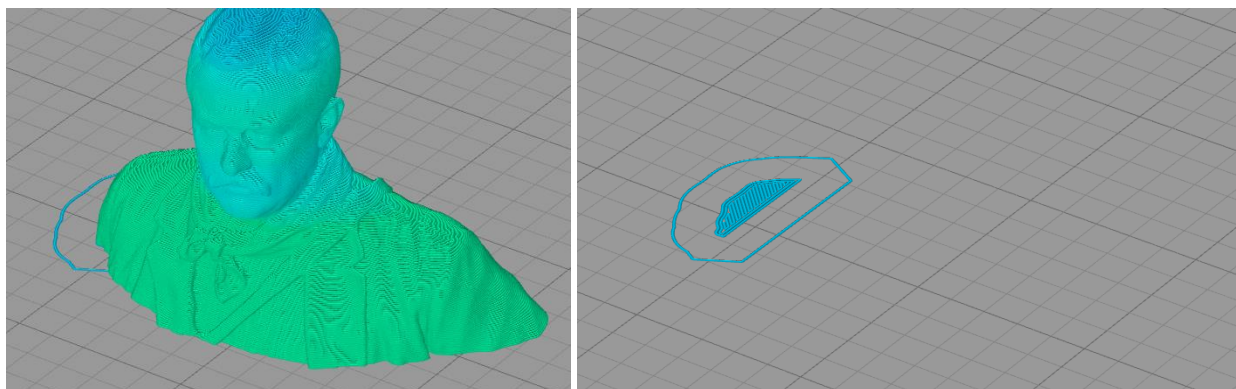

Figure 29: Identifying and correcting parts not sitting flat on print bed

If we preview the toolpath, we quickly see there is a problem. Note that the skirt does not outline the whole object, and the first layer is a tiny fraction of what it should be.

You can correct this by manually playing with the model's rotation in Simplify until you get the first layer to cover the whole object like it should. This can be a bit tedious, however.

Another option is to go to the *Edit* menu in Simplify Version 3.0 or later and select "Place Surface On Bed." This will give you a selection tool to select a single polygon on the part that you want against the bed. Select one of the faces on the desired bottom of the part and the whole part will stick flat against the bed.

Model has Internal Geometry

Sometimes when inexperienced people make .STL files by combining multiple files into one, they end up with internal geometry (faces inside the model). This can cause Simplify to become confused about what the outside of the model actually looks like. Here's an example of what that can look like.

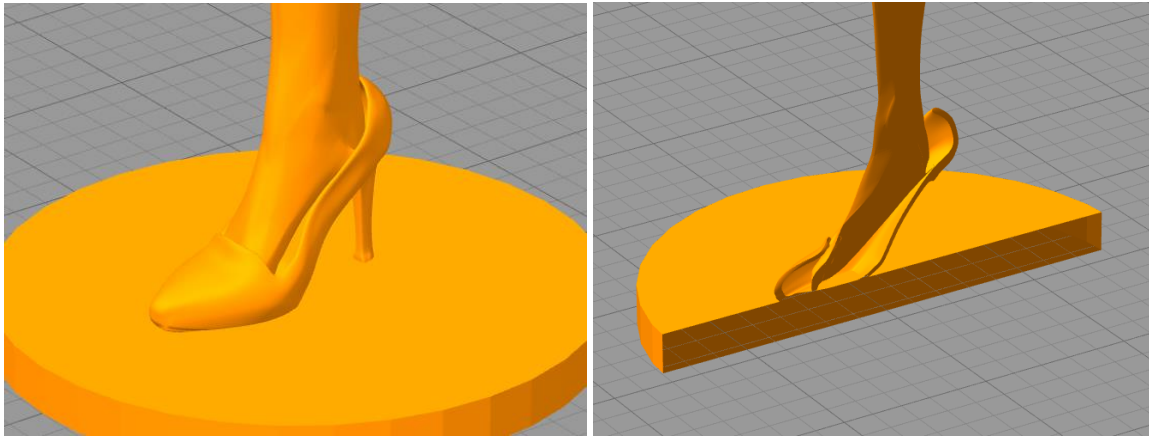

Figure 30: Models built by combining two different CAD files can cause printing problems

Here we're using Simplify's cross section tool to look inside the .STL. What we see is that the creator of this file most likely took an off-the-shelf model of a shoe, along with a model of a leg, and simply put them together. There is a lot of internal geometry, like the toes on the foot and the fact that the shoe is hollow, that simply does not need to be there.

Unfortunately there's usually not a whole lot you can do about a model like this. Passing it through netfabb might improve the situation, but it's unlikely to completely fix it. Sometimes, these sorts of things print fine, even with errors. Other times, they don't. If you decide to give it a try, preview the toolpath carefully before printing!

Overhangs and Support

While it is ideal to minimize overhangs when you orient your parts for printing, Simplify3D has the capability to automatically detect overhangs and generate a temporary scaffolding (commonly called "support structure") to provide a surface on which to print these features. After the print is complete, this scaffolding is broken away by hand.

Support structure can be turned on by checking the “generate support” check box in the process settings dialog window. Support structure is on by default in most material settings.

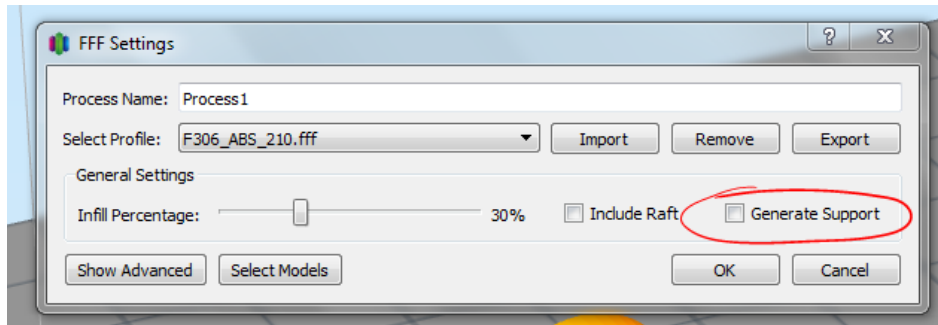

Figure 31: Generate Support toggle

More advanced control of support generation options can be found on the “Support” tab in the Process Settings dialog window by clicking “show advanced.”

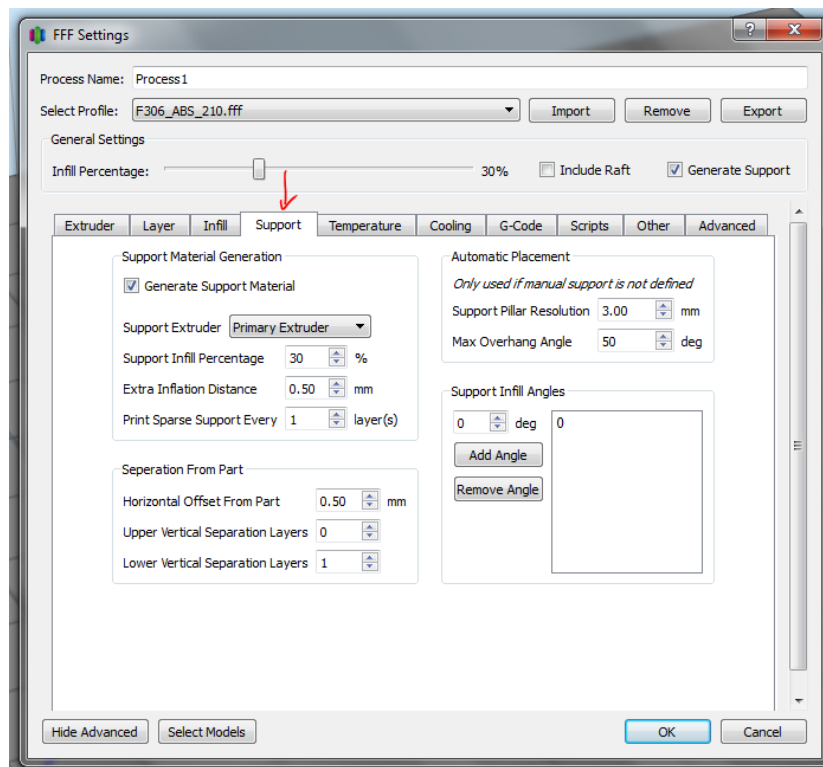

Figure 32: Advanced Support Options

When in doubt of the necessity of support, leave it on and let Simplify figure out where it’s needed. It may sometimes generate support where it’s not actually needed, but that is the safer option.

More detail on Simplify’s support generation can be found on their tutorial page:

<http://www.simplify3d.com/support/tutorials/adding-and-modifying-support-structures/>

Here's an example of support in action. The following part, even when it's oriented in the "correct" position, still has an unsupported flange that will not be printable without support material.

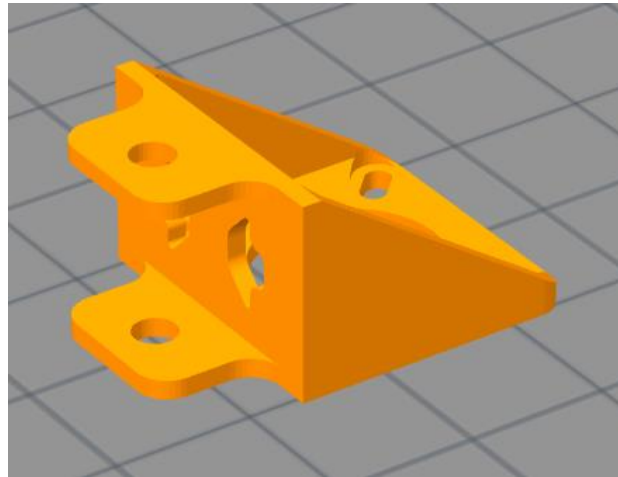

Figure 33: Bracket

If we instruct Simplify to generate a preview of where it thinks support is needed, we see it generates the following:

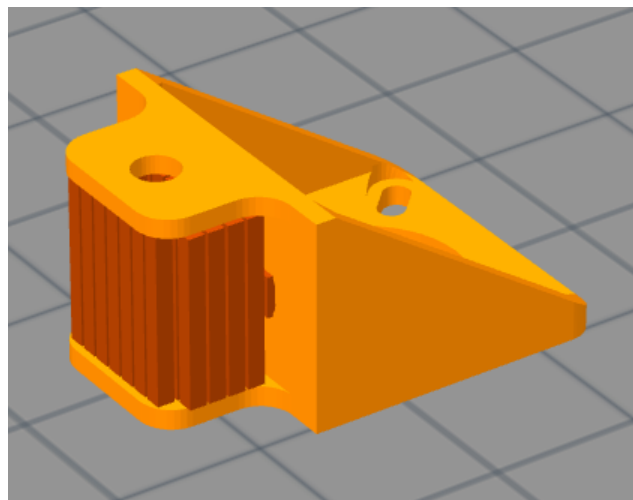

Figure 34: Bracket with Support

It's important to note that if you left support turned off for this part, Simplify would not give you an error message when you prepared the part for printing. It assumes you know when support is or is not needed.

Speed vs. Quality

The default slicing settings are set up for 100mm/s print speed and 0.2mm layers. We've found this is the best compromise between print time and output quality. If you desire, you have full control over these parameters in the Process Settings window.

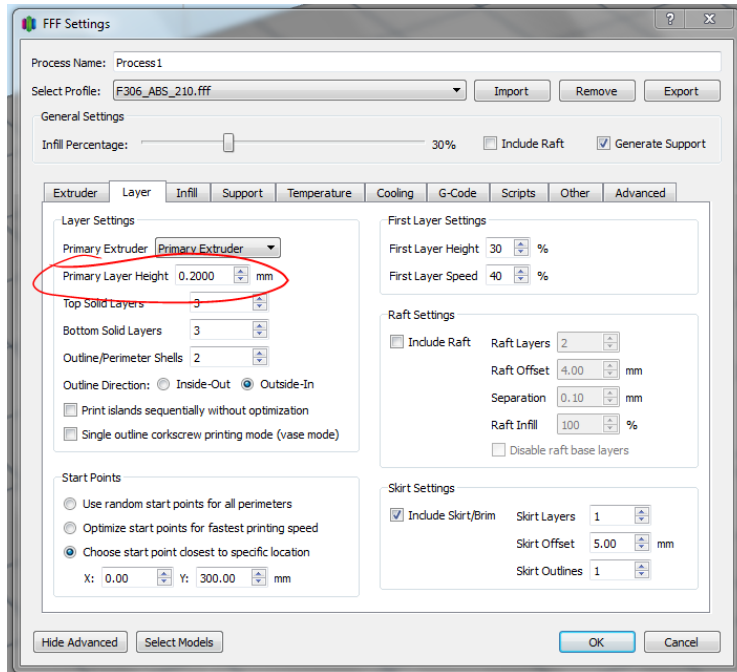

Figure 35: Layer Height is set on the Layer Tab

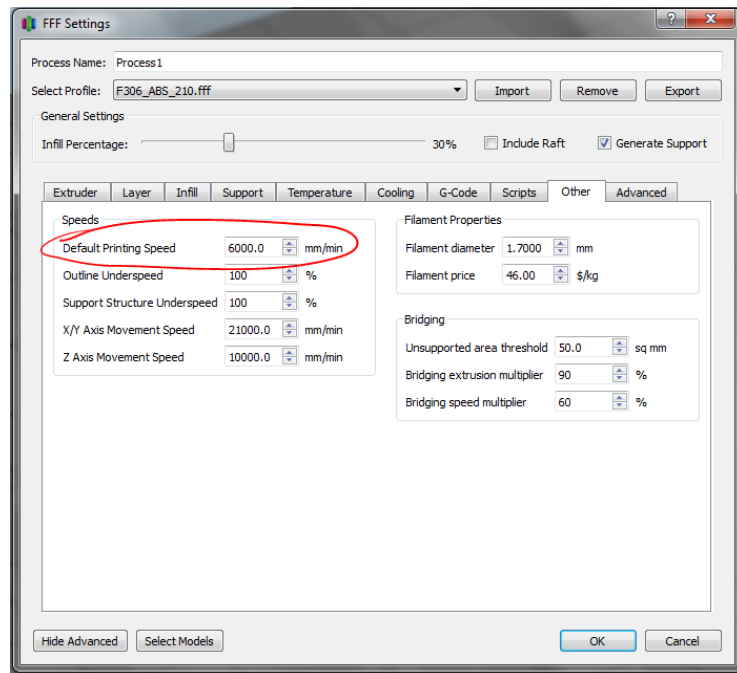

Figure 36: Print Speed is set on the Other tab

Layer Height Limits

Too tall of a layer height will result in poor intra-layer adhesion because they are not “squashed” together enough. **In general, you should not exceed 0.3mm tall layers.**

Low layer heights have a different constraint. At or below 0.1mm layer heights, the ability of the extruded plastic to bridge over small gaps becomes degraded due to the low flow rate. Depending on the geometry you’re making,

this can range from not an issue at all to ruining the print. In general, we don't recommend lower than 0.15mm layers because the increase in surface finish quality is not worth the additional hassle.

If you have issues with the top solid layers not bridging the sparse infill, there are a few things to try:

- Increase the infill density
- Increase the number of perimeters (helps more for organic objects with shallow slopes)
- Drop the extrusion width to the size of the nozzle (default is nozzle size +0.05mm)

8.2.First Layer Height

This section will describe how to diagnose an improperly set first layer height. The bed leveling procedure described earlier in this document has yielded very consistent, ideal results in our testing. That being said, it is **not** foolproof. Symptoms of improper first layer height may include:

- The part is not sticking to the bed on the first 1-3 layers (first layer is too tall)
- Obvious gaps between the extrusion beads are visible (first layer is too tall)
- Excess plastic is piling up between the passes of the head (first layer is too close)

Below are images that show too tall, too close, and perfect first layer heights.



Figure 37: First Layer is Too Tall

The first image shows a first layer that is too tall (the print head is too far away from the print bed.) You can see gaps between the traces of plastic that were laid down. You can also see that the infill is poorly bonded to the outline of the object. The scrap of plastic on the outside is the priming loop that did not bond to the bed: further evidence that that first layer is too tall.

To correct this, the bed and print head need to be closer to each other. The corner bolts need to be turned counter-clockwise. Begin backing the bolts out little by little, attempting to move each corner the same amount. The goal is to maintain the level and the entire bed be moved in the same direction, not one corner or side more than the others. Make the necessary adjustments while monitoring the passes during this failed first layer. Once the passes seem to be more ideal, reset the printer, manually retract 6mm of filament, manually lower the bed and remove all extruded plastic. Restart the print and monitor the first layer. The main problem with too-tall a first layer is that the part will not be bonded strongly to the bed, and can detach during the print job.



Figure 38: First Layer is Too Close

This image shows a first layer that is too close. The infill traces are bonded to their neighbors, but we can see excess plastic that accumulates above the infill traces. This is less of a problem than a first layer that's too tall. But in extreme cases, the print head and bed can be so close that no plastic is extruded at all. This can cause problems with the extruder slipping or jamming.



To correct this, the corner bolts should be tightened (threaded in clockwise.)



Figure 39: First Layer is Correct

This last image shows a "perfect" first layer. The infill traces are firmly bonded to each other, but we see no excess plastic building up between them. Of course, no excess is ideal, but you will most likely see some in different spots of the print. When you can see the excess being pushed up across the entire print, that's when it is too close.

This graphic from MatterHackers may also be helpful in understanding what the first layer does:

Nozzle Height	View	Info	Y/N
Too High		Too much distance will cause the filament to extrude into the air. This will not stick to the bed.	✗
Perfect		The tip of the nozzle is adding slight pressure to the top of the filament, greatly increasing how much filament is securely sticking to the bed and subsequent layers.	✓
Too Low		The filament is not flowing properly, which can cause retrograde extrusion. Layers are predominantly choppy and short. Continued printing in this manner will likely cause a jam.	✗

8.3. Temperatures & Other Information

Printing temperatures for the most common materials:

PLA:

- Print head: 200–220°C
- Bed: 45°C
- Coat bed with 1 layer of glue.
- For slow prints or prints with many successive retractions, reduce temperature to ~200°C.
- Increasing print speed will need a relatively large increase in temperature.

ABS:

- Print head: 240–255°C (ABSpro 260–270°C)
- Bed: 100–110°C
- Coat bed with 2 layers of glue at 90° to each other.

Nylon-618:

- Print head: 245–250°C
- Bed: off
- Coat bed with 2 layers of glue at 90° to each other.

Taulman Bridge Nylon:

- Print head: 245°C
- Bed: 70°C
- Coat bed with 2 layers of glue at 90° to each other.

Taulman T-Glase (PET):

- Print head: 240°C
- Bed: 75°C
- Coat bed with a single layer of glue.

Miscellaneous Notes

- Lower temperatures may be needed for slower print speeds. The above temperatures have been tested to work with the stock F306 print speeds.
- Higher temperatures will result in better layer-to-layer bonding and increased part strength.
- Higher speeds require higher temperatures to maintain layer-to-layer bond strength.

8.4. Part Warp (printing large parts)

Theory

Thermoplastics contract as they go from liquid to solid. This contracting causes the molten and cooling upper layers to exert a pulling force on the lower layers, which have already solidified. If enough of this pulling force is generated, you'll see the bottom corners of the part start to lift from the print bed. Larger parts, because they contain more plastic, will have an increased tendency to warp. Certain shapes such as sharp corners are also more prone to lifting from the bed. While we can't eliminate this behavior, we can mitigate it with various techniques.

General Techniques

Decrease first layer height slightly by raising the bed.

Use "Brim."

ABS

Print on bare glass with the same bed temperature. Use caution when using this technique as parts may adhere strongly enough to damage the glass.

PLA

Print on bare glass. Set first layer temperature to 60°C, other layers to 51°C. As with ABS, this may result in very strong part adhesion. Use caution when removing parts.

8.5. Printing Small Parts

Theory

With small parts and short layer times, excess heat may build up in the part and prevent the plastic from solidifying adequately before the next layer is laid down. This will result in poor output quality and, in extreme cases, may result in failed prints.

While there are automatic cooling settings in Simplify that will control the cooling fan and print head speed, these techniques can only do so much.

In Practice

The simplest method to make small parts print well is to print multiples of them, and space them out on the bed.

8.6. Print Head & Extruder Jams

Extruder system jams can have many causes. We'll cover the most common and how to recover from them here. You'll usually see one or more of the following symptoms when there is a problem:

- Material stops flowing out of the print head (usually happens first)
- The extruder motor skips, usually accompanied by a skipping, chirping, or grinding sound
- The extruder continues to turn, but the feed gear chews up the filament

If you experience an extruder or print head jam, you will need to halt the current print, as a jammed extruder generally does not self-recover. Then you will need to diagnose why the jam occurred, and take corrective actions to prevent it from occurring again. If you merely clear the jam without diagnosing the root cause, the jam will likely occur again in short order.

Thermal Jams

Thermal jams primarily occur at the print head and, if not caught, can cause a slip or jam at the extruder. Some common causal chains are below:

1. Print head temperature too low -> extrusion force is too high -> extruder slips or stops turning
 - a. Use correct print head temperature for the material
 - b. This can also be caused by using low quality material, particularly ABS.
2. Print head temperature too high -> heat conducts up filament -> filament swells and locks up in cold section
 - a. Use correct print head temperature for the material
 - b. This can also be caused by using low quality material, particularly PLA.
3. **(Most common)** Filament retracted too far at end of print -> molten filament pulled into cold section -> filament solidifies in shape of cold section -> filament cannot be fed forward or backward, and cannot be melted
 - a. Generally occurs if print is manually aborted and user manually retracts filament too far.
 - b. To fix, stall the 30mm fan with something soft (like the tail of a zip tie). The fan will detect it's stalled and shut down to prevent burning up. Manually heat the print head up to 220°C and allow it to sit at temperature for 10-20 minutes. The objective is to allow heat to soak into the cold section; with the fan removed it will not be pulled away like normal operation. Ideally, this heat will soften the jammed plastic enough that we can push it back down into the print head. To attempt to feed the plastic forward, firmly hold the idler bar closed with your hand and slowly

turn the large gear on the extruder in the feed forward direction. If it doesn't clear after 3 attempts, please contact Support@fusion3design.com for assistance.

- c. It may help to insulate the finned section by wrapping a paper towel or rag around the fins to retain additional heat.

Mechanical Jams

Mechanical jams can occur at either the print head or the extruder. Some common causal chains are below:

1. First layer height is too low -> no filament extruded -> extruder slips or stalls
 - a. Correct the first layer height.
2. Extruder idler bar springs are too loose -> extruder does not grab filament -> extruder slips
 - a. Tighten the extruder idler springs.
3. Print requires many rapid retractions in quick succession -> filament near the feed gear heats up and softens -> filament partially melts and flattens out from extruder idler pressure -> filament no longer feeds through extruder -> extruder slips
 - a. Decrease the retraction speed (contact support for assistance.)
4. There is an imperfection in the filament diameter (usually a bulge) -> filament does not feed into extruder -> extruder slips
 - a. Cut out the affected section of filament, inspect the remainder of the spool for additional imperfections.
5. Debris on the surface of the filament, or in the filament (very rare) is fed into the print head -> the debris is large enough to block the hole in the nozzle -> plastic stops extruding out the clogged nozzle -> the extruder slips or stalls
 - a. Clear debris out of the print head.
 - b. Make a filament wipe out of a piece of paper towel and clothes pin to wipe off the outer surface of the filament.
6. (V5 print head only) Strings and "hairs" of filament attached to the end of the filament can jam at the top of the print head when the filament is re-loaded. This is because there is a chamfer at the top of print head where the filament feeds into the print head.
 - a. This video covers how to remove the print head and clear the jam:
<https://www.youtube.com/watch?v=68RRTFjxMPo>
 - b. To prevent this from happening, trim the tip of the filament clean every time. When unloading the current roll, be careful to keep the strings and hairs attached to the tip – they like to break off in the tube.

8.7. Z Axis Noise

Your F306 Z axis is lubricated with a noise-damping lithium grease on the leadscrews and guide rods. In general, you should not hear any noise from this system. Some degree of humming or buzzing during long movements is not a cause for concern. If it annoys you, wiping off the existing grease and re-applying a lithium-based grease should improve performance.

IMPORTANT: Do not use any other type of lubricant on the Z axis system (lead screws and guide rods.) Use of other lubricants may void your warranty.

8.8. Experimental Materials

Your F306 comes with presets for the most common plastics such as ABS, PLA, Nylon blends, etc. However, it is capable of printing nearly any thermoplastic that is available in filament form. Please contact support@fusion3design.com for assistance in working with other materials. In general, we're able to provide a good starting point for further experimentation, if not a complete and tested material profile.

8.9. Different Print Heads

Over the course of production of the F306 Generation 1, we have used two different print heads. For troubleshooting purposes, support may ask which print head your machine is equipped with. This is how to identify which print head you have.

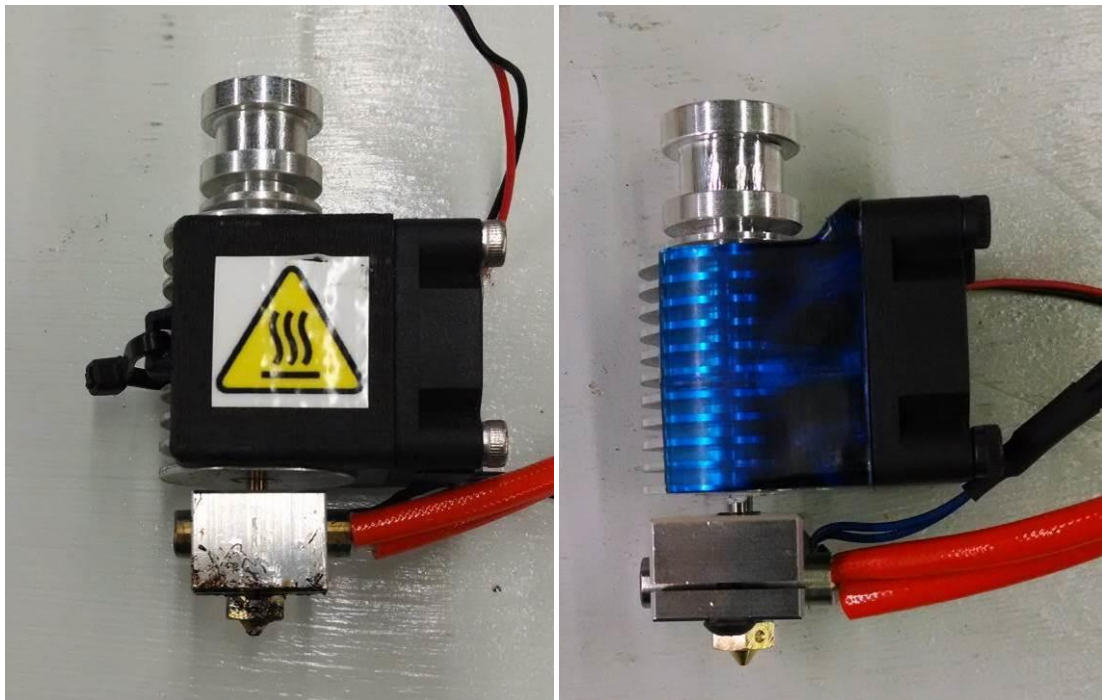

E3D V5

E3D V6

Figure 40: E3D Hot-end versions

- Fan duct: V5 has black duct and V6 has translucent blue duct

- Heater cartridge: V5 uses set screw to retain heater and V6 uses a clamping screw that bends the block around the heater
- Thermistor: V5 has semi-clear leads on the sensor and V6 has blue or black braided leads on the sensor

9. Maintenance

9.1. Extruder Idler Bar Springs

In order to ensure the extruder maintains good grip on the filament, it's important to periodically check the springs that clamp the extruder idler bar in place.

Recommended service interval: once per month or every 40 hours of run time

Use the 2.5mm wrench in your toolkit to tighten the two bolts as far as they will go. They will stop turning when the tips of the bolts make contact with the extruder motor.



Figure 41: Tips of Bolts Bottomed Out on Motor

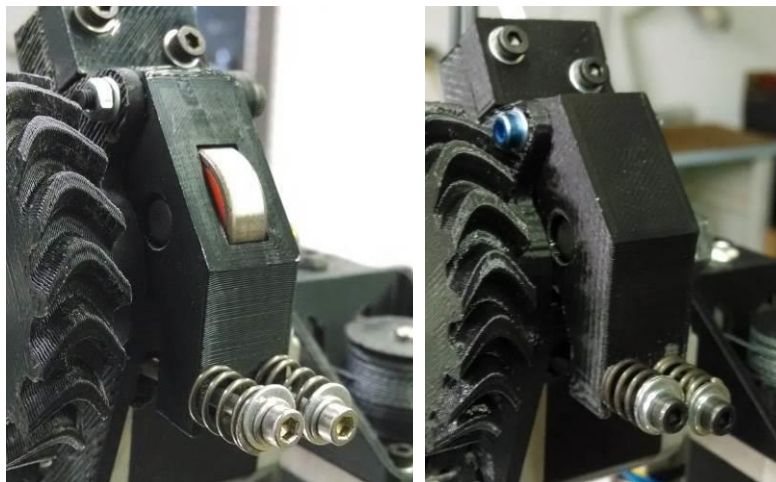

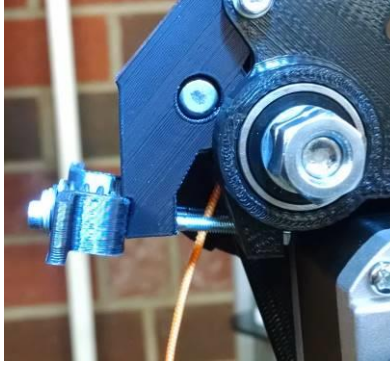

Figures 42: Rev 1 idler bar (left) and rev 2 idler bar (right) and rev 3 idler bar (bottom)

- For extruders with the idler bar that shows the idler bearing, reverse the bolts 1-1.5 turns.
- For extruders with the larger idler bar, reverse the bolts 2-2.5 turns.
- For extruders with the “spring grabber” handles, set the gap between the washer on the bolt and the plastic of the spring grabber to 0.43”. **You MUST have filament in the extruder when you make this measurement!**

You should be able to slide the springs on and off the idler bar with your fingers with moderate force. If you can't disengage the springs by hand, try loosening the bolts an addition half turn.

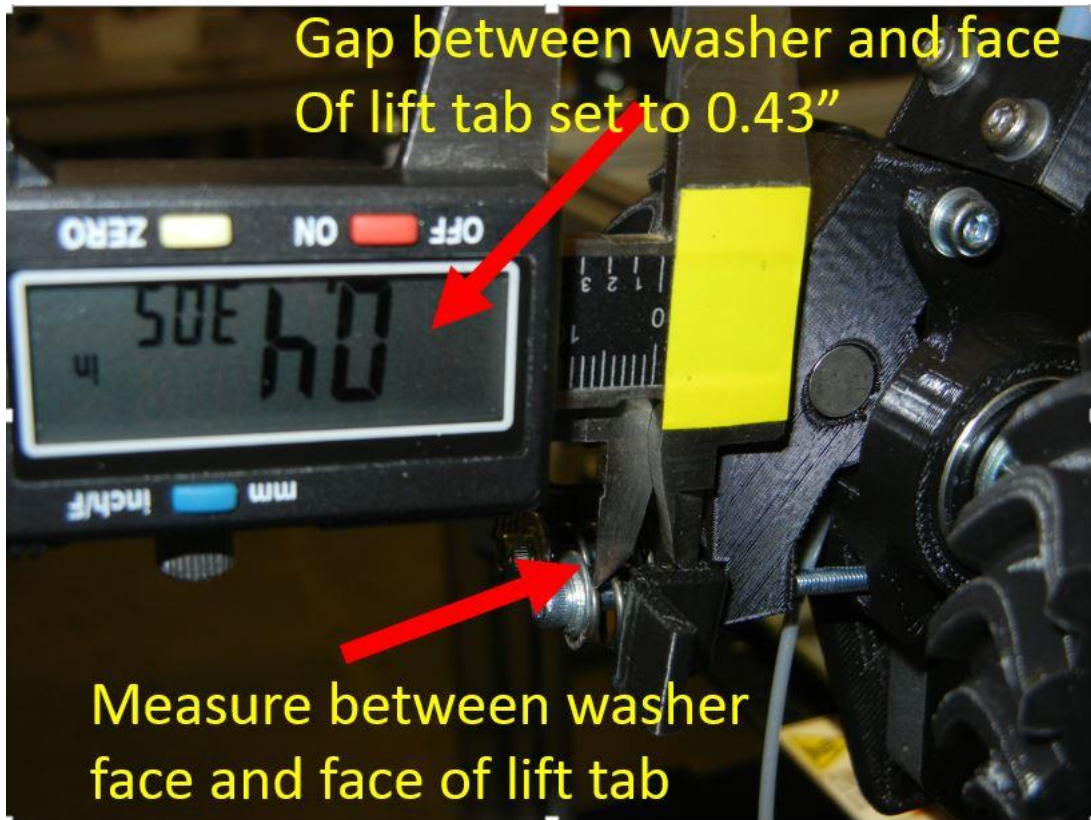

Figure 43: Measuring spring gap for correct extruder spring tension.

9.2. Drive Cable Tension

The X and Y axes are driven by a pair of high-tensile-strength spectra lines. These lines are tensioned with moveable idlers on the rear of the machine. Check for tension by gently “plucking” the cables in the center of the rear span. The lines should be fairly tight, but not so tight they “hum” like a guitar string.

Recommended service interval: once per month, or every 40 hours of run time



Figure 44: Checking XY Drive Cable Tension

If the cable tension is too low, first check that the idler brackets are in line with the extrusion; it's possible one was knocked out of alignment during shipping. To correct this, simply grasp the bracket and slowly pivot it back in line.

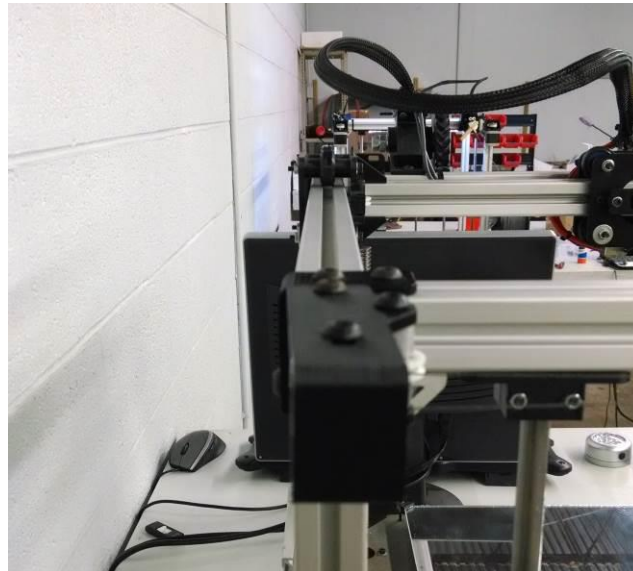

Figure 45: Idler Bracket Out of Alignment



Figure 46: Re-aligning Idler Bracket

If the brackets are properly aligned but the cable tension is still too low, you can adjust the moveable idlers. To do this, you will need a 4mm hex wrench and 10mm socket. Loosen the bolt on one of the idlers and slide it in the slot to achieve proper tension. Then re-tighten the bolt.



Figure 47: Adjusting the Idler Tension

If you adjust the cable tension, it's a good idea to check the square of the X crossbar (see section below).

9.3. X Crossbar Square

The angle the X crossbar makes with the Y rails is determined by the relative cable tension in the two XY drive cables. In order to get dimensionally accurate parts from your F306, the crossbar must make a 90° angle with the Y rails.

Recommended service interval: once per month, or when the cable tension is adjusted

Measure the two diagonals shown with a tape measure. The exact measurement is not important, what is important is that both measurements are the same. Butt one end of the tape measure into the corner made by the X axis and the Y carriage plate. Make sure it's seated in a repeatable manner. Measure to the middle bolt on the front wrap brackets. Measurements should be within 1/16" of each other.

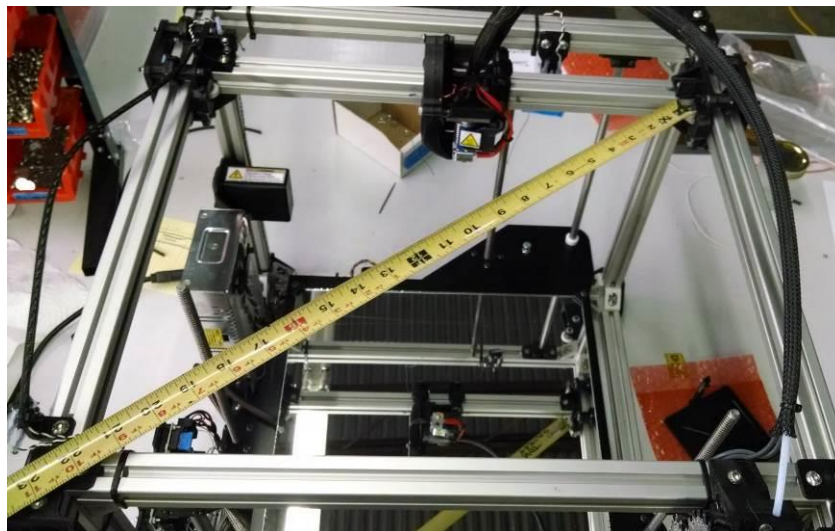

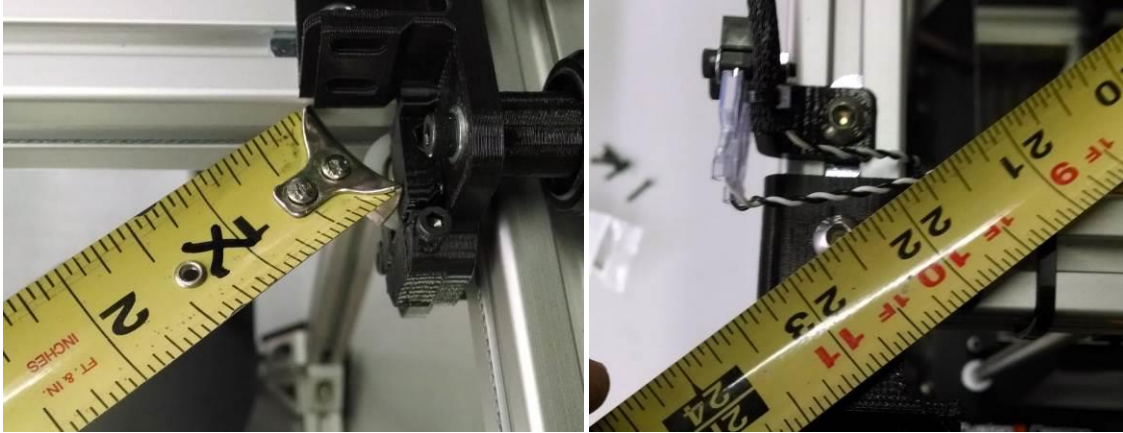

Figure 48: Checking Frame Square

To adjust the square of the X crossbar, lightly pull on one of the drive cables at the rear to determine which cable needs to be re-tensioned. When you have identified the correct cable to adjust, you will see the X crossbar square improve when you add some tension by hand. Then, loosen the corresponding bolt and slide the idler pulley forward or back to decrease/increase tension, respectively, until the X crossbar forms a 90 degree angle to the Y axis.

9.4. Z Axis Rods and Leadscrews

The Z axis leadscrews and smooth rods on your F306 are lubricated at the factory with a long-life lithium-based grease. This lubricant should provide thousands of hours of trouble-free use. The rods **should not** be lubricated with any other lubricants! Doing so may void your warranty.

Recommended service interval: once per year, or every 2,000 hours of run time

9.5. Print Head

Regular Maintenance

Remove Plastic Debris

After every print, clear leftover plastic from the print head so it will not collide with it when it homes. Stubborn plastic can be more easily removed by heating the print head to $\sim 200^{\circ}\text{C}$ and removing the now softened plastic.

The preferred method is to take a folded paper towel and use a pinching motion on the nozzle while sliding your hand away from the nozzle.

Cleaning beyond this is more a matter of cosmetics than functionality.

Recommended service interval: after every print.

Check Heat Break Tightness

Periodically, it's a good idea to make sure the heat break section is firmly threaded into the heat sink. It's also a good idea to check this if you move, adjust or otherwise touch the print head for other maintenance or service.

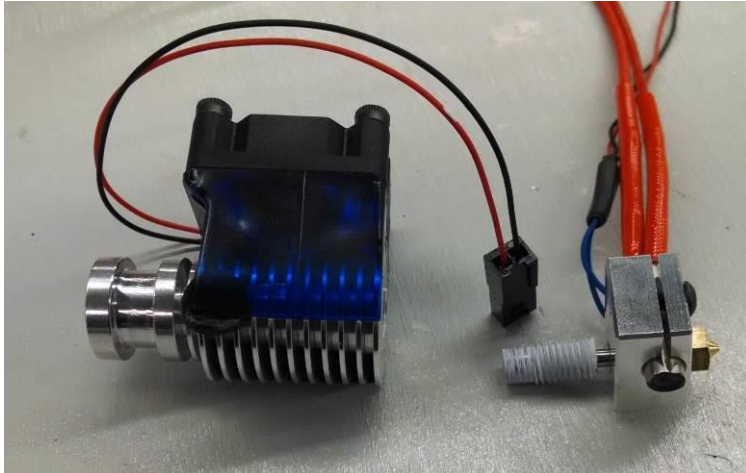

Figure 49: Print Head Assembly

The hot section of the print head (right piece in the above image) consists of the aluminum heater block, a brass nozzle and a stainless steel heat break. The top of the heat break threads into the heat sink portion of the print head (left piece.) **Do not disassemble the hot section of the print head: it has been carefully assembled at the factory to prevent leaks.**

The threads of the heat break are coated in a thermal transfer paste to aid in heat transfer from the stainless to the aluminum. If you disassemble the print head, take care not to wipe off this thermal paste.

For proper performance, it's important that the heat break be fully threaded into the heat sink. The easiest way to ensure it's fully seated is to leave the print head installed on the machine and grasp the heater block with your thumb and forefinger (while it's cool, of course.) Give it a firm but not excessive twist counterclockwise. It is possible to over-torque the heat break and damage it. So, don't apply lots of force.

From the factory, the print head is installed so that the faces of the heater block are square with respect to the carriage and X and Y axes. If you haven't removed the print head and you notice the heater block is no longer square, it may have come loose.

Removal & Installation

This video shows how to completely remove and disconnect your print head. The video shows a V5 print head but V6 is the same. <https://www.youtube.com/watch?v=fplcCHhEf5w>

9.6.Feed Gear

Every time you change spools of filament, check the teeth of the gear for debris and clean as necessary. Use a toothbrush or firm bristle brush to completely remove all debris from the teeth.

10. Further Support

Please contact Support@Fusion3Design.com for further support. We like to start all support issues with email, and escalate to phone or video chat if needed.

11. Glossary

LCD	Liquid Crystal Display
LED	Light Emitting Diode
PSU	Power Supply Unit

APPENDIX A: Unpacking & Setup

This appendix is for our customers who had their F306 shipped to them.

Unpacking

Your F306 is shipped on a pallet inside a 3-piece box. This ensures your printer arrives undamaged and ready to print. Remember to save your packing materials in case you need to return your F306 to us. The box folds flat for easy storage.

Remove the banding straps or plastic wrap that holds the box onto the pallet.

Remove the lid of the box by lifting straight up.



Figure 50: Remove Box Lid

Around the top of the machine will be several white foam blocks that secure the printer in the box. Remove these by gently turning them sideways to disengage them from the frame and lift them straight out.



Figure 51: Top Foam Blocks

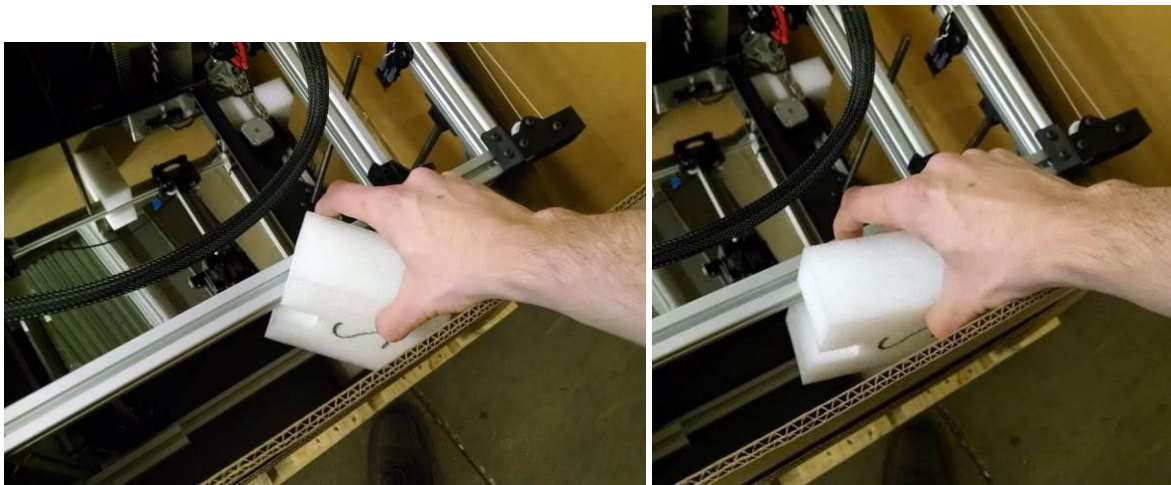

Figure 52: Removing Foam Blocks

Now you should be able to remove the sleeve from around the printer. Lift straight up, taking care not to hit the F306 as you lift. The sleeve folds flat for easy storage.

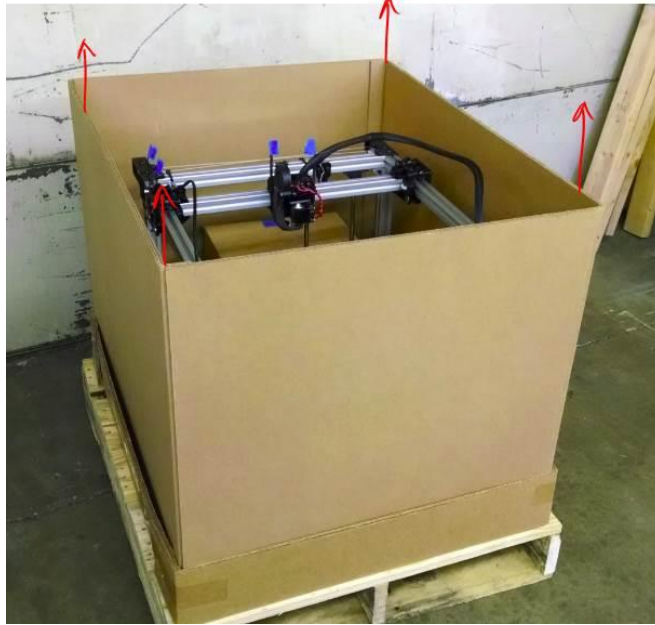

Figure 53: Remove Sleeve

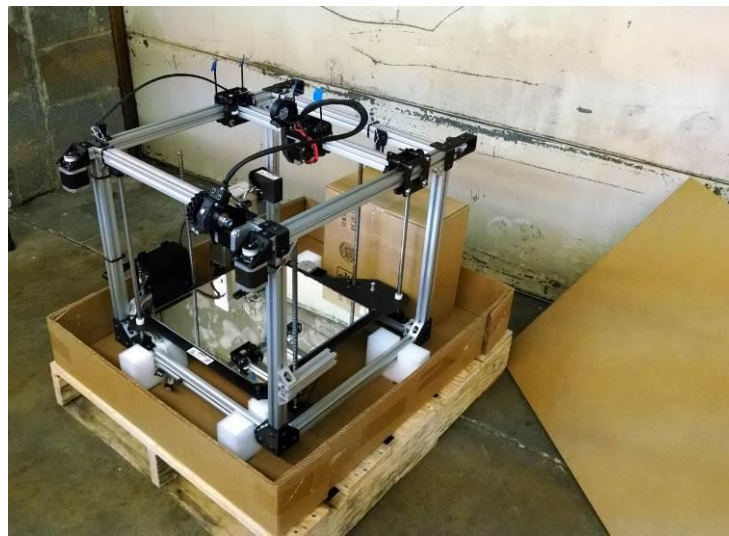

Figure 54: After Sleeve Removal

It's time to remove your F306 from the pallet! Carefully grasp it in the middle of the Y rails and lift it straight up to clear the foam blocks. Set it down on a firm, stable work surface. Refer to section 4.2 for lifting and carrying instructions.

Remove the small box from the cardboard tray. This is attached with spray adhesive to keep it from bouncing around during shipping. It should come loose with slight to moderate force. NOTE: There may be additional small boxes, depending on how much filament you ordered with your 3D printer.



Figure 55: Remove the small box

There is a spare print bed plate taped to the print bed with blue tape. Remove the tape and remove the spare plate.

Remove the zip ties that hold the X axis and print head in place. They are marked with blue tape. There are two on the left Y carriage and two on the X carriage.



Figure 56: Cut the zip ties flagged with blue tape (qty 4)

Open the small box and check the contents against the enclosed packing list.

Checking for Damage

Before powering your F306 up for the first time, thoroughly inspect it for damage. This section will cover the major things to look for, but keep an eye out for anything that looks abnormal anywhere on the machine. These sections should be done in the order they are listed below.

If anything does not behave as described, please contact support to resolve the problem BEFORE powering up your system.

Drive Cable Tension

Refer to Section 7.2.

XY Axes Motion

After you have checked the XY drive cables, you may very slowly move the X and Y axes through their full range of motion by hand to check that everything moves smoothly. Gently grasp the top of the X carriage as shown in section 4.2 and slowly move it through its entire range of motion in X and Y. You should feel little or no change in resistance or binding as you move the carriage.

IMPORTANT: Since we are moving the axes while the machine is off, it is extremely important that this step be done very slowly to avoid damaging the electronics!

X Crossbar Square

Refer to Section 7.3.

Check Print Bed

Check that the glass print surface is correctly captured under the corner clips and that the springs under the bed are correctly seated. Make sure the gap between the glass and the substrate is roughly the same at each corner.

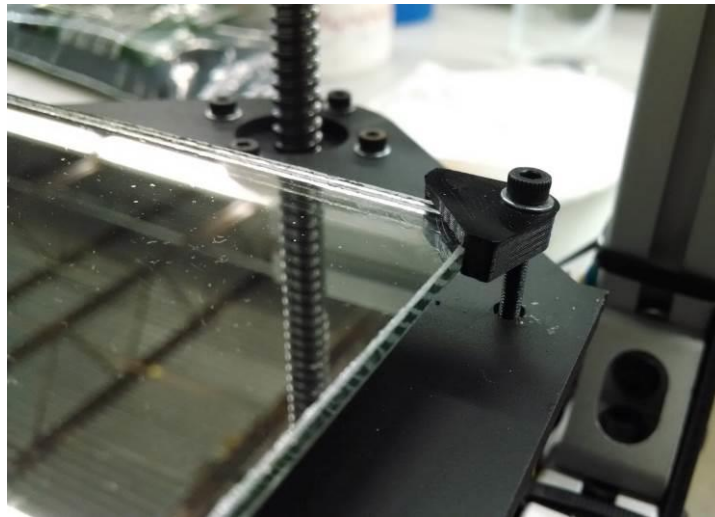

Figure 57: Bed corner clips should look like this

Power Up

Now we are ready to power up your F306 for the first time! Remove the power cord from its bag in the small box and plug it into the socket next to the power supply on the left side of the machine. Connect the other end to a 3-prong outlet.

When you flip the power switch, these things should happen:

- The internal PSU fan should begin spinning quietly.
- The white LED lights should come on.
- The screen should light up, and after a moment text should appear.
- A green LED should illuminate on the control board.
- The print head cooling fan should begin running.

IF ANY ONE OF THESE THINGS DOES NOT HAPPEN, POWER DOWN IMMEDIATELY AND CONTACT SUPPORT
(support@fusion3design.com)

Check Z Axis

With your **F306 powered up**, we can now check the Z axis for proper movement.

Reach underneath the print bed and grasp the Z axis belt with your hand. Slowly move the belt in the direction that lifts the bed up. Continue to move the belt by hand until the bed reaches the top of its travel. **Be careful not to collide with the print head!**

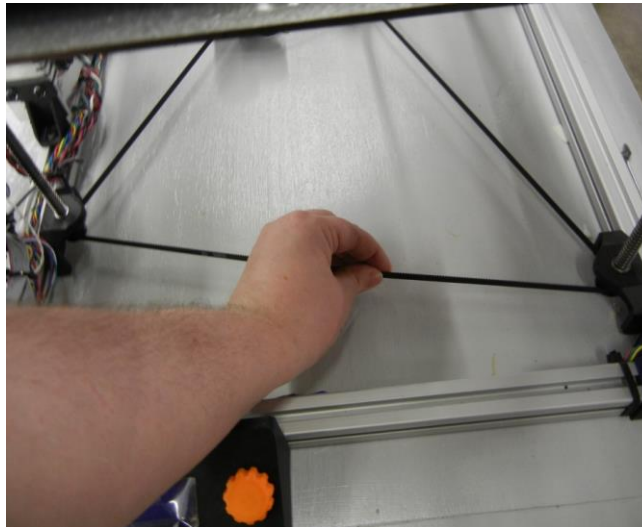

Figure 58: Moving the Z Axis by Hand

While you are doing this, watch for these things:

- The resistance of the belt to your movement should be consistent. You should not feel more than a small amount of “lumpiness” as the leadscrews rotate.
- The Z axis should not bind or suddenly become hard to move at any point. More resistance at the bottom of its range of travel is normal, with a gradual decrease as the bed moves up.

With the bed at the top of its travel, check the distance from the top of the adjacent beam to the steel plate near each leadscrew. This is easiest to do with calipers, as shown in the picture, but can be done with an accurate ruler such as a steel measuring scale. Do not measure this with a tape measure since the end of most tape measures can introduce measurement error. The distance should be equal within 0.2 mm of each other (less than 0.1 inches.)

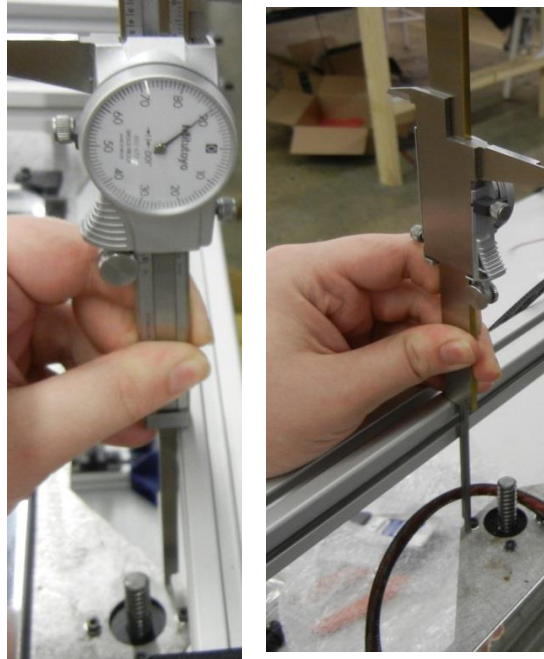

Figure 59: Checking Bed Substrate Level

If the platform is out of level, please contact support for assistance. An out of level platform possibly indicates rough treatment during shipping. We'll want to guide you through some additional checks by phone.

If the platform is level, congratulations! Your F306 is now set up and ready to go. Make sure you follow the bed leveling procedure (section 5.2) before attempting to print.

APPENDIX B: High-Precision Flow Rate Calibration

Each F306 is precision-calibrated at our factory before it's delivered to you. This calibration is generally accurate within 5% with most spools of material. However, for those times where you need parts as close to perfect as possible, the method described here will allow you to get the amount of extruded plastic perfect.

This method utilizes the included Filament Calibration Worksheet Excel file. There are basic instructions in that worksheet, as shown below.

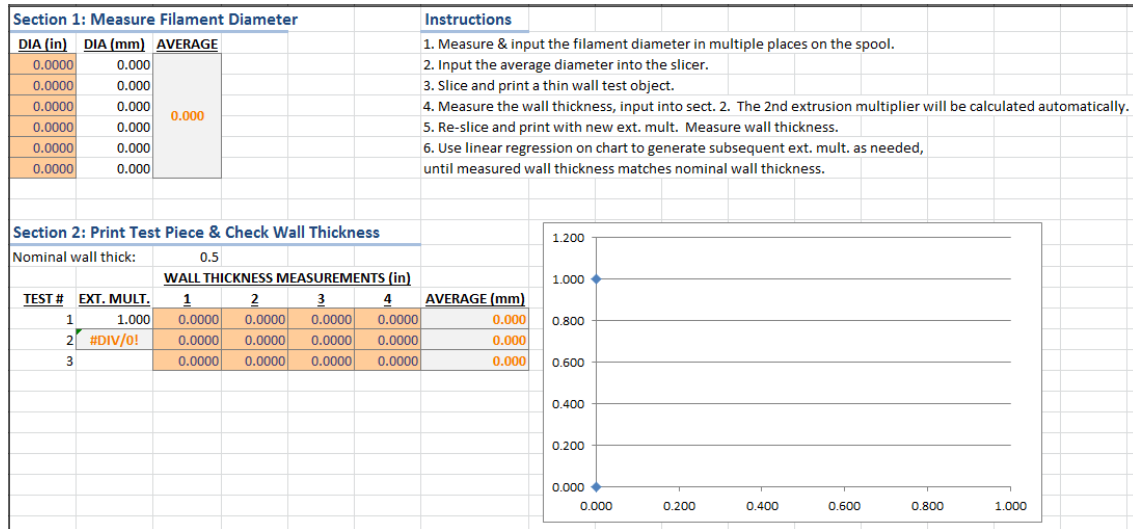

Figure 60: Filament Calibration Worksheet

First, make a new tab in the worksheet and copy the template to the new sheet. This way the template stays the same.

Step 1: Measure Filament Diameter

The first step is to measure the diameter of the filament as precisely as possible. The best technique is to take 3 or more pairs of measurements, with each pair being at 90 degrees to each other at roughly the same place on the spool, to capture any out-of-roundness in the filament. Take care not to crush the plastic with your calipers, as this will affect your measurements. If you are new to calipers, online resources such as YouTube can be helpful. Take measurements over as much of the spool as possible. You can use either metric or English calipers, and it will do the conversion to metric for you.



Figure 61: Measuring Filament Diameter

The spreadsheet will then calculate an average diameter, which you input into Simplify as shown below.

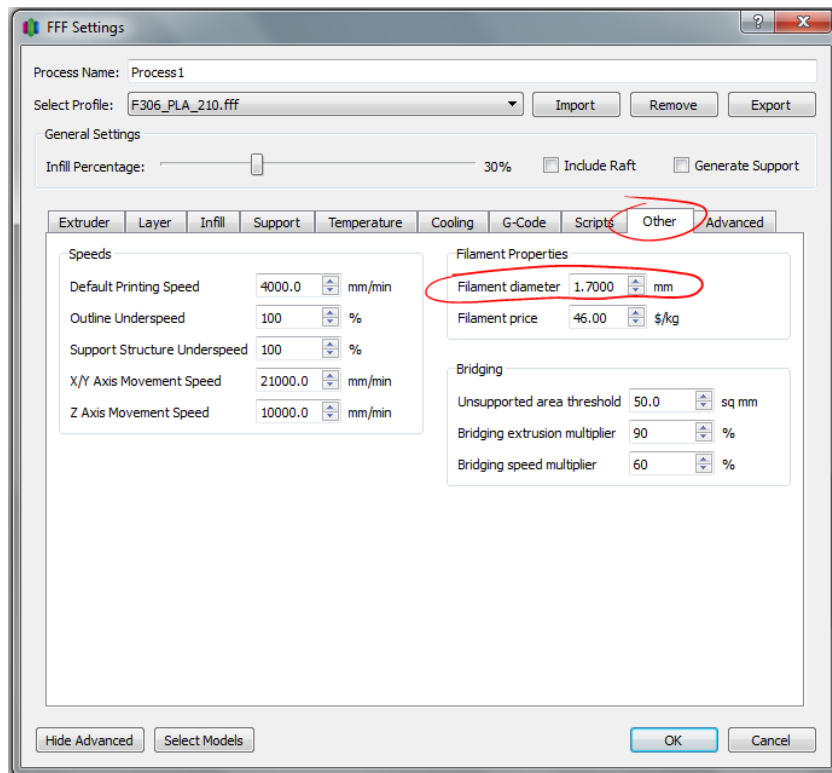

Figure 62: Input Filament Diameter

Step 2: Prepare test object

Next, set up Simplify to slice a simple object with the following settings:

- 1 bottom layer
- 0 top layers
- 0 infill

- 1 perimeter
- Make sure the “extrusion width” in Simplify matches that in the spreadsheet. It should be equal to or 0.05 larger than the nozzle size (currently 0.4mm.)
- We include a 40mm box that works well for this test.

Slice, save and transfer the file to your printer. Load the spool of material and run the part.

Step 3: Measure wall thickness

Now use the second half of the spreadsheet to measure the thickness of each of the 4 walls. The spreadsheet will calculate your average wall thickness and automatically compare it to the “nominal wall thickness,” a.k.a. what Simplify thinks the wall thickness is.

It is **extremely important** to use good measurement technique when measuring the wall thickness, as bad measurements will result in poor calibration. You want to grab only the top 3-6 layers in the jaws of the calipers, and use very light pressure so as not to crush the wall.

Once you input your 4 measurements, the spreadsheet will automatically calculate a corrected extrusion multiplier on the next line. Simply input this number into the process settings panel and re-slice and re-print the test part.

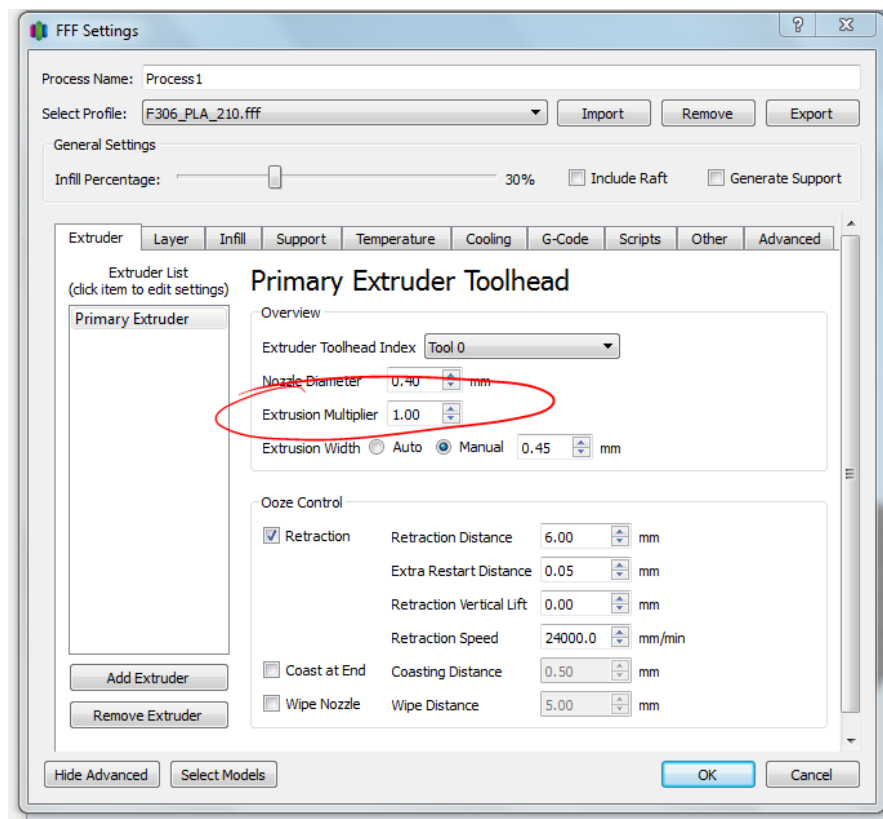

Figure 63: Input Extrusion Multiplier

Once you have printed and measured 2 test objects, you can set up the linear regression on the chart to more accurately estimate your correct extrusion multiplier. You’ll need to edit the plot data and select the correct tab in the spreadsheet. Excel seems to break the data links when you copy the template to a new tab. Then, your third extrusion multiplier is given by the regression equation displayed on the chart.

In general, you should be able to get within 1% of the correct flow rate with 3 trials.

APPENDIX C: Notes for Dual Extrusion Owners

This section outlines changes in the hardware, software and operation of your F306 if it is outfitted with a second print head. While dual extrusion does provide additional powerful capabilities, it is not as easy to use as single head machines.

Hardware Changes

Dual head systems consist of a second extruder unit mounted beside the first, as well as a slightly different print head design that carries 2 print heads and allows for the alignment of the heads. The additional extruder behaves exactly the same as the first. The print head assembly consists of 2 E3D V6 print heads, 2 blowers, and the print head bracket.

The primary extruder is called E0, and the secondary extruder is called E1. E0 is the left extruder and left print head.

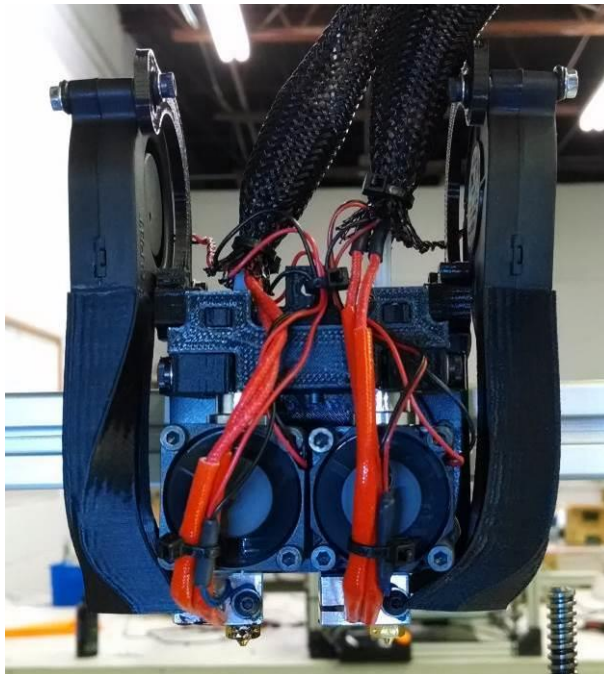

Figure 64: Dual Print Head

NOTE: The print heads have been precision-aligned at our factory. It is **EXTREMELY IMPORTANT** that you avoid bumping, pushing, or otherwise causing the print heads to become misaligned. If the print heads come out of alignment your dual-head prints will have an offset. Do not loosen or tighten the clamp bolts shown in the image below, as doing so may cause the print heads to become misaligned. Note that later versions of the F306 Dual look slightly different than this.

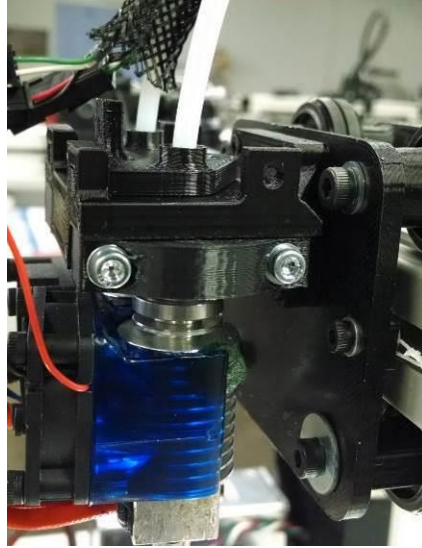

Figure 65: Print Head Clamp Bolts (blower removed for clarity)

The two centrifugal blowers are wired together, so both will operate at the same time.

Due to the layout of the print heads, it's normal to lose 20-25mm of travel in the Y direction. Your system's firmware has been updated to account for this shorter travel.

Your spool holder has been replaced with a longer one that can hold two spools side-by-side.

Software Changes

Firmware

Due to firmware differences compared to our single-head systems, your dual-extruder system does not have the "load filament" and "unload filament" options in the "Prepare" menu. Instead, we've prepared load and unload gcode scripts that reside on your SD card. There are 4 scripts in total: a load script for each print head, and an unload script for each print head. These work similarly to the scripts for the single head systems.

Simplify3D

Depending on what your goal is, there are a variety of ways to set up Simplify with your dual head F306. The most common uses are:

1. Object printed in material A, support material printed in material B. This is the most common use, and allows for the printing of highly complex models where using a single material for the part and the support structure is not practical.
2. A 2-color object, using the same material in different colors in each print head. This can look really cool, but requires a 2-piece model specifically designed for 2 color printing.
3. An object made out of 2 materials with different properties. For instance, this could allow a simulated overmold using a rubber-like material. This is not very common.

What we've done is provided Simplify configurations for cases 1 and 2. Now, because there are a very large number of combinations of possible materials and ways to set up Simplify, we didn't make a configuration for each

case. That being said, you should be able to build custom profiles as needed using the information in here and in the configurations.

Printing with Separate Support Material (option 1)

The profile for this setup is called “*F306_DUAL_ABS-HIPS.fff*.” This is set up to build the part out of ABS and the support structure out of HIPS. HIPS is soluble in limonene so it can be used as soluble support.

For example, let’s say you wanted to set up Bridge+HIPS. You’d need to copy this profile (and probably rename it) then examine the print settings for Bridge in the *F306_Bridge.fff* profile and copy the temperature and retraction settings over to the dual head profile.

If you want to do this same thing with PLA as the model material, you may need to find another support material. Since both materials will be printed at the same time, the glass transition temperatures of the materials need to be similar.

Printing in Multicolor (option 2)

There are two profiles needed for this setup. They are *F306_PLA_DUAL_Multicolor_0.fff* and *F306_PLA_DUAL_Multicolor_1.fff*. Simplify has a pretty good tutorial here:

<http://www.simplify3d.com/support/tutorials/printing-with-multiple-extruders/> You’ll need to scroll down to “workflow for 2 colors.”

Basically, you have 2 .STLs; one for each color. You add 2 printing processes in Simplify; assign the _0 profile to process 1 and the _1 profile to process 2. In process 1, you make sure only one .STL is selected. In process 2 you select the other .STL. When you click “prepare to print,” select “continuous printing” in the dialog box that pops up.

It can be a little hard to tell what’s going on in the toolpath preview. Ultimately, the best way to know if you have it set up correctly is to try printing.

If you wanted to do multicolor in another material, you’d copy these two profiles and put in the correct temperature, retraction, etc. settings.

Operational Changes

First, we strongly recommend you use your F306 as a single head printer for your first prints. This will allow you to become familiar with the system before adding the additional complexity of a second print head. The standard single-head Simplify profiles are fully compatible with your system. The second print head will merely not be used.

Loading Filament

Filament is loaded into the extruders normally. The spool for the left extruder (E0) should be mounted on the spool holder first, closest to the frame. The spool for E1 should be mounted towards the outside of the spool holder. This way, there is no crossover of the filament leading into the extruders.

Miscellaneous

Starting wipes need to be monitored more closely. With 2 heads there is a greater chance they will catch debris when starting the print. Also the starting wipe on a dual extrusion machine is going to be slightly farther back in Y since the Y endstop switch is mounted farther back.