

Rostock MAX v2 Assembly Guide



SeeMeCNC™
3D Printers & More

Welcome to the Assembly Guide for the Rostock MAX v2.0 3D printer.
Version 2.53, September 28th, 2016

Second Edition

Copyright 2015 by Gene Buckle

Licensed as Creative Commons Attribution-ShareAlike 3.0

Questions or corrections should be emailed to geneb@deltasoft.com



Read Me First!

This document is your instruction manual for your new SeeMeCNC® 3D printer machine. Before using your new 3D printer, thoroughly read and understand this manual for safe and effective operation of the machine.





Warning	
<p>Personal property damage, serious injury or death can result from not following instructions or warning in the manual or misuse of the machine.</p> <p>Automatic machine can start unexpectedly. Pay close attention and keep clear while power is connected to the machine</p>	
<p>Adult supervision required. Children under 18 years of age require supervision.</p>	
 <div style="border: 1px solid black; padding: 5px; width: fit-content;"> <p>⚠ DANGER Shock Hazard. Disconnect power before servicing. Improper use will result in serious injury or death.</p> </div>	<p>The machine power supply is connected to AC voltage and can be hazardous. Disconnect power before servicing this machine.</p>
 <div style="border: 1px solid black; padding: 5px; width: fit-content;"> <p>⚠ CAUTION: Hot Surface. Do NOT touch. Allow to cool before servicing.</p> </div>	<p>The hot end of the machine can reach very high temperatures of 700F and can cause serious burns. The heated print surfaces (heated bed) can also reach temperatures high enough to cause severe burns. Allow both to cool for 20 minutes after turning off power.</p>
 <div style="border: 1px solid black; padding: 5px; width: fit-content;"> <p>⚠ CAUTION: Pinch Point. Keep hands and fingers clear.</p> </div>	<p>Use caution near moving parts of the machine. Keep body and loose articles clear.</p>
	<p>Risk of Fire. Do not leave machine unattended.</p>
<p>Use genuine parts manufactured or designated by SeeMeCNC.</p> <p>Poisonous gas, smoke, or fumes could be emitted by some materials you could use with the machine. In such case, you should install ventilation.</p>	
	<p>Choking Hazard. This machine contains small parts and can produce small parts which can be a choking hazard to children.</p>
<p>Keep a copy of this manual near the machine, easily accessible to all operators.</p>	
<p>Use of this machine is at your own risk.</p>	
<p>Visit http://www.seemecnc.com to contact us if you have any questions.</p>	

Table of Contents

READ ME FIRST!.....	2
0 – Introduction and Acknowledgments.....	6
1 – Required Tools And Materials.....	8
2 – Visual Bill of Materials.....	11
3 – Prepping the Hot End and Power Supply.....	28
Preparing the Hot End.....	28
Preparing the Power Supply.....	33
4 – Building the Base.....	40
Installing The Feet.....	41
Preparing the Vertical Supports.....	42
Installing the Vertical Supports and Power Supply.....	47
Installing the Drive Gears on the Stepper Motors.....	51
Assembling the Tower Supports.....	54
Installing the Base Top Plate.....	62
5 – Installing the Onyx Heated Bed.....	66
Installing the Thermistor, Power LED and Power Wires.....	66
Mounting the Onyx Heated Bed to the Base.....	75
6 – Installing the Towers & Tower Wiring.....	79
Running Wire in the Towers.....	79
Setting the Towers.....	87
7 – Assembling, Installing, and Wiring the Top Section.....	91
Prepping the Upper Tower Mounts.....	92
Installing the Upper Tower Mounts.....	93
Installing the End Stop Switches.....	96
Installing the Upper Tower Mounting Hardware.....	98
Installing the Upper Idler Bearings.....	99
A little prep work is in order.....	100
Attaching the Top Plate.....	101
Connecting the End Stop Switches.....	105
Routing the wires & binding them.....	107
Tightening the Towers.....	113
8 – Assembling and Installing the Cheapskate Carriages.....	116
Assembling the Cheapskate Rollers.....	116
Assembling the U-Joint Carriers.....	118
Installing the U-Joint Axles.....	121
Installing the Belt Clip T-Nuts.....	122
Assembling and Installing the Cheapskate Carriages.....	123
Adjusting the Cheapskate Carriages.....	126
9 – Installing the Drive Belts.....	127
Belt Routing.....	127

Rostock MAX v2 Assembly Guide

Installing the Belt Clamps.....	131
Adjusting the Belt Tension.....	133
10 – Assembling and Installing the EZStruder.....	136
Assembling the EZStruder.....	136
Installing & Mounting the EZStruder.....	140
Wiring the EZStruder Stepper Motor.....	146
11 – Installing the Hot End and Bowden Tube.....	149
Preparing the Hot End Wiring.....	149
Wiring the Hot End.....	152
Attaching the Hot End to the Hot End Mounting Plate.....	155
Installing the Bowden Tube.....	157
12 – Installing the Effector Platform and Delta Arms.....	159
Assembling the Effector Platform.....	159
Installing the Delta Arms.....	161
Attaching the Effector Platform.....	164
13 – Installing the Hot End.....	166
14 – Finishing the Top End.....	168
Installing the Spool Holder.....	168
Installing the Top Plate and Spool Support Arm.....	172
15 – Assembling & Installing the LCD Panel Mount.....	176
Assembling the Front Panel.....	176
Installing the LCD Trim Panels.....	179
16 – Installing & Connecting the RAMBo Controller.....	182
Preparing the RAMBo Mounting Plate.....	182
Mounting the RAMBo Controller.....	184
Wire Prep: End Stops.....	186
Wire Prep: The Hot End Thermistor Connector.....	188
Wire Prep: The Heated End Thermistor Connector.....	189
Wire Prep: Extruder Motor Connector.....	190
Wiring the RAMBo Controller – Terminal Block.....	191
Plugging cabling into the RAMBo.....	193
Installing the RAMBo Into The Machine Base.....	196
Installing the Power Switch and LCD Controller Cables.....	197
17 – Final Assembly Tasks.....	200
Attaching the Base Covers & LCD Panel.....	200
Attaching the Power and USB Cables.....	203
Installing the Acrylic Cover Panels.....	205
Dem Feet!.....	207
Installing the Borosilicate Glass Build Plate.....	208
Smoke Test!.....	210
18 – Driver and Software Installation.....	211
Installing the RAMBo Driver.....	211
Installing the Arduino IDE.....	213
Configuring the Arduino IDE.....	214
Test Upload.....	215

Rostock MAX v2 Assembly Guide

Uploading Repetier-Firmware.....	217
The LCD and Front Panel Controls.....	219
19 – Installing MatterControl and Calibrating the Printer.....	222
Downloading, Installing, and Configuring MatterControl.....	222
Initial Function Tests.....	229
Optimizing The Temperature Control Algorithms.....	234
Setting the Z Height.....	238
Adjusting The End-Stops.....	239
Verifying Extruder Stepper Operation.....	244
Extruder Calibration.....	245
20 – First Print: PEEK Fan Shroud.....	246
Configuring the Slicer.....	246
Printing The PEEK Fan Shroud.....	250
Loading Filament.....	251
Preparing the Heated Bed.....	252
Printing the PEEK Fan Shroud.....	253
Installing the PEEK Fan and Shroud.....	255
21 – Second Print: Layer Fan Shroud.....	259
Appendix A: Maintenance and Troubleshooting.....	262
Print Layer Issues.....	263
Machine Won't Move!.....	265
Belt Damage or The Delta Arm Blues!.....	265

0 – Introduction and Acknowledgments

I'd like to welcome you to the second edition of the Rostock MAX v2 assembly guide!

Even if you've built an original Rostock MAX v1 3D printer, you'll want to read this manual carefully. There are no common Melamine parts from the v1 design. The construction has been greatly streamlined and should prove to be a shorter build. The design changes made will ensure that you've got a long lasting, easy to calibrate, delta configuration 3D printer.

Please read this entire guide before you begin assembly of your new Rostock MAX v2! It will help you avoid any unpleasant surprises and will ensure that you've got everything you need BEFORE you need it! Understand that the photographs in this assembly guide do NOT tell the whole story of each step! Make sure you read and understand the accompanying text for each step!

A quick note on the RAMBo, the controller for your Rostock MAX. The RAMBo is static sensitive, so please don't take it out of the static bag it ships in until you're ready to use it.

The box containing the RAMBo and its wiring should also contain a printed, black & white sheet that looks like this:

<http://www.reprap.org/wiki/File:Rambo-conn-all.jpg>

Please refer to this sheet when you reach Chapter 18. This is a valuable guide to wiring the RAMBo up to your Rostock MAX. Note that the connector polarity is clearly marked on the board for the "MOSFET Outputs".

Making Crimped Connections

Towards the end of the build, you'll be required to apply four crimp on sockets to the extruder wire extension. Teaching you how to properly crimp a connector is beyond the scope of this manual. However, that being said, I've done a lot of research on this in order to make this task as easy and accessible as I can. Chris Hansen over at Hansen Hobbies has written the most excellent treatise on the use of inexpensive crimp tools that I've yet seen. You can download the PDF of the tutorial here:

<http://www.hansenhobbies.com/products/connectors/Connectors.pdf>

The focus on the tutorial is on connectors commonly found on R/C servos, but the crimp sockets featured are essentially identical to those that you'll be required to use during your Rostock MAX v2 Build.

Rostock MAX v2 Assembly Guide

Acknowledgments

I'd like to thank the gentleman that runs <http://minow.blogspot.com.au/> for his excellent guide on calibrating delta configuration 3D printers.

I'd also like to thank the whole gang over at the SeeMeCNC forums for providing excellent feedback. This would be a much lesser creation without their contributions and insights.

1 – Required Tools And Materials

Before you begin assembly of your Rostock MAX v2, please make sure you've got everything on the following list of tools and additional materials.

- P1 & P2 sized Phillips screwdrivers
- Standard flat head screwdriver
- A small flat head screwdriver.
- 3/32" Allen (hex) wrench. A ball-end, T-handle version is a good choice for this and the other sizes of Allen wrenches used
- 5/32" Allen (hex) wrench.
- 7/64" Allen (hex) wrench.
- Needle nose pliers
- Slip joint pliers
- Forceps – these will come in handy when routing the belts and reaching for small, hard to reach parts. They can be purchased from Amazon for as little as \$3.50 for a set of two.



- Wire strippers
- Wire cutters
- 5/16" open-ended wrench (Used primarily on the nuts that hold the Cheapskates together)
- 2 7/16" open end wrenches. (used to adjust Cheapskate Bearings)
- 11/16" open-ended wrench (used for hot-end mount)

Rostock MAX v2 Assembly Guide

- PermaTex Ultra Copper High Temp RTV



- A small razor knife like an X-Acto knife. This will be handy for cleaning the flashing off the injection molded parts.
- 1/2” wide roll of Kapton tape
- A digital caliper. These can be purchased from Harbor Freight tools for around \$10.



- A small squeeze clamp that can open at least 6”
- Battery powered screwdriver. If you ever needed an excuse to buy one of these, THIS IS IT.
- Pencil.
- 40W Soldering Iron.
- Blue thread locking compound (Loctite or Permatex Threadlocker Blue)
- A small file.
- Elmer's Glue Stick – must be marked “Disappearing Purple”.
- Toothpicks
- Isopropyl Alcohol
- 12” framing square.
- 1 Roll of ABS filament. Needed to print the fan shrouds at the end of the build.

Rostock MAX v2 Assembly Guide

The following is a list of **optional** things that can make your life easier in the long run.

- Electrician's tape.
- Standard sized nylon wire ties.
- Waxed lacing cord. You can use this in place of wire ties in pretty much any application. You can find it here: <http://www.skygeek.com/wht-string.html>. While expensive, you'll never really need to buy a wire tie again and it'll likely last you the rest of your life. :)

I'd also recommend a little plastic box with part compartments in it. They're really cheap at craft stores and are perfect for building a kit like this – you can store all the various fasteners and have them ready to go as you need them. Here's the one I use for my various projects:



2 – Visual Bill of Materials

The Rostock MAX v2 kit shipping box should contain the following items:

- Four Melamine laser cut part sheets
- 1 Acrylic Parts Package
- 1 Power Supply
- 1 Hardware Box



Fig. 1-1: Shipping box contents.

If you're planning on painting your Rostock MAX v2, especially the part edges, you would be well served to carefully trace the outline of each part with a razor knife in order to cut the supporting masking tape. This way you can retain the protective mask on the parts in order to make painting the edges easier. Otherwise you'll have to re-apply a mask to avoid getting paint on the Melamine surfaces of the parts.

Rostock MAX v2 Assembly Guide

The Melamine parts are covered with a special cutting mask that prevents the laser cutting operation from depositing cutting byproducts on the Melamine surface. You'll need to remove all of this material before beginning construction.

This process is called the Five Stages of Masking Tape.

1. Denial - Oh there's no way I need to scrape all this tape off those parts? Do I?
2. Anger - @\$%@#! This sucks! I've NEVER SEEN SO MUCH TAPE IN ONE PLACE IN MY LIFE!
3. Bargaining - "Well hi there, Significant Other! Would you PLEASE remove all this tape for me? PLEASE?"
4. Depression - This tape hates me. *sobs quietly*
5. Acceptance - Well I suppose if I'm ever going to get this thing built, I'd better get on with it and get all this tape removed...*sigh*

Ok, it's not THAT bad, it just seems like it. It beats having sticky residue all over your nice and clean Melamine parts. :)

You'll notice that there's a few strips of 2" wide masking to remove as well. This tape holds the parts in the sheets so they're not damaged during shipping. I recommend removing this tape FIRST.

Take special care when removing the laser cut parts from the sheets. Sometimes the laser doesn't quite cut all the way through. If you find a part like this, you'll want to gently score the back side of the sheet along the faint cut line and then press the part out from the front of the sheet. The front and back of the sheet is easily identifiable – the front of the sheet will have very dark laser cut lines with "flash" deposits to either side of the laser cut line. The back of the sheet will have much fainter marks.

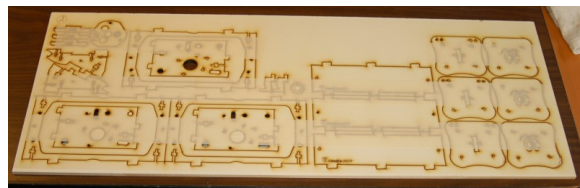
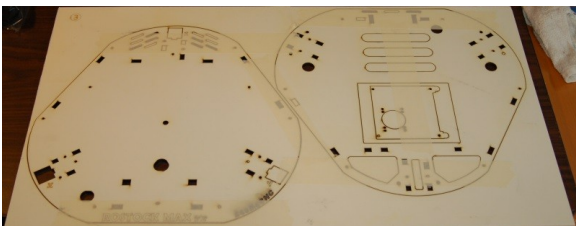
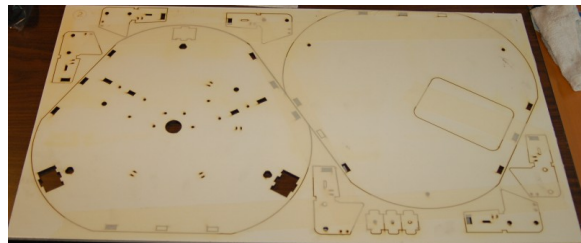
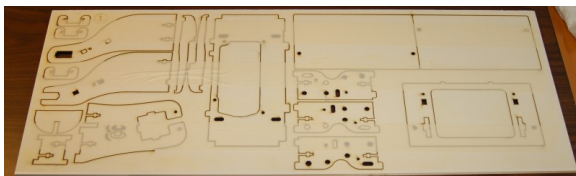

Rostock MAX v2 Assembly Guide

The white cardboard box will contain the laser cut Acrylic parts that are used in the build.

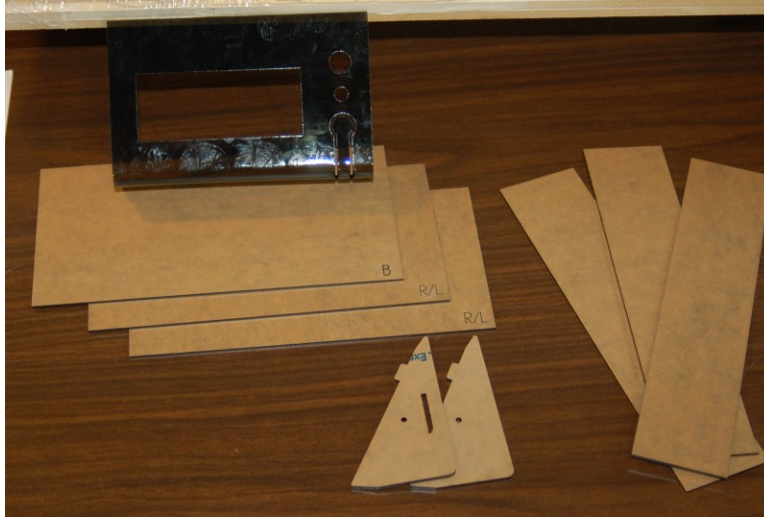

Fig. 1-2: Acrylic parts.

The Acrylic parts have a paper protective covering on them. Please leave that in place until you're ready to install them.

The large cardboard box contains the hardware & electronic components required to build the Rostock MAX v2. Many are in individual baggies, some are in heat-sealed bag “packs”. As you go through the following Bill of Materials, please count and check off each item. This is important as you don't want to be short a vital part during the build. It's better to find out before hand than being forced to stop the assembly process due to a missing part. If you are missing any parts, please contact support@seemecnc.com with the subject line of “Missing Parts!”.



Fig 1-3: Hardware & Electronic components.

Rostock MAX v2 Assembly Guide

For those that aren't sure how to identify the various screw types, Bolt Depot has made available some *excellent* references. I would recommend Fastener Basics (<http://www.boltdepot.com/fastener-information/Printable-Tools/Fastener-Basics.pdf>) and their Fastener Type Chart (<http://www.boltdepot.com/fastener-information/Type-Chart.aspx>).

Let's go ahead and do an inventory of the parts to ensure that you're not missing anything! Please check off each item as you locate it. Where possible, I'll include the SeeMeCNC part number enclosed in square brackets. Quantities are surrounded by parentheses.

Hardware Package #1



Rubber foot pack. Contains the following components:

(___) (6) #10-32, 5/8" Nylon Pan Head Screws [29998]

(___) (6) #10-32 Nylon Finish Nuts [30170]

(___) (6) Injection molded feet (black) [17505]

(___) (6) Soft rubber "shoes" [44010]



(___) (9) #10-32, 3/4" Knurled Nylon Thumb Screws. [30172]

These are for the right & left base covers as well as the LCD panel.



(___) (4) #6-32, 1/2" Slotted Pan Head Screws (Nylon). [30121]

These are used to mount the ATX power supply



(___) (31) #6-32, 1" Phillips Pan Head Screws. Used for general assembly. [30033]

Rostock MAX v2 Assembly Guide



(___) (6) #6-32, 5/8" Socket Head Cap Screws. Used for mounting the U-Joint carrier to the Cheapskate plates. [30006]



(___) (12) #6-32, 1-3/4" Phillips Pan Head Stainless Steel screws. Used for 608 idlers in the motor mounts as well as the hot end standoffs. [30034]



(___) (63) #6-32 Stainless Steel Nylon Lock Nut – covers all #6-32 screws. [30164]



(___) (14) #6-32, 2" Phillips Pan Head Stainless Steel screws. Used for Cheapskate plates and EZStruder mount. [30037]



(___) (15) #6-32, 1/2" 18-8 Stainless Steel Flathead screw. Used inside of base and top side plates, to retain acrylic panels and the three end-stop triggering screws installed in the Cheapskate U-Joint mounts. [30135]



(___) (25) #1/4-20, 1/2" Stainless Steel Button Head Cap Screws. Used for tower mounting. [30149]



(___) (25) #1/4-20 nut plates. Used for T-Slot mounting. [32005]

Rostock MAX v2 Assembly Guide

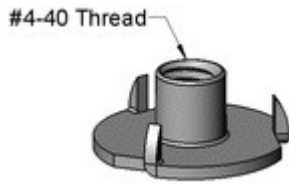

(___) (10) #4-40 T-Nuts. Used for belt clamps and RAMBo mounting. [30222]



(___) (4) #4-40, 3/4" Phillips Flat Head Machine screws. Used for mounting the RAMBo Controller. [30236]



(___) (6) #4-40, 1/2" Stainless Steel Socket Head Cap screws. Used for the belt clamps. [30232]



(___) (14) #2-56, 5/8" Pan Head Phillips Machine screws. Used for LCD mounting and end-stop switch mounting. [30650] (Combined Package)



(___) (14) 2-56 Finish Nuts. Used for LCD mounting and end-stop switch mounting. [30642] (Combined Package)



(___) 14 each, #4, 3/8" Phillips Pan Head Sheet Metal screws. Used for LCD sides and tower alignment stops. [30250]



(___) (12) M3x.5, 10mm Pan Head Machine screws. Used for mounting the stepper motors. [30318]

Rostock MAX v2 Assembly Guide



(___) (18) #6 Stainless Steel Flat washers. Used on the 608 bearings that go in the top & bottom T-Slot rails. [30450]



(___) (6) #4 Stainless Steel Flat washers. Used with the belt clamp screws. [30449]



(___) (21) 608ZZ Ball Bearings. Used in the Cheapskates and belt idlers. [35065]



(___) (1) #10-32, 5/8" Socket Head Cap Screw. Used as a tap for the #10-32 Nylon thumb screws. [29999]

Rostock MAX v2 Assembly Guide

Hardware Pack #2



(___) (18) 608 Cheapskate Idler Bearing Spacer. Used for belt idlers.
[68340]



(___) (12) 608 Cheapskate Carriage Bearing Spacers (black). [68326]

(___) (12) 608 Cheapskate Eccentric Bearing Spacers (gray). [68340]

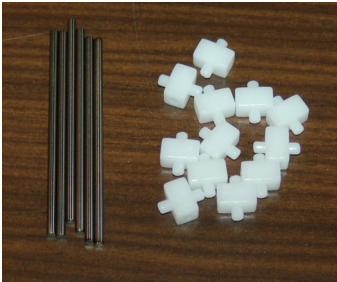

(___) (12) Universal Joints (Injection molded Acetal). [68309]

(___) (6) 3-1/8" Steel Universal Joint axle shafts. [68325]



(___) (3) 1" long machined aluminum hot end platform spacers. [68334]

Rostock MAX v2 Assembly Guide

Hardware Pack #3



(___) (20) Plastic Bearing Rollers. 4 are used for mounting the RAMBo and six are used for the belt clamps. [71505]



(___) (12) Small Wire Ties. Used for wire management or Barbie Handcuffs. Your call.



(___) (1) GT2 2mm pitch belt pulley pack. Includes six grub screws and hex wrench. [39835]



(___) (3) Carriage base for U-Joints. [68332]



(___) (1) Effector Platform. [70832]



(___) (6) U-Joint Spring Clips. [87940]

Rostock MAX v2 Assembly Guide

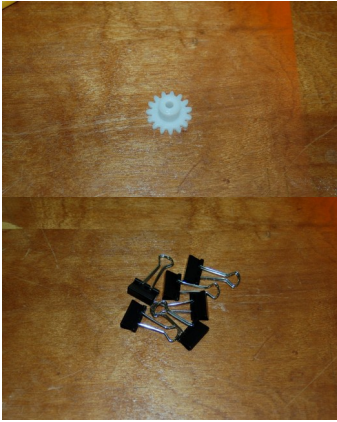

(___) (1) 15 Tooth Gear. Used for manually operating extruder motor.
[71566]

(___) (6) Binder Clips. Used to hold the Borosilicate glass build plate to
the Onyx heated bed. [58761]

Rostock MAX v2 Assembly Guide

Rostock MAX v2 Electronics and Hardware Pack #4



(___) (1) RAMBo Electronic Control Board with screw terminals and end stop wires. [84392]

(___) (1) USB Cable.



(___) (1) Onyx Heated Bed Kit.



(___) (1) LCD Smart Controller with SD card, LCD to RAMBo Adapter Kit and 1 Soft Touch 5mm knob.

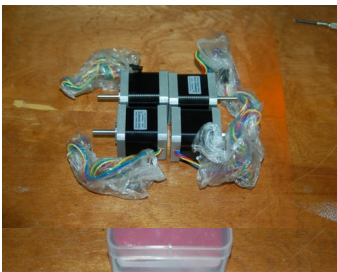

(___) (4) NEMA 17 Stepper Motors (4800cgm holding torque). Used for three motion axes and extruder drive.



(___) (1) Rocker switch, including spade lug crimp terminals.

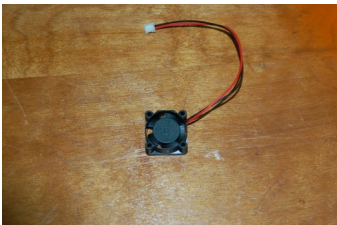

(___) (1) 25x25x10mm 12VDC fan. Used to cool the PEEK section on the hot end.

Rostock MAX v2 Assembly Guide

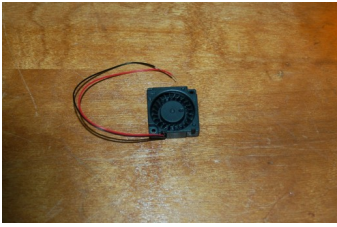

(___) (1) 30x30x10mm 12VDC fan. Used for part cooling.

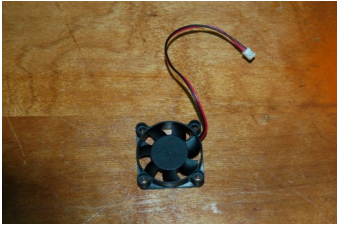

(___) (1) 40x40x10mm 12VDC fan. RAMBo cooling fan.



(___) 10 feet, 18ga, 4 conductor wire. Used for the hot end power and thermistor.



(___) 10 feet, 22ga, 4 conductor wire. Used to extend wiring for extruder motor.



(___) 15 feet, 26ga, Black & Red wire. Used for hot end PEEK and part fans.



(___) 4 feet, 3/8" diameter Expandable Mesh Wire Loom (black). Used to cover wiring & bowden tube from the top to the hot end platform.
Includes 3" of 5/16" heat shrink tubing.



(___) (3) 76" GT2 Timing Belts.

Rostock MAX v2 Assembly Guide



(___) (24) Bearing Sleeves. Used to cover 608ZZ bearings.



(___) (6) Rostock MAX Delta Arms.



(___) (1) EZStruder Cold End Kit. Includes stepper motor mounting hardware.



(___) (1) Hot End Kit. Includes hot end, heating resistors, thermistor, PTFE sleeve for thermistor, PTC fittings and PTFE bowden tube.

Rostock MAX v2 Assembly Guide

Smoked Acrylic Parts Pack



(___) 1 each, Smoked Acrylic parts pack. Includes, LCD face, LCD sides (left & right), base and top covers.

Miscellaneous Parts



(___) (1) 300mm x 3mm Borosilicate Glass Build Plate. Used with Onyx Heated Bed. (Yes, there's a big glass disc inside that foam sleeve!)



(___) (1) ATX Power Supply.



(___) (3) T-Slot rail, 32" long. [68310]

Rostock MAX v2 Assembly Guide

Melamine Parts, Sheet #1

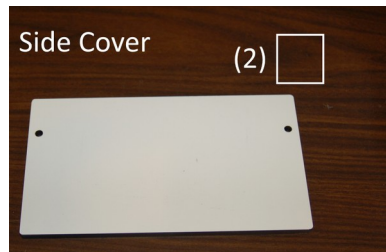
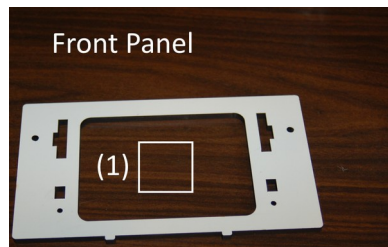
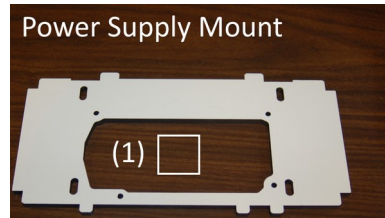
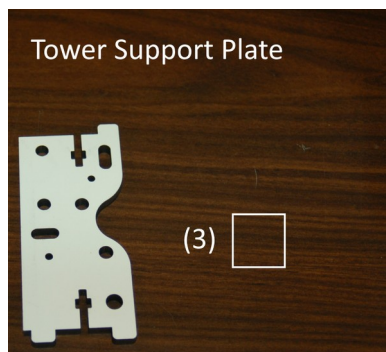
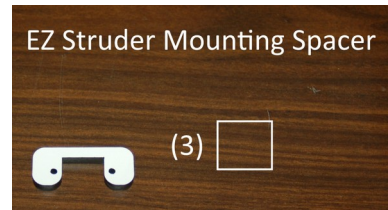
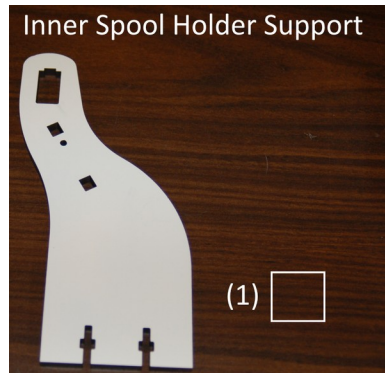
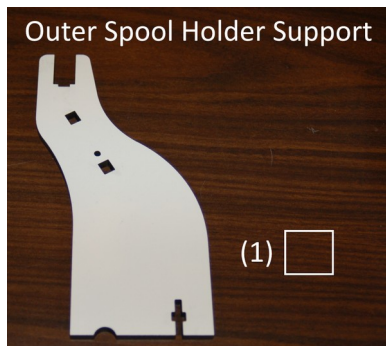
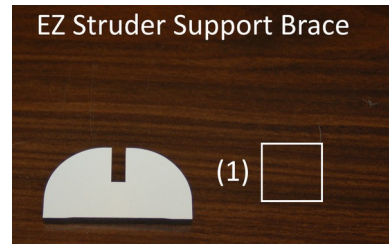
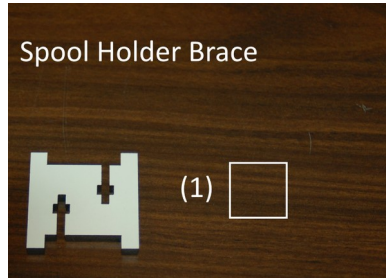
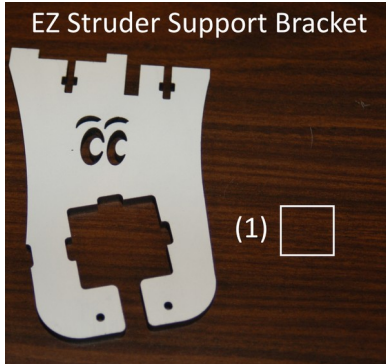

Rostock MAX v2 Assembly Guide

Melamine Parts, Sheet #2

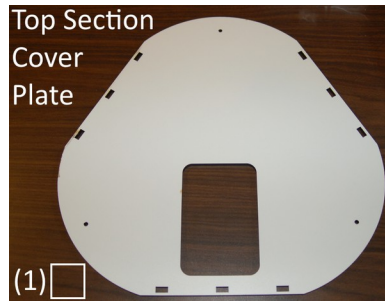
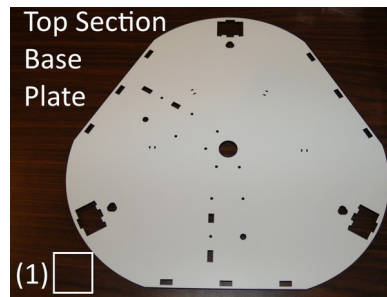
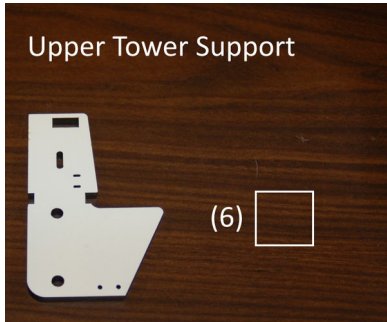

Melamine Parts, Sheet #3

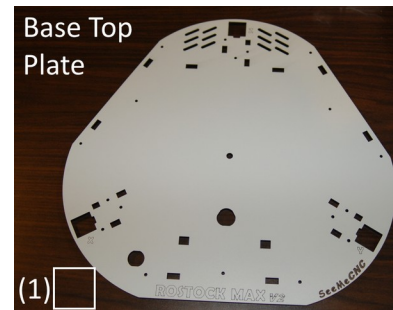
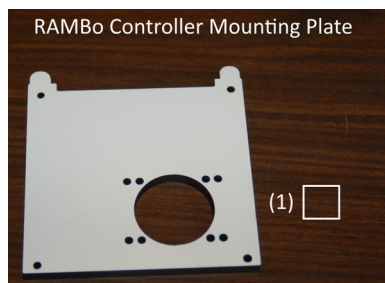
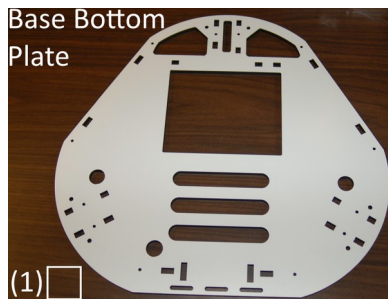

Rostock MAX v2 Assembly Guide

Melamine Parts, Sheet #4

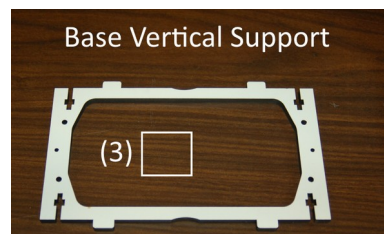
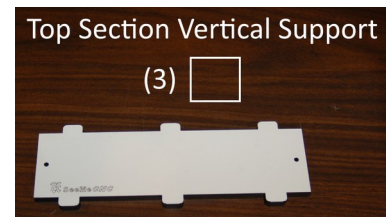
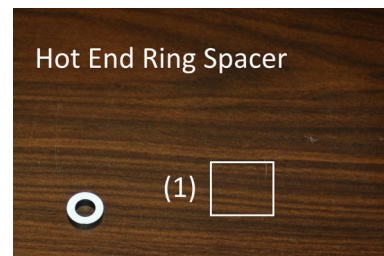
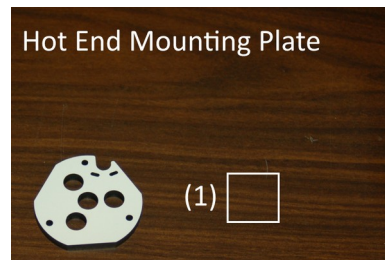
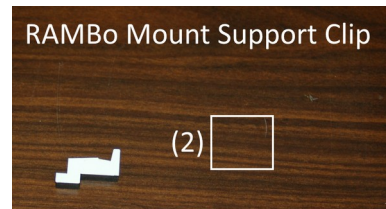
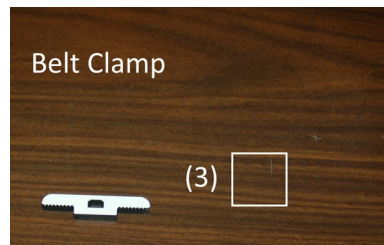
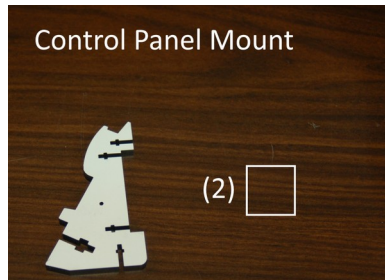
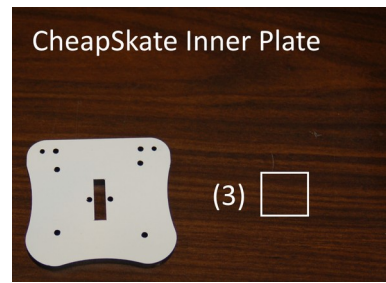
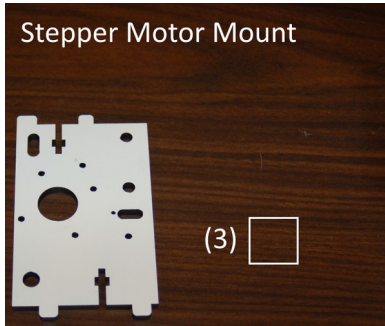

3 – Prepping the Hot End and Power Supply

Preparing the Hot End

For this task, you'll need the following components:



Hot End Pack

You'll also need the Permatex Copper RTV sealant as well as a few toothpicks.

The hot end for your Rostock MAX v2 3D printer uses Permatex Ultra Copper RTV to hold both the heating resistors and the temperature sensor (the thermistor) in place. Because it takes 24 hours for the RTV to set fully, it's a good idea to get that started now. The hot end will have to remain upright during the period that the RTV is curing. The simplest way to do this is to use the large white box the Acrylic parts are shipped in. Take the parts out of the box and using a pair of scissors, cut a “+” hole in the top by shoving the scissor blade straight in. Put the Acrylic parts back in the box and set it aside – we'll use it soon!

Before we start on this, I'd like to tighten the nozzle that's installed in the hot end. Grip the hot end by the heater block as shown below and gently tighten the nozzle with a 5/16” wrench.

Take care not to grip the sides of the heater block too tightly – you don't want to damage it.



Fig. 3-1: Tightening the nozzle.

Rostock MAX v2 Assembly Guide

For this step, you'll need the parts out of the hot end pack. This includes the hot end itself, the two heating resistors and the tiny pack with the thermistor and it's PTFE tubing.



Fig. 3-2: RTV & heating resistor.

You'll start by coating each heating resistor with RTV as shown in Fig. 3-3.

You'll want to try to keep the resistor leads free of RTV, but don't skimp on the RTV application. You can always clean off excess RTV after it's cured.



Fig. 3-3: Coating the heating resistor with RTV.

This stuff is goopy and sticks to everything! Keep a paper towel or ten handy.

Rostock MAX v2 Assembly Guide

Carefully insert both heating resistors into the pockets in the hot end as shown in Fig. 3-4.

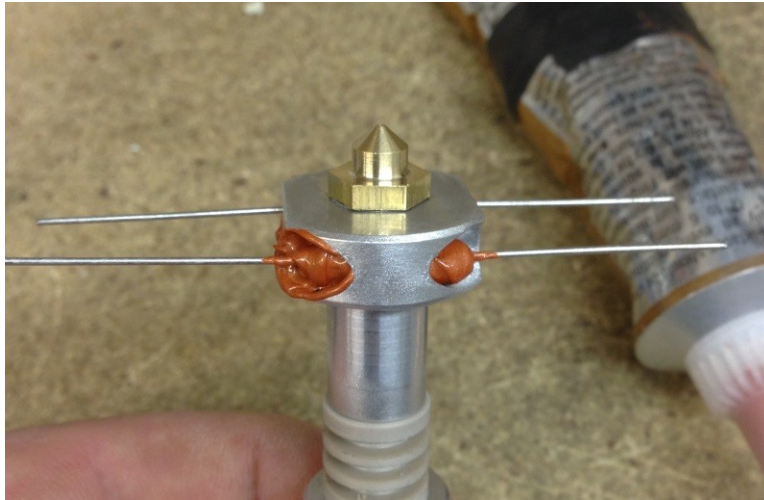

Fig. 3-4: Resistors installed in the hot end.

You'll need to add a little more RTV to both ends of the resistor in order to fully fill the cavity that the resistors sit in. Use a toothpick to help pack the RTV in. You don't want any air pockets in there. Air pockets can shorten the life of the resistors because air exposure will allow the resistor to over-heat in a single area.

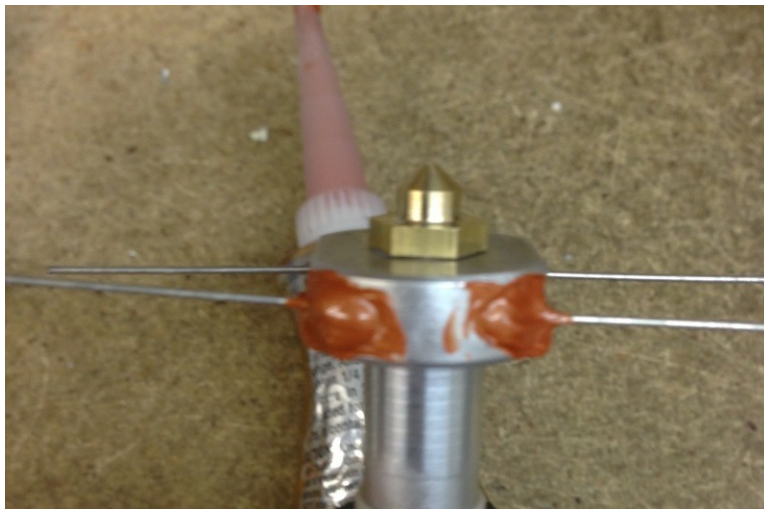

Fig. 3-5: Resistor cavities filled with RTV.

Don't be surprised if your application of RTV is not nearly as neat as shown above. These hot end assembly photos were shot by Andy Oprisko, a SeeMeCNC employee. He's literally built hundreds of hot ends and is very, very good at it.

Rostock MAX v2 Assembly Guide

Set the hot end aside, with the nozzle pointing up. We're going to prep the thermistor for installation next.

Take the short length of PTFE tubing from the thermistor package and cut it in half. Trim each half so it's about 1-1/4" long. Remove the thermistor from the paper protector (aka The Post-It! Of Shielding) and slide the a PTFE tube on to each of the thermistor leads as shown below.



Fig. 3-6: Thermistor with PTFE sleeves installed.

Using a pair of needle nosed pliers, bend a 90 degree angle in the thermistor and PTFE tubing as shown below. Take special care to not damage the thermistor head! It's made of glass and is very delicate.



Fig. 3-7: Bending the thermistor.

Take the nozzle off the Permatex Ultra Copper RTV tube and dip the end of the thermistor into the RTV as shown below.



Fig. 3-8: Coating the thermistor with RTV.

Rostock MAX v2 Assembly Guide

The thermistor should now be installed in the thermistor port on the flatted side of the hot end as shown. Set it aside in a safe place to allow the RTV to cure.

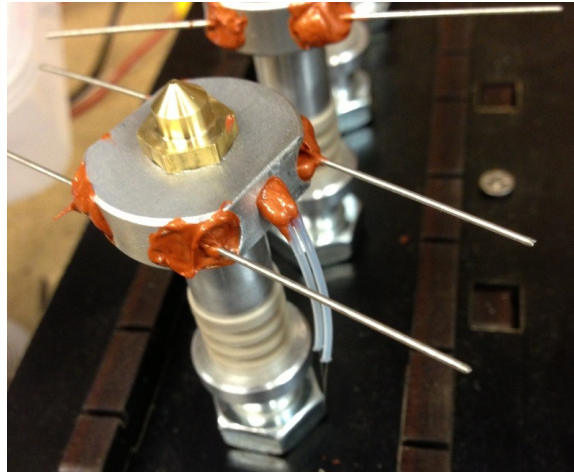

Fig. 3-9: Thermistor installed.

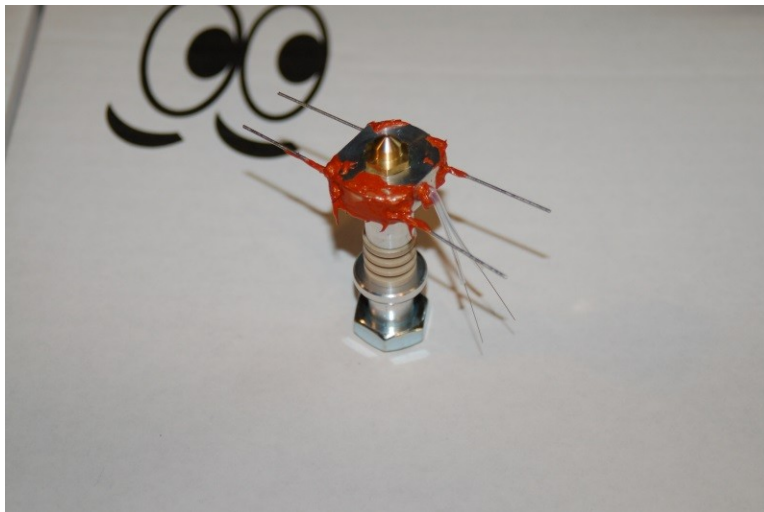

Fig. 3-10: Hot end plugged into the cardboard box for curing.

Preparing the Power Supply

For this task, you'll need these components:



Power Supply



Power Switch Pack



RAMBo Box

Your Rostock MAX v2 uses a standard ATX computer power supply to provide power to the RAMBo controller, the Onyx heated bed and the hot-end. All of these components require 12V DC. The 12V wires on an ATX power supply are yellow. You'll need four of these for the heated bed power, and one each for the hot-end and motors. Each yellow wire must be accompanied by a ground (black) wire, so you'll need six black wires in addition to the six yellow.

The heated bed terminal requires four wires because the Onyx draws a lot of power – more than a single wire can supply. Think of each wire as a water hose. For a given diameter of hose, you can only deliver so much water at a time. However, if you use FOUR hoses, you can deliver four times the volume. In our case “volume” is “amperes” (the “water pressure” is volts). So using four wires gives us four times the amps that a single wire can deliver. Understand that if you try to draw too much through a single wire, the electrons inside the wire basically get into a fight with each other, all trying to escape through the same tiny hole at once. All this combat generates heat. As the heat increases, the ability of the wire to carry this current decreases. The hotter it gets, the worse the problem gets until something gives up. Usually the “give up” point happens with a melted connector and a dead RAMBo.

The first thing we're going to do is locate the power-on wires that are on the main ATX connector. We're looking for a green wire and a matching black wire as shown. [By shorting the green & black wires together via a switch, it causes the ATX power supply to turn on.]

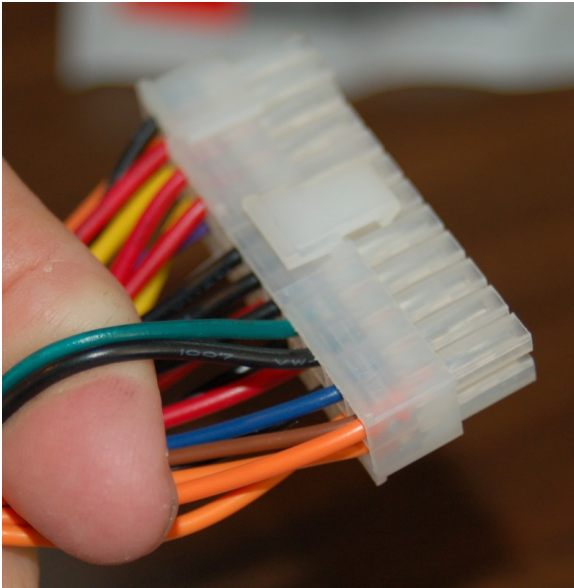

Fig. 3-11: Isolating the green & black wires.

Once you've isolated the green & black wires on the main ATX connector, go ahead and cut them free of the connector as shown below.

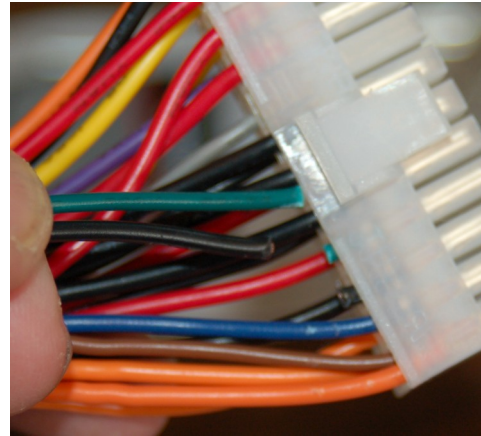

Fig. 3-12: Wires cut free.

DO NOT REMOVE THE ENTIRE ATX CONNECTOR. ONLY REMOVE THE WIRES SHOWN.

Free the green & black wires from the rest of the wiring bundle. You can spin them into a loop to get them out of your way or bundle them together with waxed lacing cord as I show below.

Using lacing cord like this is pretty simple and a lot less expensive than using nylon wire ties in the long run. *This is strictly my personal preference!* You're under no obligation as a builder to do this yourself. I'm just a bit...driven about what my wiring looks like. 😊

The simplest way to get the four wire pairs needed for the heated bed is to grab a connector that's already got them grouped for us. Look through the wiring bundle until you find a connector bundle that looks like what is shown in Fig. 3-15A. It may also be split apart and look like what's in Fig. 3-15B.

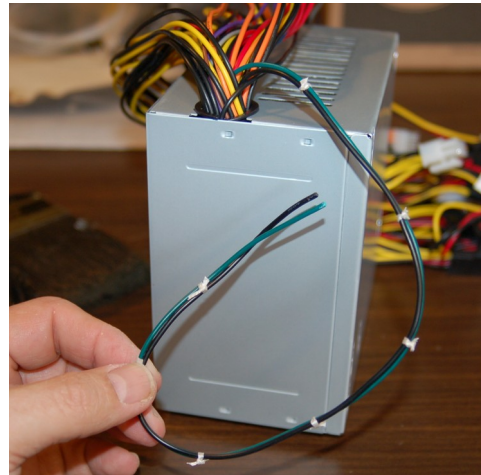

You may be tempted to “tin” the bare leads of the wires. Do not do this. The tinned lead will prevent the compression terminal from properly “squashing” the wire (and thus getting a good, broad contact surface). This can (and likely will) result in a spot heat build-up that will ruin one or more of the compression terminal positions. This holds true for ALL compression terminal wiring in the Rostock MAX v2 kit!

Rostock MAX v2 Assembly Guide

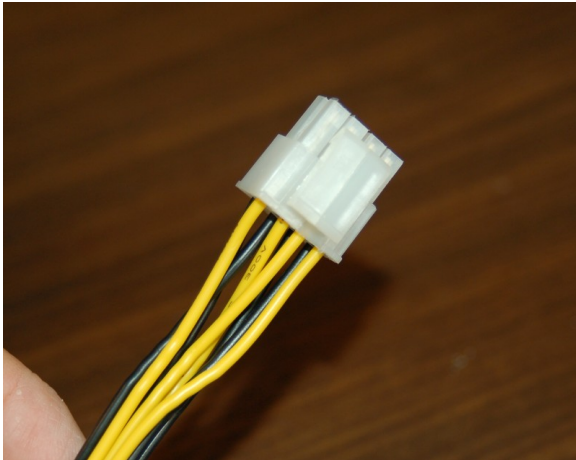

Fig. 3-15A: 8 pin connector.

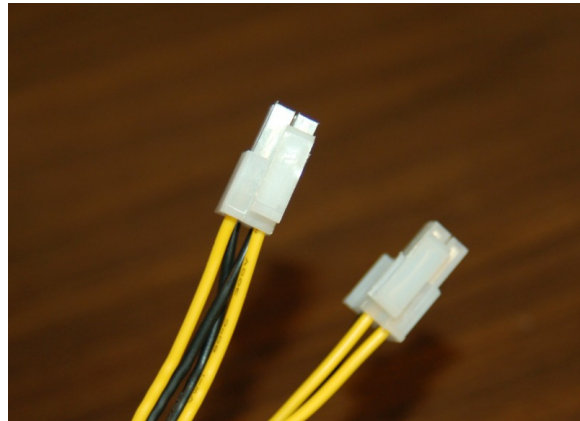

Fig. 3-15B: 8 pin connector, split.

Cut the connector off, flush with the wires – this gives you the most wire to work with. When you're done, bundle them up and set them aside.



Fig. 3-16: Heated bed power wires.

The RAMBo board needs two additional pair of yellow & black wires – we'll get those from the connector shown below.

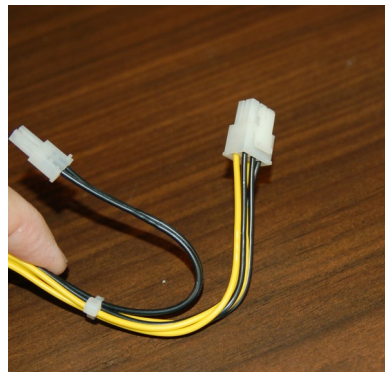

Fig. 3-17: Additional wires..

A few concerned builders have written me about the connectors (or lack of) that I show on this page and the next. The important parts are the yellow and black wires. It doesn't really matter WHERE you get them, so long as the wires you choose are long enough to do the job. How long is “long enough”? Well grab the bundle with the 8 pin connector on that and use that as the “base” length. If you don't have the 8 pin connector, find the longest yellow & black wire set on the power supply, match to the next longest, etc. Do this until you have the 6 black & yellow wires needed for the build.

Rostock MAX v2 Assembly Guide

Since we only need four of the six wires that are present on the connector, only cut those four free – leave the other two in place. It saves you the trouble of having to cover them with electrician's or Kapton tape to prevent them from shorting (in the case of the yellow wire).

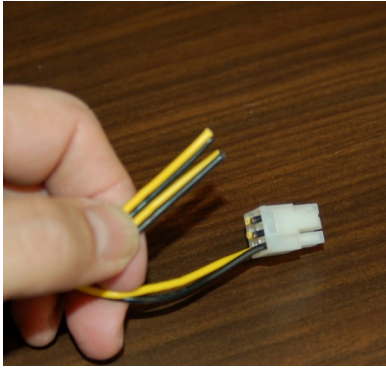

Fig. 3-18: Cut free.

Like you did with the four heater bed pairs, bundle them up or simply set them aside.

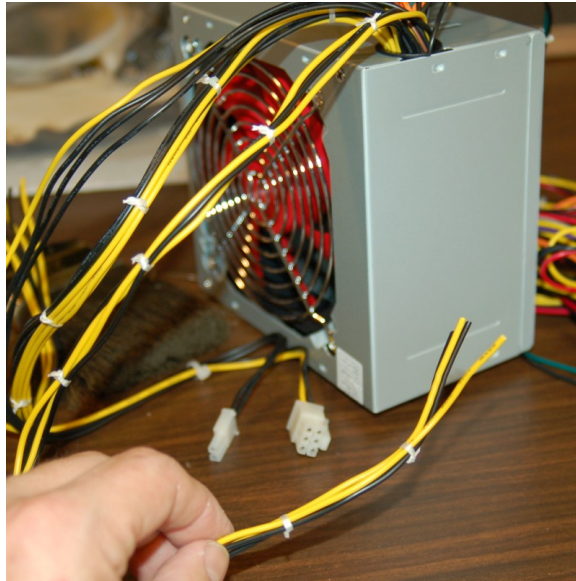

Fig. 3-19: Wires ready to use.

Rostock MAX v2 Assembly Guide

Before we add the RAMBo connector to the wires we just cut free of the power supply, now would be a good time to neaten up the remaining wiring that won't be used. Using a regular wire tie (you'll need to supply this!) bundle up the unused wiring and then use another to bind the bundle to the power supply as shown below.

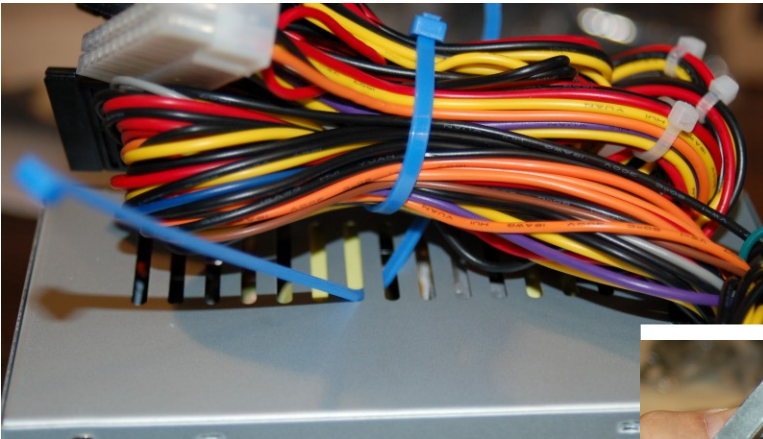

Fig. 3-20: Routing the wire tie through a vent.

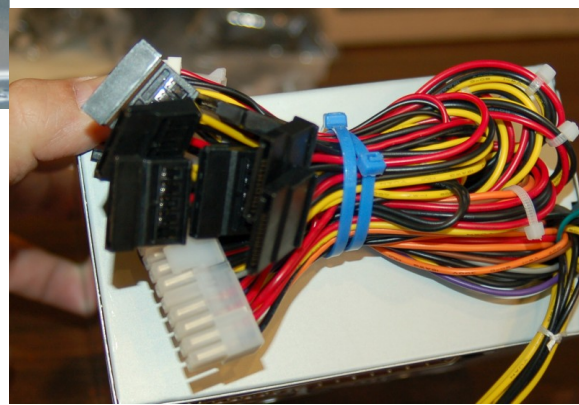

Fig. 3-21: All done!

Now you'll need to locate the RAMBo power connector – this is a six position compression terminal block and will be found in the little zip lock baggie that's in the RAMBo box.



Fig. 3-22: RAMBo power connector.

Rostock MAX v2 Assembly Guide

Grab the four-pair bundle of wires and strip off about 1/2" of insulation from each wire. When you're done, you should have all eight stripped like so:

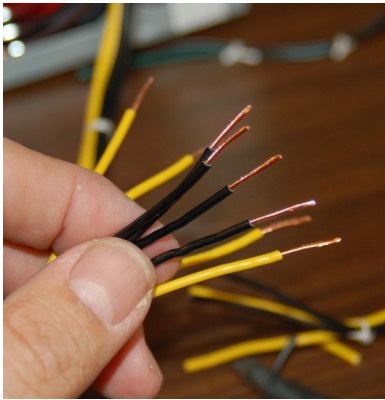

Fig. 3-23: Wires stripped.

Now take the four black wires and spindle them into a bundle as shown below in Fig. 3-24. Repeat that process for the yellow wires.

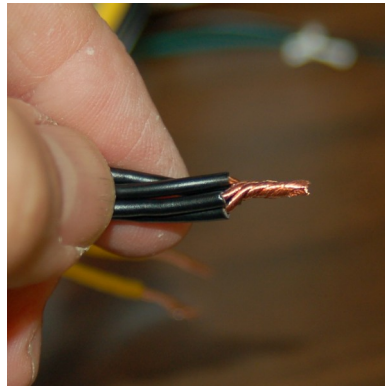

Fig. 3-24: Grounds bundled.

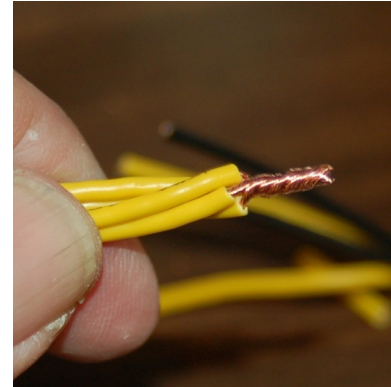

Fig. 3-25: Primaries bundled.

Now you'll insert the bundled black & yellow wires into the RAMBo power connector **EXACTLY AS SHOWN**. The terminal posts tighten down with a small, flat bladed screwdriver. The terminal block could be shipped with them opened, but you should check by trying to loosen the screw in each one. If it clicks softly as you loosen the screw, it's fully opened. Make sure they're tight after inserting the wires! Make sure that there's no stray strands escaping the terminal position for either bundle. A single strand could short the power supply and cause you no end of grief.

Grab the last two pair of yellow & black wires and strip about 3/8" of insulation from each one.

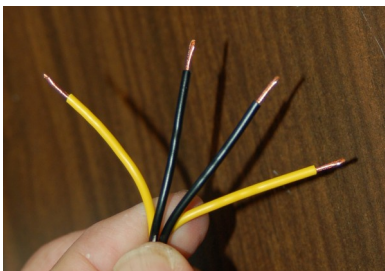

Fig. 3-26: Stripped!

Now insert these last four wires into the compression terminal block connector **EXACTLY AS SHOWN**.

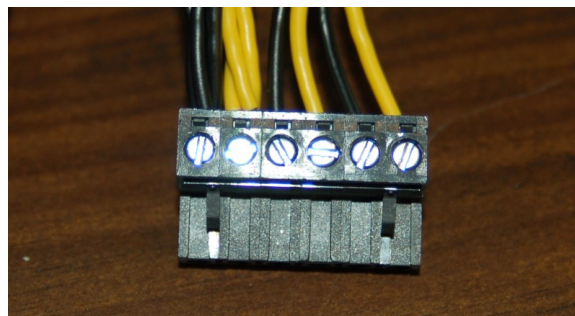

Fig. 3-27: Finished power connector.

Rostock MAX v2 Assembly Guide

The reason I emphasize “**EXACTLY**” for the power connector is that if you connect it backwards, the power supply won't notice, but you'll completely destroy the RAMBo controller.

I'd recommend bundling the four pair and two pair wire bundles together – it will help act as a strain relief for the four pair going into the compression terminal block, and it looks pretty neat too. :)

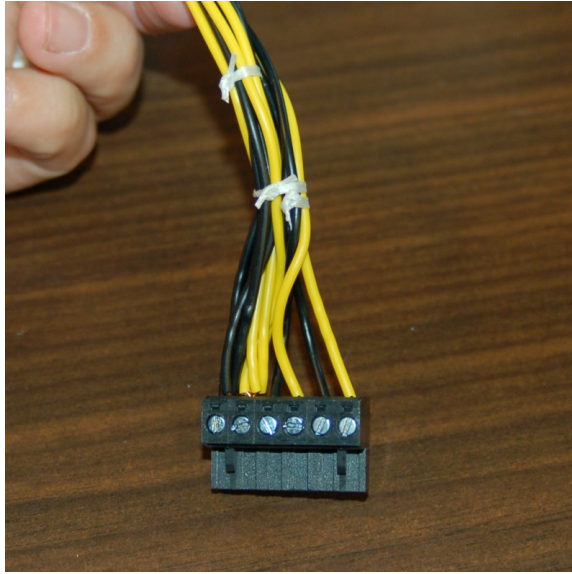

Fig. 3-29: Bundled up!

The final task in this chapter is add the spade lug connectors to the power-on wiring.

Strip off about 3/8” of insulation from the black & green wires that you cut from the big ATX connector and crimp the spade lug connector to each as shown in Fig. 3-30.

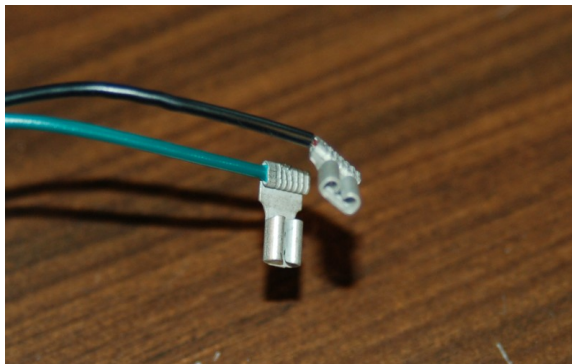

Fig. 3-30: Spade lugs attached.

Rostock MAX v2 Assembly Guide

Set the power supply aside and we'll begin the main construction process!

4 – Building the Base

For the following task, you'll need the following parts:

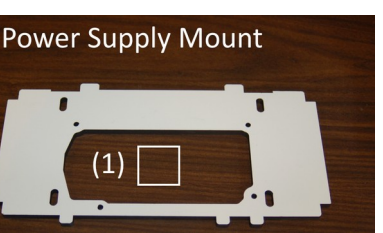
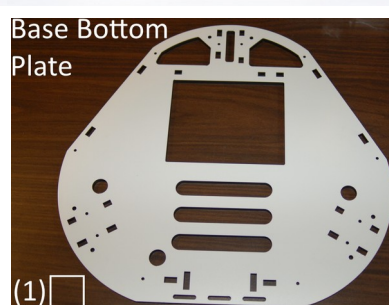
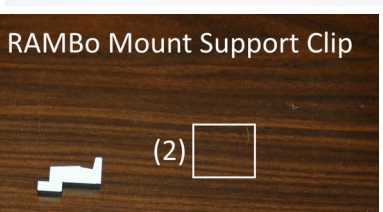
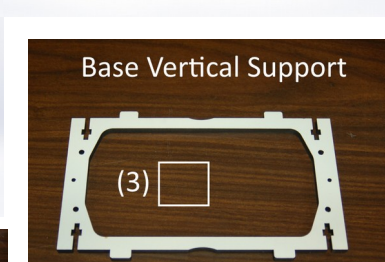
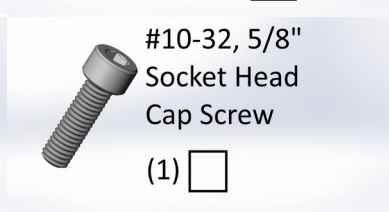
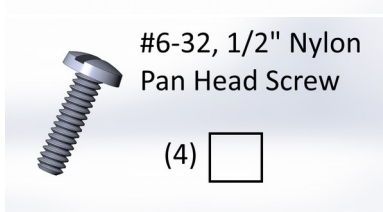
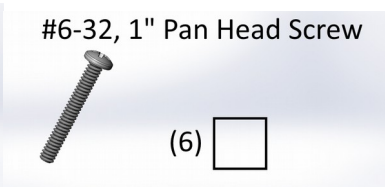
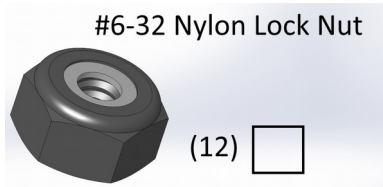

Installing The Feet

The feet on the Rostock MAX v2 are made from a hard plastic “foot” that is held in place by a nylon screw & bolt and is covered with a soft rubber “shoe”.

The feet are installed on the bottom of the Base Bottom Plate. The design of the Base Bottom Plate causes it to have asymmetric features – this means that if you were to bisect the plate down the center, the left & right “halves” wouldn't be a mirror of one another. This means that we've got to make sure that we install the feet on the right side of the plate. If we don't, they'll be facing “up” and won't be much good for holding the machine off the table. :)

The top surface is easily identified. Lay the Base Bottom Plate flat with the large square opening facing you. When the plate has the right “face” up, the two notches below the rectangle will be on the left and the single notch will be on the right. See below for the correct orientation. I'd advise that you write “Top Face” on yours as I've done here.

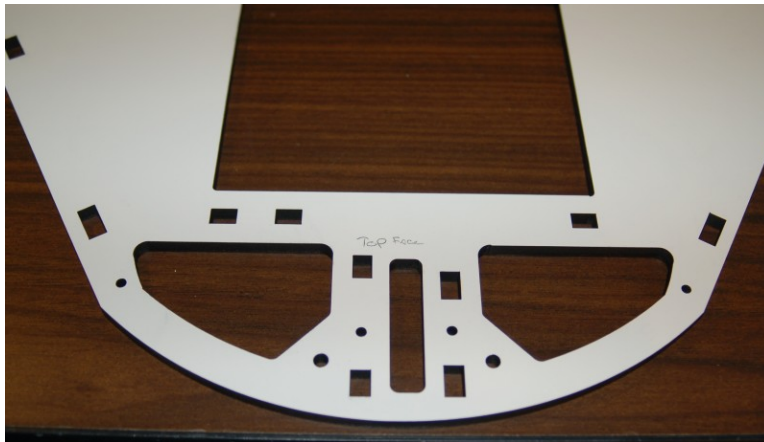

Fig. 4-1: Getting the base plate face up.

Grab one of the black foot bases and a nylon screw and drop the screw into the foot as shown.



Fig. 4-2: Screw orientation.

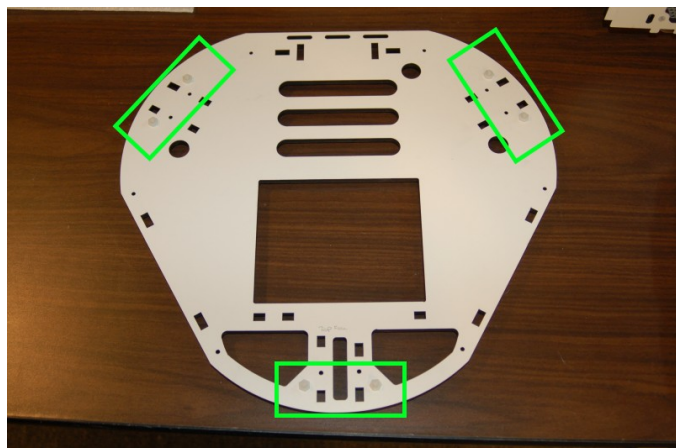

Fig. 4-3: Foot locations.

Install two feet at each location indicated by the green rectangles in Fig. 4.3 on the previous page.

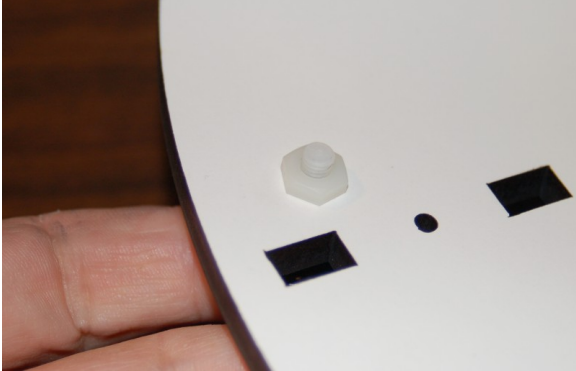

Fig. 4-4: Nut on foot screw.

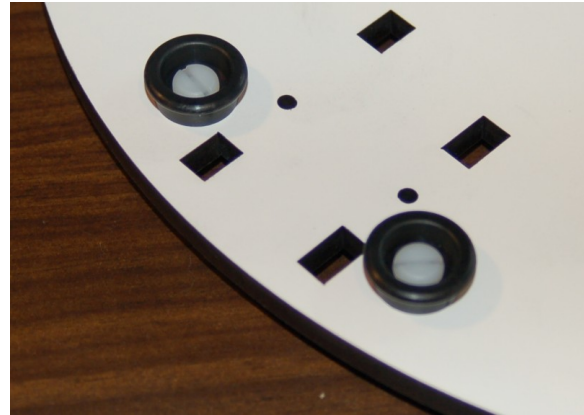

Fig. 4-5: Two feet installed.

Preparing the Vertical Supports

The vertical supports need to have four #6-32 Nylon lock nuts and two #6-32, 1/2" Stainless Steel flat head screws installed in each one. The side panel retaining holes will also need to be threaded.

The 1/2" screws are used to retain the Acrylic side panels that we'll be installing toward the end of the build. Let's get those installed first.



Fig. 4-6: Retaining screw installed.

Each of the three vertical supports should have one 1/2" flat head screw installed in each end as shown on the left. You don't want to install the screw all the way – just drive it enough so that the bottom face of the screw is flush with the opposite face of the vertical support as shown below.

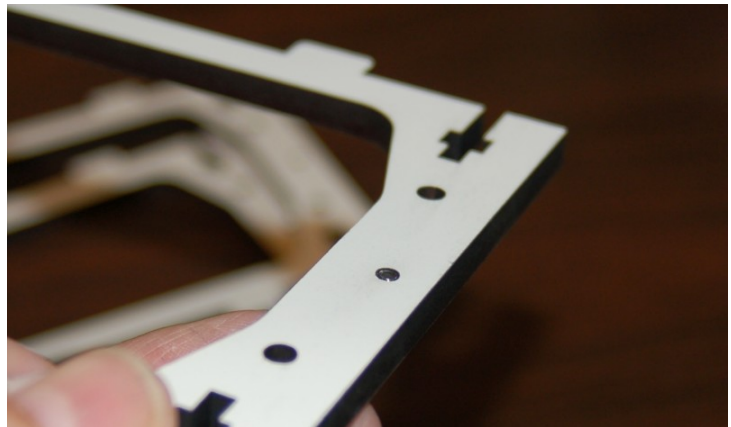

Fig. 4-7: Correct screw depth.



Fig. 4-8: Vertical support with retaining screws.

Now I need you to locate the #10-32, 5/8" Socket Head Cap Screw. We're going to use this to cut threads into the vertical support plates. These threaded holes will be used later with nylon thumbscrews to hold cover plates in place. You'll need a 5/32" Allen wrench to drive the screw in.



Fig. 4-9: Redneck Tapping Tool.

There are two holes on each end of the vertical supports that can take the retaining screws we're cutting threads for. The holes you need to use are the "top" ones.

Write "top" on each vertical support plate in the location shown in the figure below and then carefully drive the #10-32 socket head cap screw through the hole closest to the "top". Drive the screw through completely and then remove it. Repeat this for the other two vertical support plates.

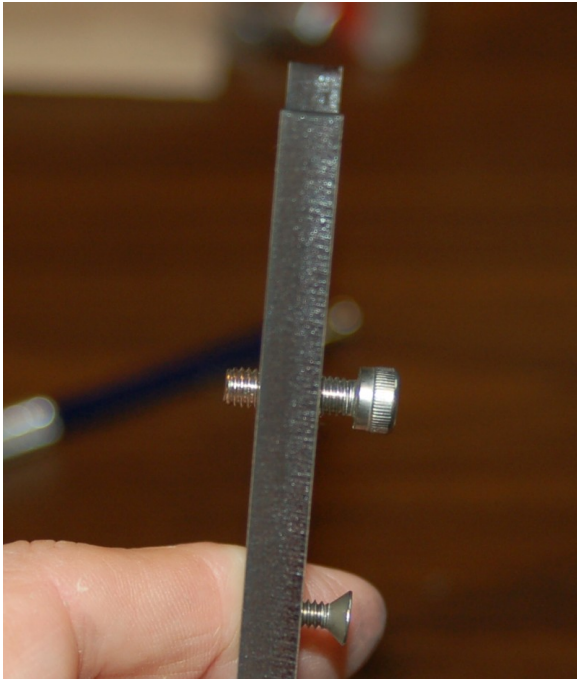

Fig. 4-11: Drive the screw all the way through.

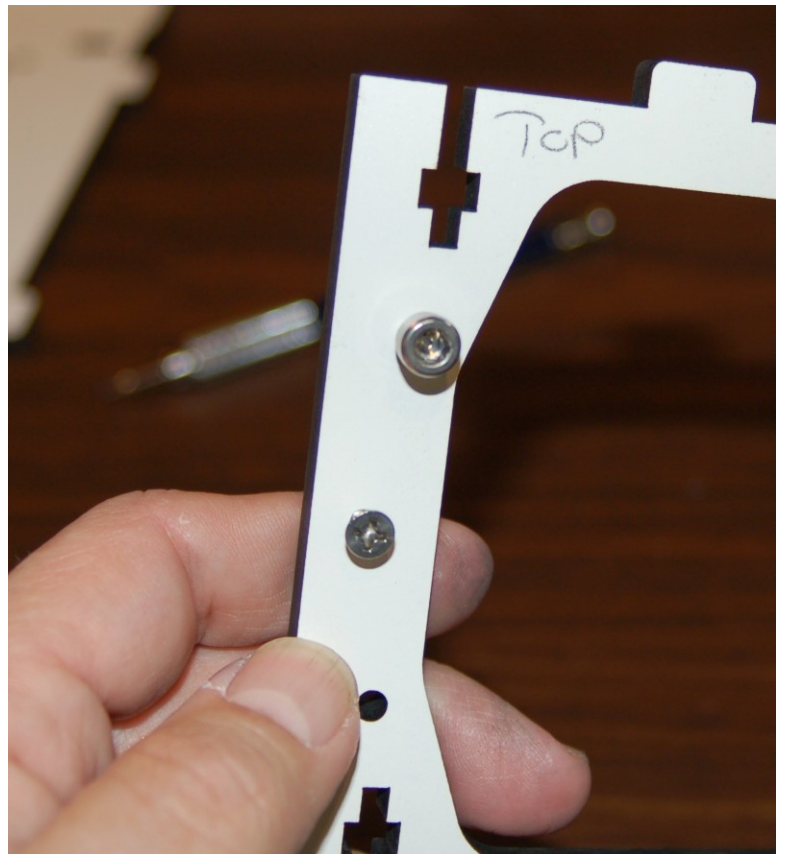
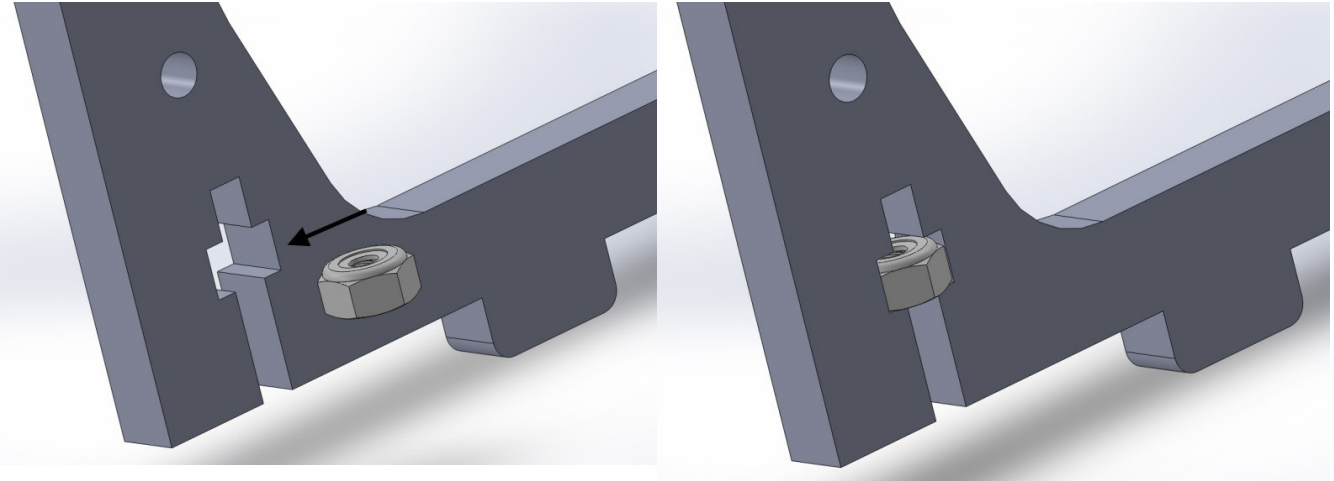

Fig. 4-10: Marking the top of the part.

Rostock MAX v2 Assembly Guide

The primary method of assembling the Rostock MAX v2 relies on capturing #6-32 nylon lock nuts in laser cut pockets. When a screw is threaded through a part and into that captured nut, it creates a very simple, strong joint. The nuts are installed in the laser cut pockets as shown below. Note how the bottom face of the nut is facing the outer edge of the part.



As you can see, the nut is oriented such that the flat sides of the nut fit into the laser cut pocket. The laser cut pockets are designed to be a very snug fit. However, sometimes the pockets may feel a bit too tight. If this is the case, try inserting the nut in from the other face. It may be easier due to the slight bevel the cut has in it due to the laser focus. You may also run into a situation where the nut pocket doesn't hold the nut tightly enough to keep it from falling out. In that case, you should use a small bit of tape to hold the nut in place until there's a screw driven into it.

The simplest way to install the lock nuts is to use a pair of needle nosed pliers and grip the nut as shown in Fig. 4-12.

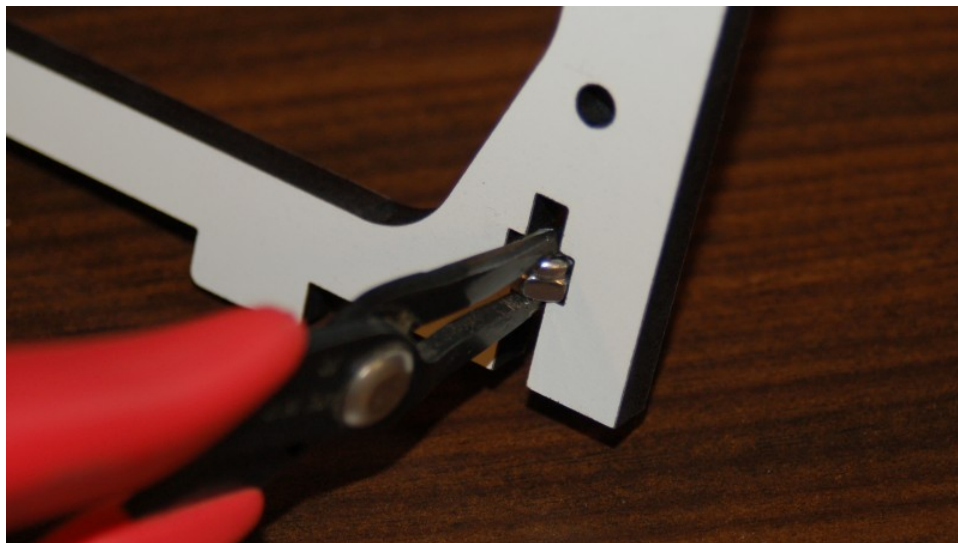

Fig. 4-12: Setting a nut in the laser cut pocket.

Rostock MAX v2 Assembly Guide

When you're done with one of the vertical supports, you should have four nuts installed as shown:

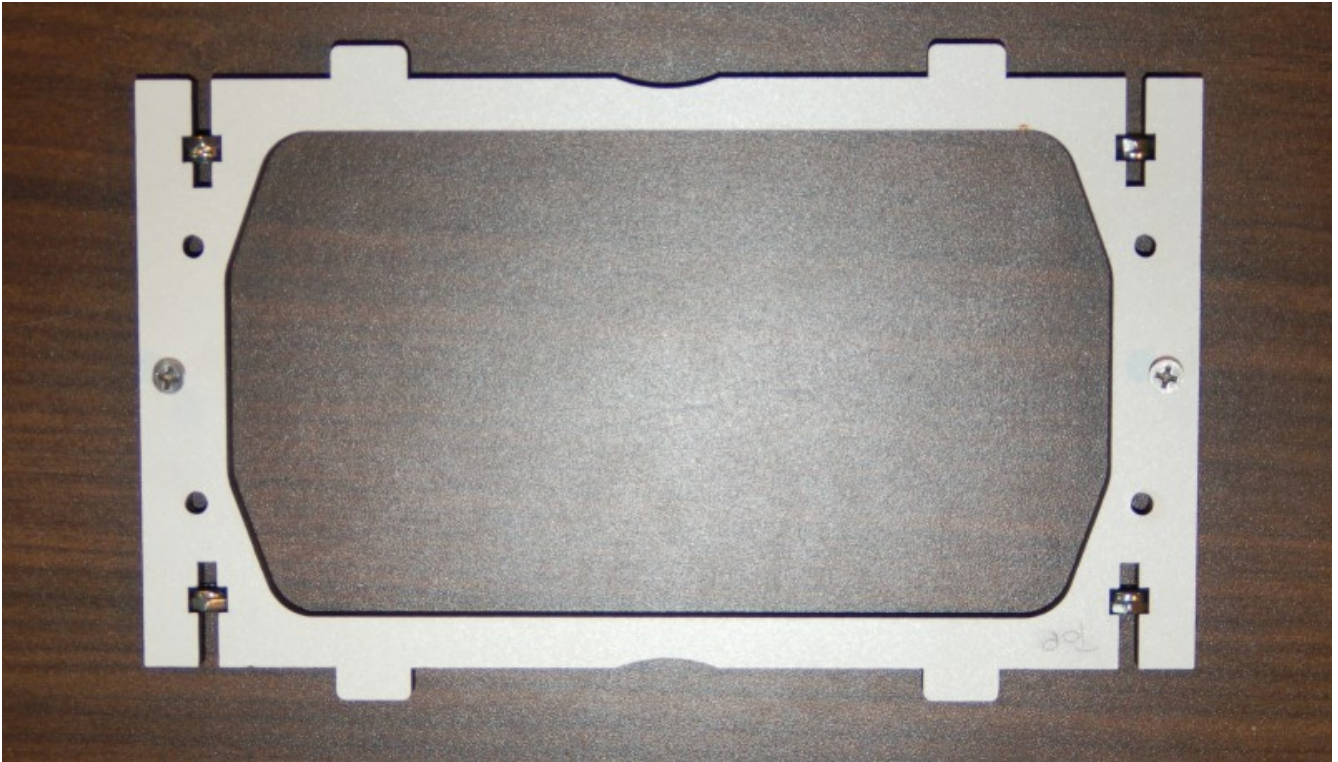

Fig. 4-13: All four nuts installed.

Go ahead and install the eight remaining nuts in the two vertical supports.



Fig. 4-14: All done.

Installing the Vertical Supports and Power Supply

Before the two back vertical supports can be installed, we need to install the power supply on the power supply mounting plate with the four #6-32, 1/2" Nylon pan head screws.

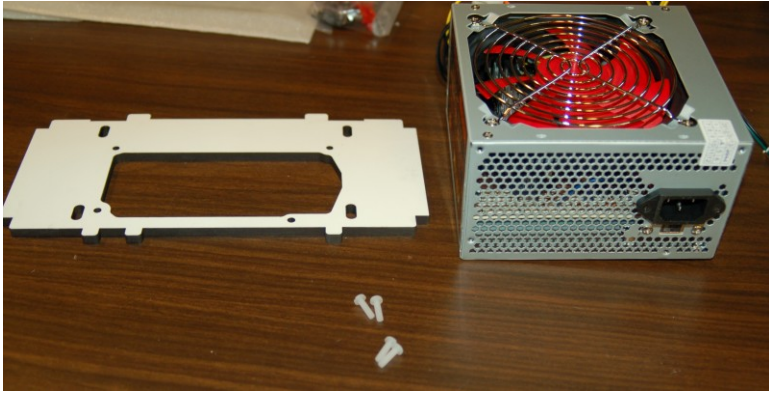

Fig. 4-15: Power supply, mount & hardware.

The power supply mount is designed such that it only fits one way (shown above) and it's a pretty easy install. The method I've found that works the easiest is to pin the power supply between my knees while I install the mount.



Fig. 4-16: Ready for the nylon screws.

To attach the power supply mount, all you need to do is thread the nylon screws in with your fingers and then lightly tighten with a flat bladed screwdriver. Take care to not over-tighten the screws!



Fig. 4-17: Installing the nylon screws.

Rostock MAX v2 Assembly Guide

The power supply base is held in place with the vertical supports that are installed to either side of it. You'll install all three parts at the same time – the fit tolerance is loose enough that they just drop in. **Make sure that when you're installing the vertical supports that the 1/2" screws you installed are facing inward.** These screws are used to capture the acrylic covers that are installed later.



Fig. 4-18: Vertical support & power supply installation.

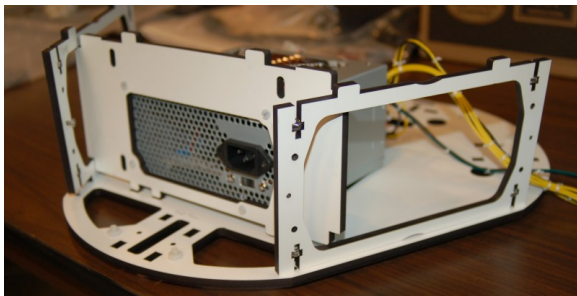

Fig. 4-19: Right side view of the installation.

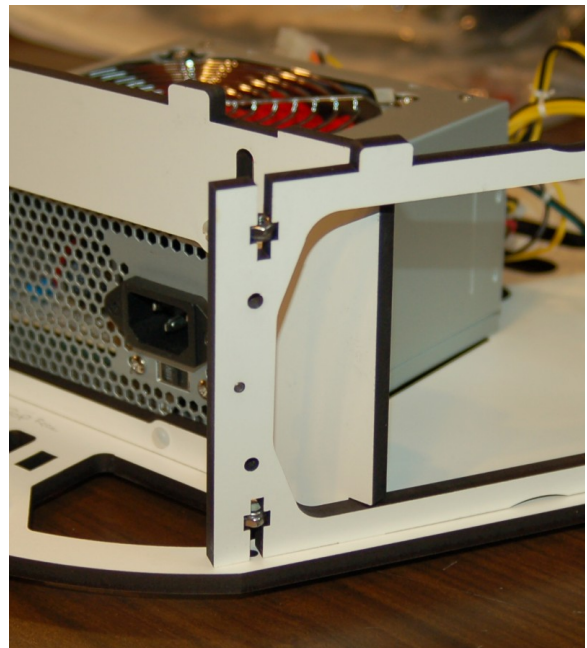

Fig. 4-20: Right side fully seated.



Fig. 4-21: Both sides seated.

Now install a #6-32, 1" long pan head screw into each of the four lower nuts. This attaches the vertical supports to the bottom. Leave them just a little bit loose for now. Leaving them a bit loose will make installing the top a lot easier when we reach that point.

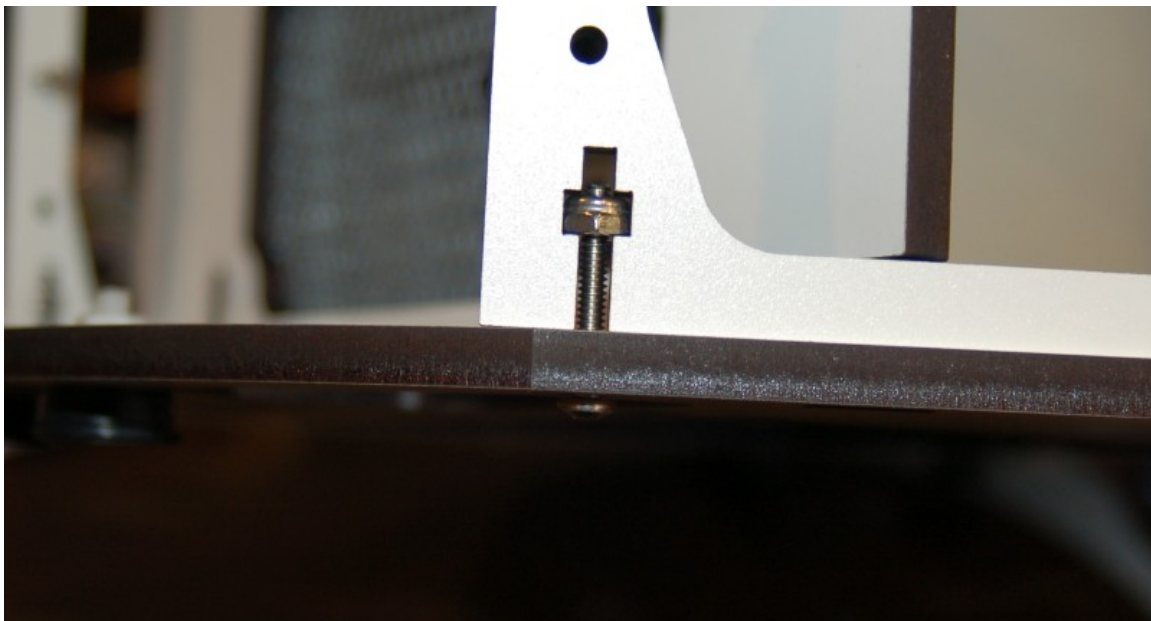

Fig. 4-22: Example of an installed screw.

Before you can install the last of the three vertical supports, you'll need to install the two

Rostock MAX v2 Assembly Guide

RAMBo support panel legs to the front of the base.

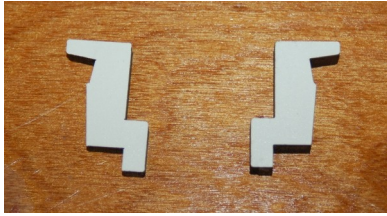

Fig. 4-23: Support Legs.

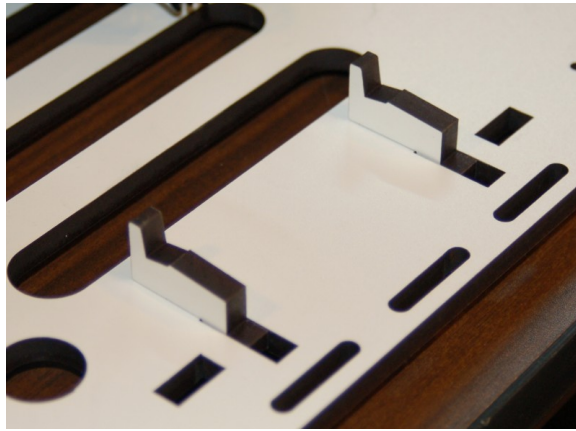

Fig. 4-24: Support legs installed.

The support legs just rest in place – they're held firmly when the support plate is installed over the top of them.

Use two #6-32, 1" Stainless Steel pan head screws to attach the front vertical support over the two RAMBo legs as shown below. Like the two back supports, leave this a bit loose in order to assist with fitting the top.

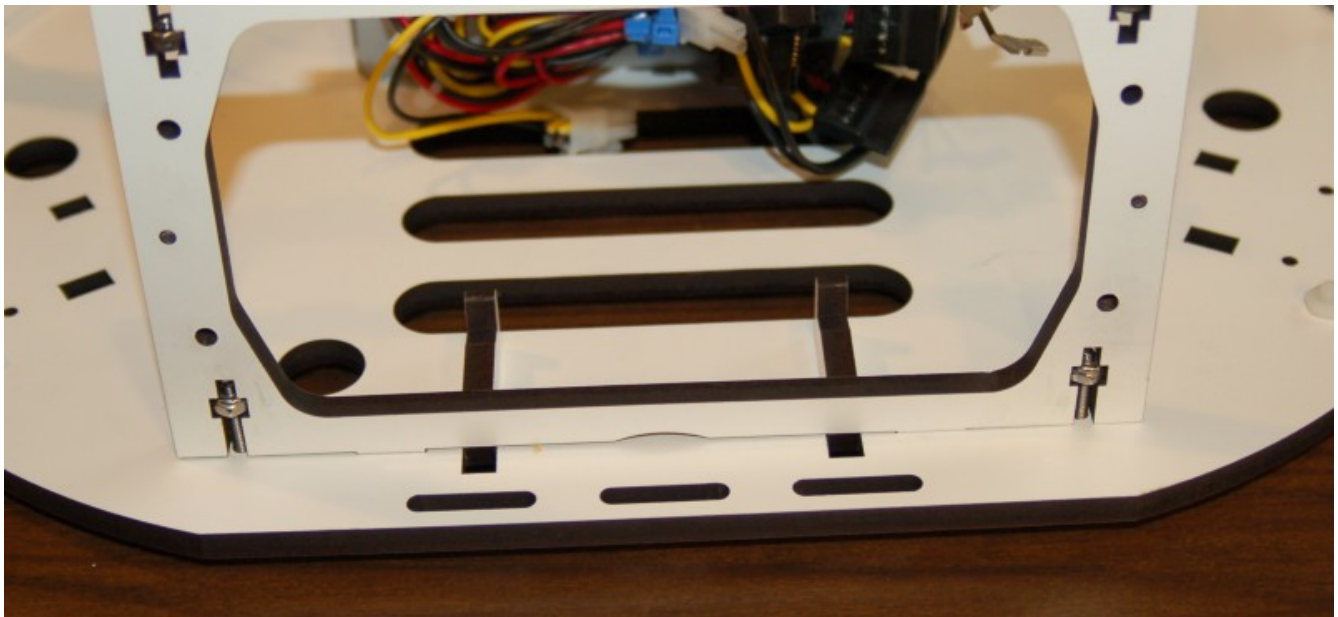

Fig. 4-25: Front vertical support installed.

Checkpoint Video #1: <http://youtu.be/Bdv5sja3EQk>

Installing the Drive Gears on the Stepper Motors

For this task, you'll need the following components:



Three Stepper Motors



Drive Gears



Thread locker

The stepper motors that are shipped with your Rostock MAX v2 kit are equipped with a “flatted” shaft. This means that a portion of the drive shaft has been ground flat. This ensures that a properly tightened drive gear won't be able to rotate on the shaft when properly tightened.

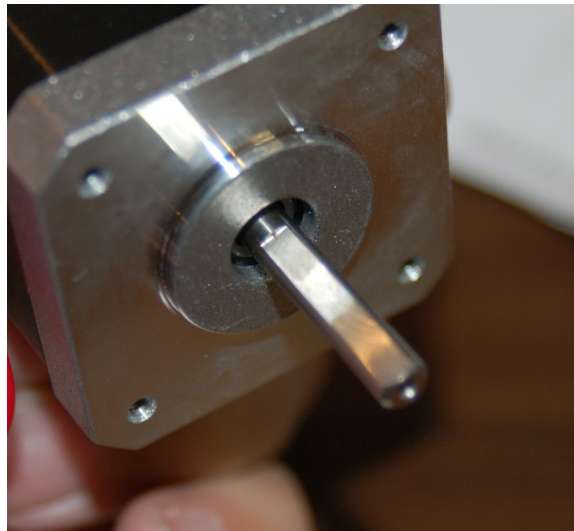

Fig. 4-26: Flatted shaft.

Thread one of the grub screws into a pulley and slide the pulley on to the stepper shaft as shown. Make sure that the grub screw is aligned with the flatted portion of the shaft. You *also* want to make sure that the tip of the stepper shaft is flush with the outside face of the pulley – again, as shown below.

Rostock MAX v2 Assembly Guide



Fig. 4-27: Pulley & grub screw aligned.

Now get your thread locking compound and dribble a little bit on to the threads. I kind of overdid it, but it'll work just fine.

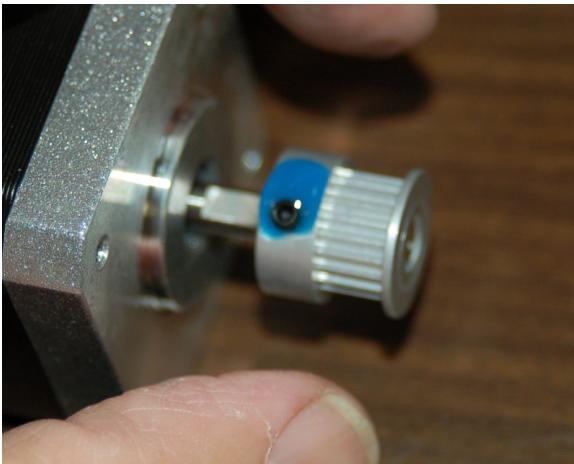

Fig. 4-28: MOAR THRED COMPOUND!

You'll want to use the included Allen wrench to tighten down the grub screw. Wipe off any excess thread locking compound after the screw is tightened down.

Install the second grub screw using the same process you followed for the first.

Rostock MAX v2 Assembly Guide

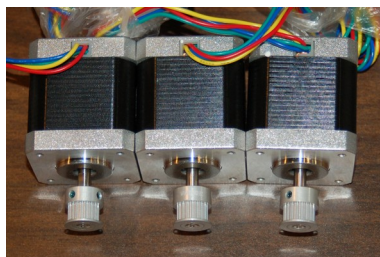
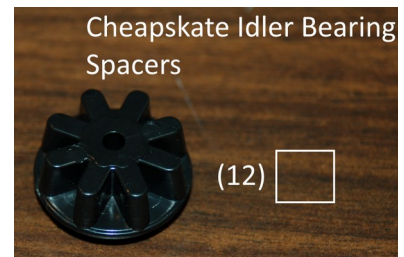
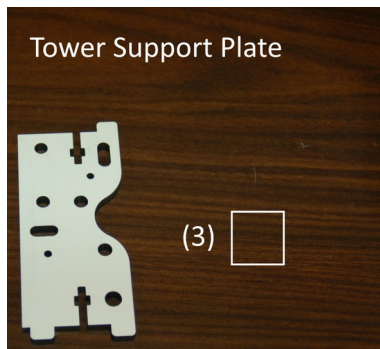
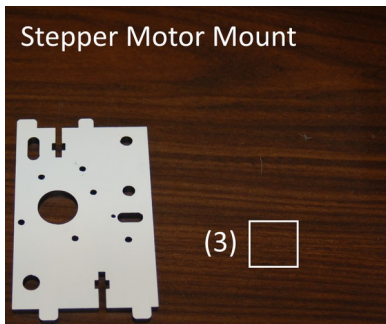

Fig. 4-29: Properly installed pulley.

Now install the drive pulleys on the other two stepper motors the same you did with this one.

Assembling the Tower Supports

For this task, you'll need the following components:



3 Stepper with Drive Gears

Rostock MAX v2 Assembly Guide

First up, you'll need to put together the six belt support bearings by sandwiching each 608ZZ bearing between a pair of the black idler bearing spacers.



Fig. 4-30: Idler bearing components.

The idlers are very simple to assemble...



Fig. 4-31: First one side...



Fig. 4-32: ...and then the other!

Go ahead and assemble the other five bearings and set them aside.

Rostock MAX v2 Assembly Guide

Before we can assemble the tower supports, you'll need to do a little prep work on the Stepper Motor Mounts. Each mount will get two #6-32 nuts and one #4, 3/8" pan head machine screw.

Lay out the mounts exactly as shown in the figure below.

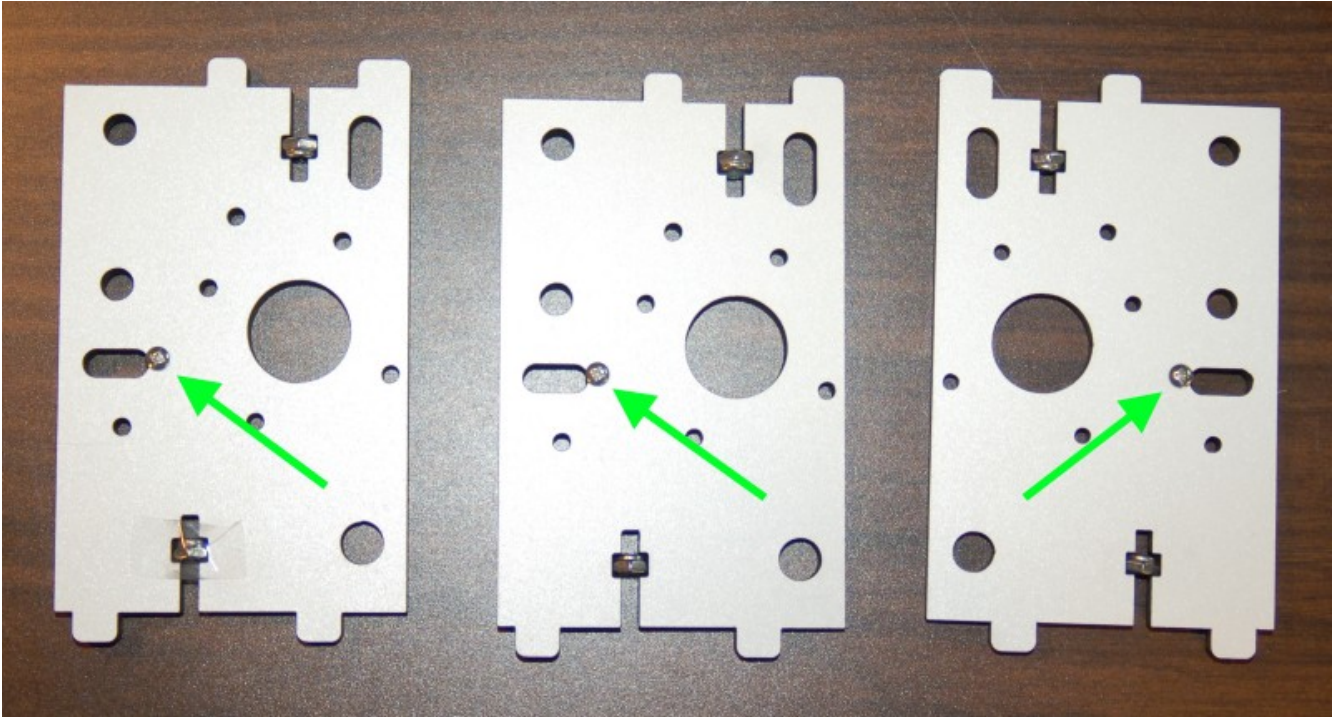

Fig. 4-33: Prepping the stepper motor mounts.

The green arrows show the position where you'll install each #4, 3/8" pan head screw. These screws are used as an alignment stop. When it comes time to set the towers in place, you'll slide the tower down until the bottom strikes the head of the screw. This will guarantee that you've got all three towers at the same height.

You may notice there's a bit of Scotch tape on the left-most mount. This was done because the laser cut pocket was just a bit loose and I needed to be able to hold the nut in place until there was a screw in it.

Note that the two mounts on the right are mirrors of one another. This was done on purpose. The X and Y axis mounts are facing one another and if you don't mirror one of the mounts, you'll have two that fit fine and one that won't fit at all. :)

Rostock MAX v2 Assembly Guide

Now it's time to get the stepper motors attached to their mounts. Set the Stepper Motor Mount on top of a stepper motor and align the stepper motor as shown in Fig. 4-34 and install it using four of the M3x10mm screws. Apply a little bit of thread locker to each one before installing.

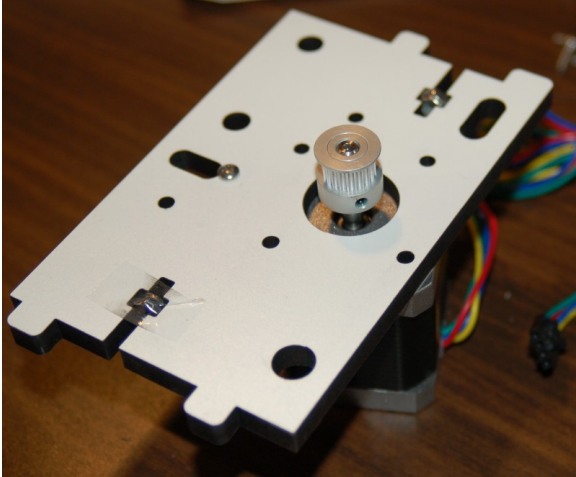

Fig. 4-34: Mounting plate alignment.

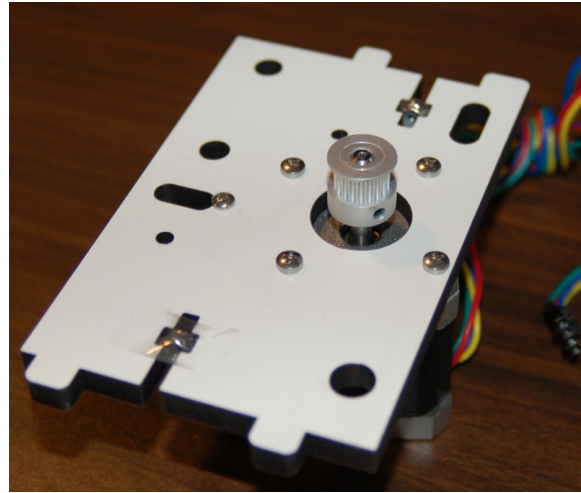

Fig. 4-35: Screws installed.

Assemble the next stepper motor mount the same as you did the first one, but assemble the third one mirrored. When you're done, the three mounts should look like the figure below.

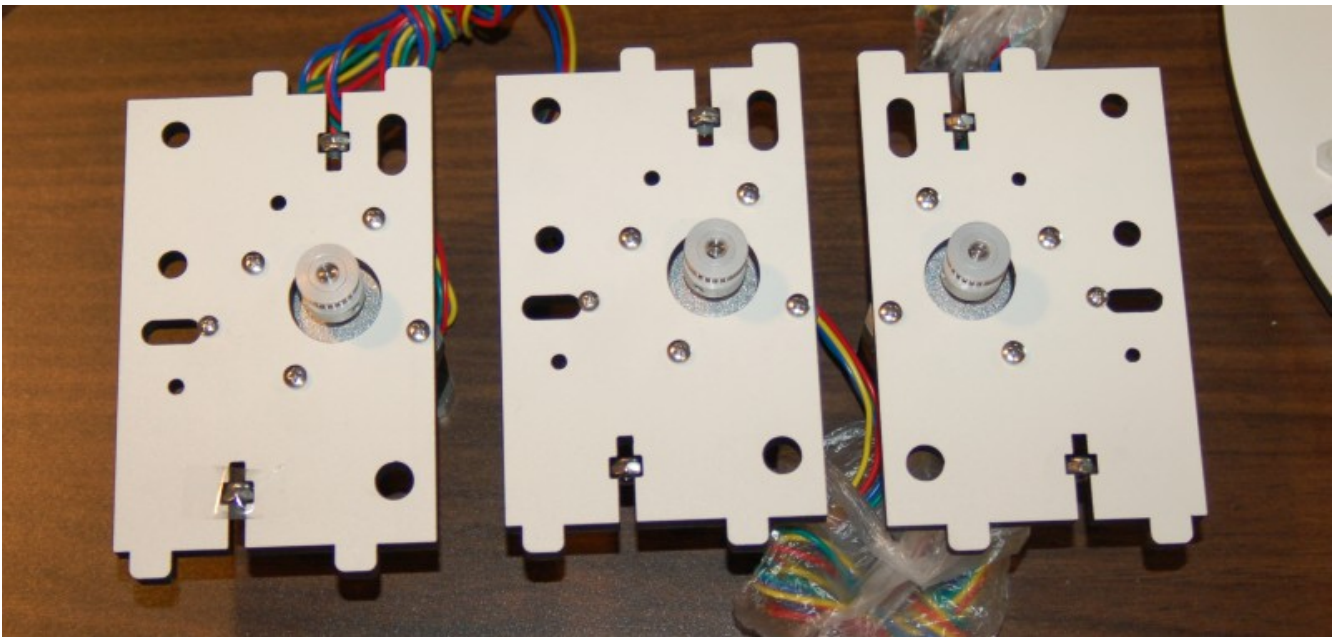

Fig. 3-36: Correct assembled stepper motor mounts.

Rostock MAX v2 Assembly Guide

Now install two #6-32 nylon lock nuts into the three tower supports as shown below.

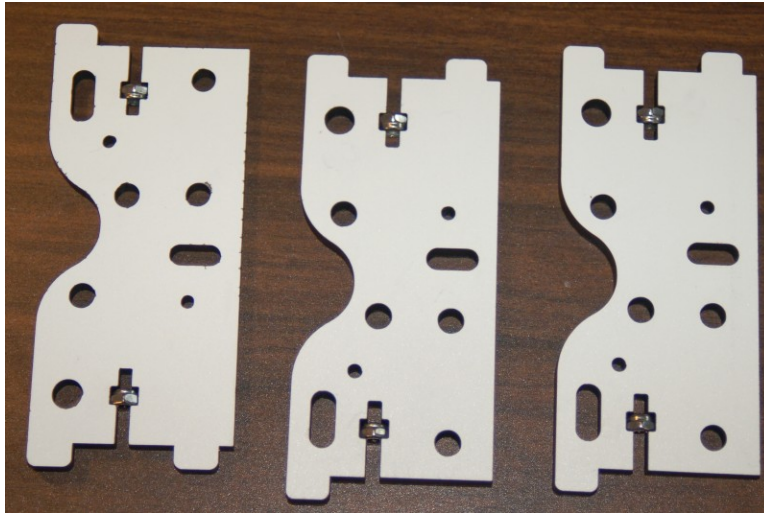

Fig. 4-37: Tower supports ready to go.

Each tower support holds the idler bearing assemblies that you put together. In order to install them, you'll need to add a #6-32 washer to two of the #6-32, 1-3/4" Stainless Steel flat head screws and insert them into the back of each stepper motor mounting plate as shown below:

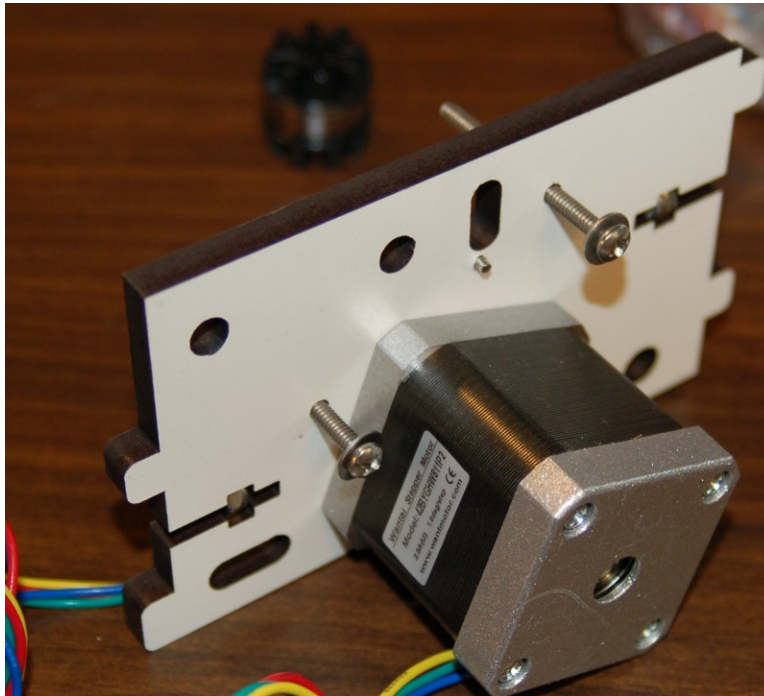

Fig. 4-38: Idler bearing support screws.

Rostock MAX v2 Assembly Guide

Install two of the idler bearing assemblies on the two screws you just inserted and add the tower support plate on top. Add two #6-32 flat washers and two #6-32 Nylon lock nuts and tighten them finger tight. The looseness will help install it in the bottom plate and assist in fitting the top plate.

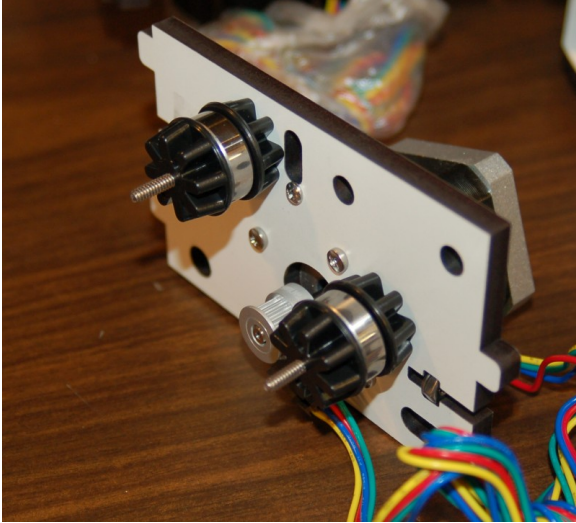

Fig. 4-39: Idler bearings installed.



Fig. 4-40: Tower support installed.

Repeat this process for the other two assemblies.

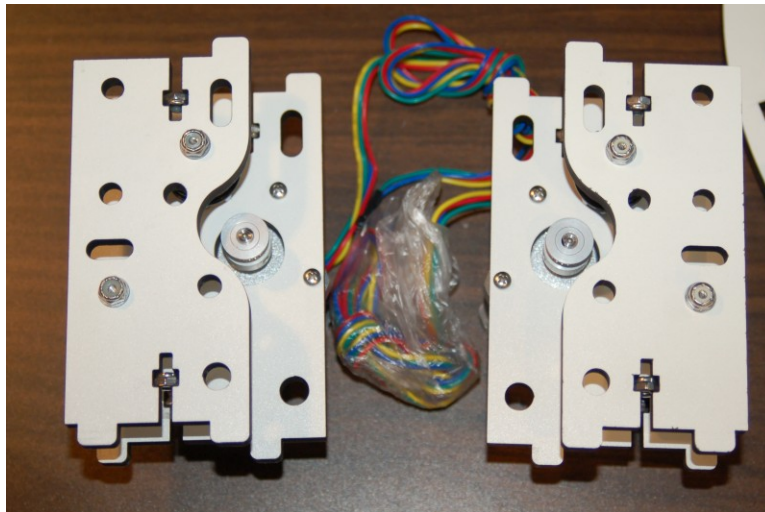

Fig. 4-41: X and Y axis motors.

Checkpoint Video #2: <http://youtu.be/vckZcN8XmQc>

Rostock MAX v2 Assembly Guide

Now let's get the three tower support & motor assemblies attached to the base of the machine.

Drop the X and Y axes in as shown below. Install two #6-32, 1" pan head screws into each one, just a bit more than finger tight. We want a bit of wobble to help with the installation of the top.

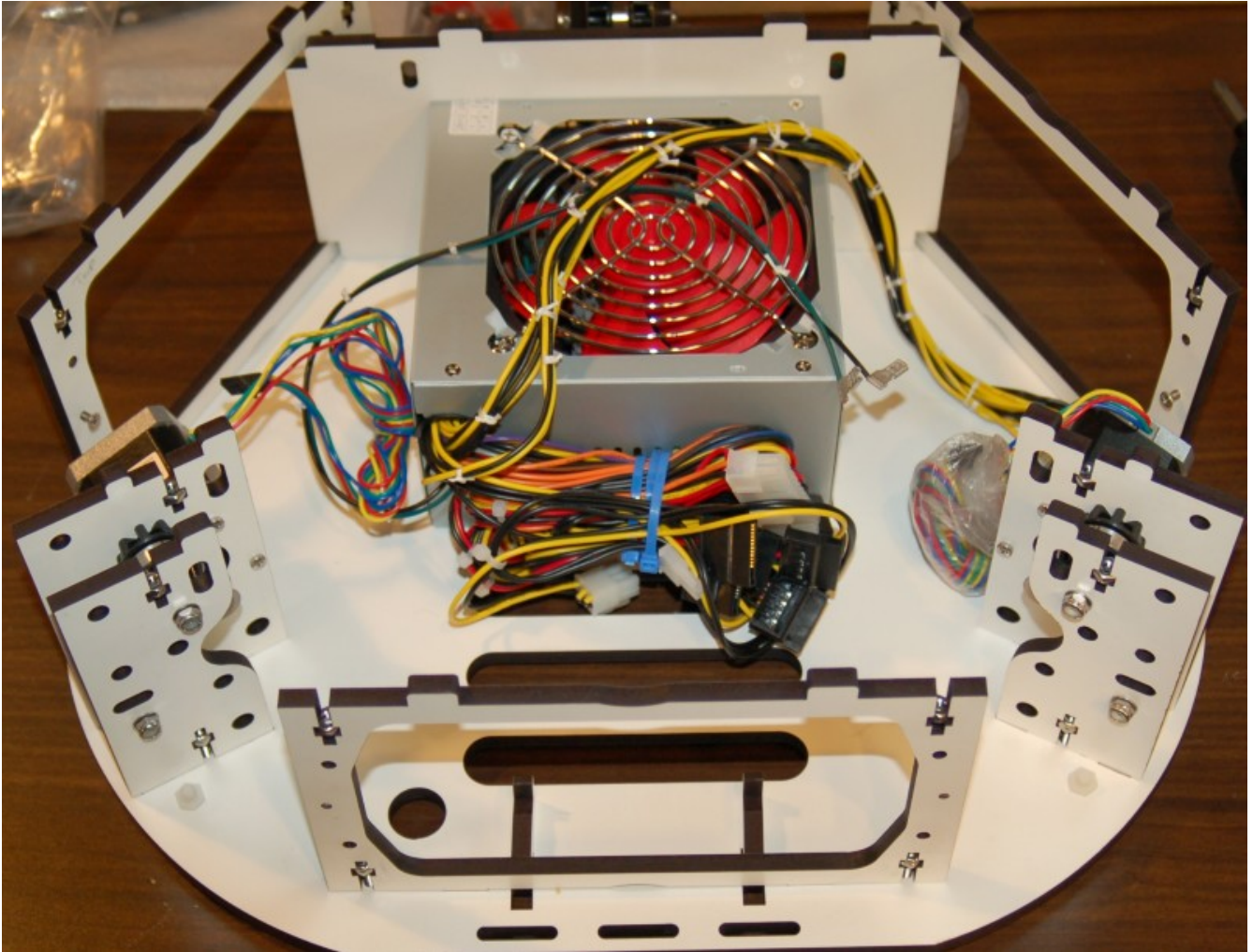

Fig. 4-42: X and Y axis tower & motor supports in place.

Rostock MAX v2 Assembly Guide

The Z axis (in the back of the machine) tower & motor support installs the same way as the other two. The wires for the Z axis stepper motor should be routed through the lower hole in the power supply bracket as shown below. The connector is a tight squeeze, but it WILL fit.

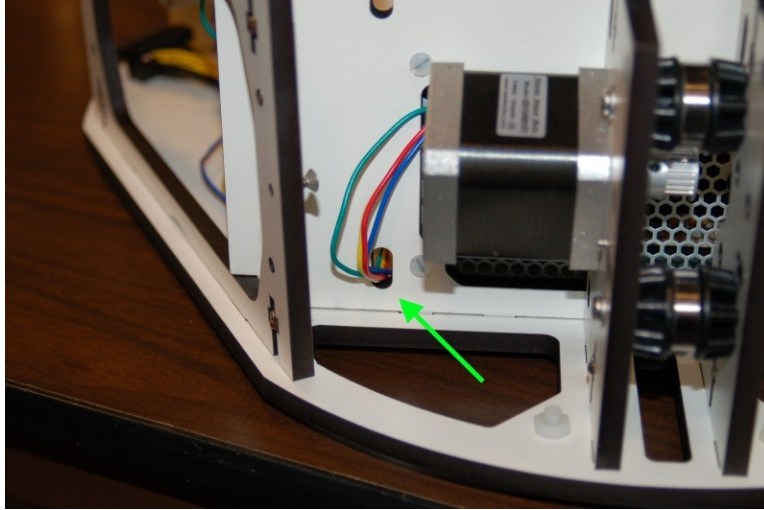

Fig. 4-43: Routing the Z axis stepper wires.

Now you need to install four of the ¼-20 cap head screws and four T-Slot nut plates into each tower support assembly. Only thread the T-Slot nut plates enough to feel the end of the screw catch all the threads in the plate – the space is needed in order to properly fit inside the slot in the tower.

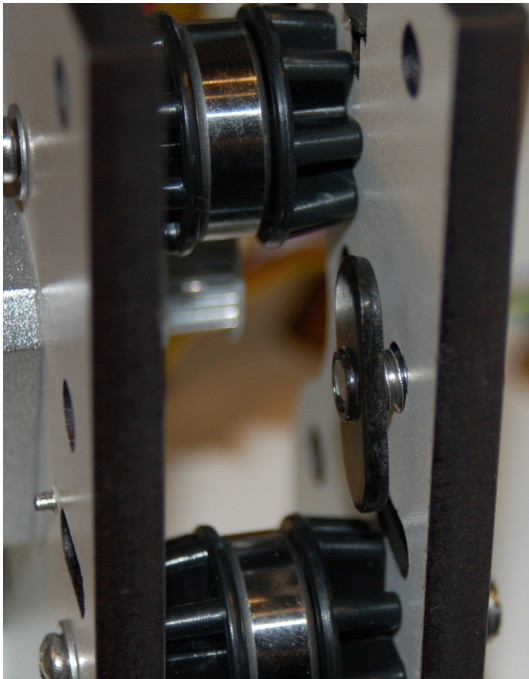

Fig. 4-44: T-Slot nut plate installed.

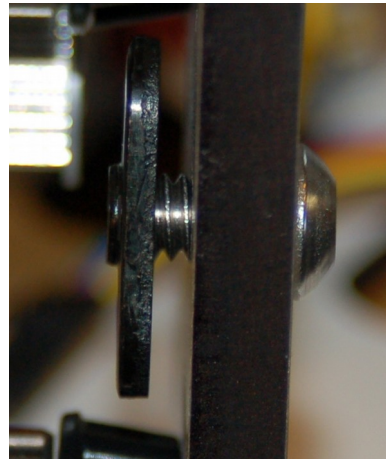

Fig. 4-45: Depth example.

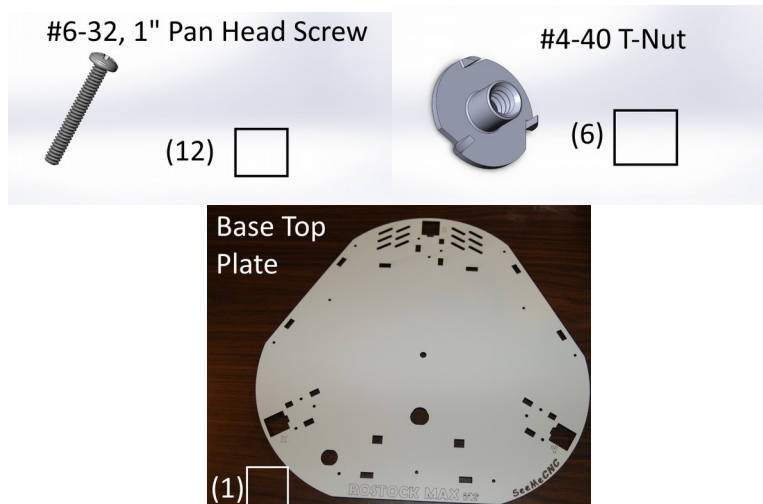

Fig. 4-46: All four in place.

Checkpoint Video #3: <http://youtu.be/HgluRmxKL5Y>

Installing the Base Top Plate

The next task requires the following components:



The six t-nuts specified above should come from the Onyx Heated Bed package and not from the t-nuts included in the hardware pack.

Rostock MAX v2 Assembly Guide

The next step requires that you open up the Onyx Heated Bed package and remove the included #4-40 T-Nuts.

Using Fig. 4-48 below as a guide, flip the top plate upside down and tap in the six t-nuts in the locations circled in green. The t-nuts have barbs that will penetrate into the Melamine when pressed in with enough force. I'd recommend using a hammer – a single sharp tap should be enough to set the t-nut flush with the Melamine surface. After the t-nut is in place, cover it with a short length of Scotch or masking tape to hold it in place. You don't want them to pop out on you when you're installing the Onyx.



Fig. 4-47: Onyx Heated Bed hardware pack.



Fig. 4-49: Base plate top & base orientation.



Fig. 4-48: T-Nut locations under the top plate.

Rostock MAX v2 Assembly Guide

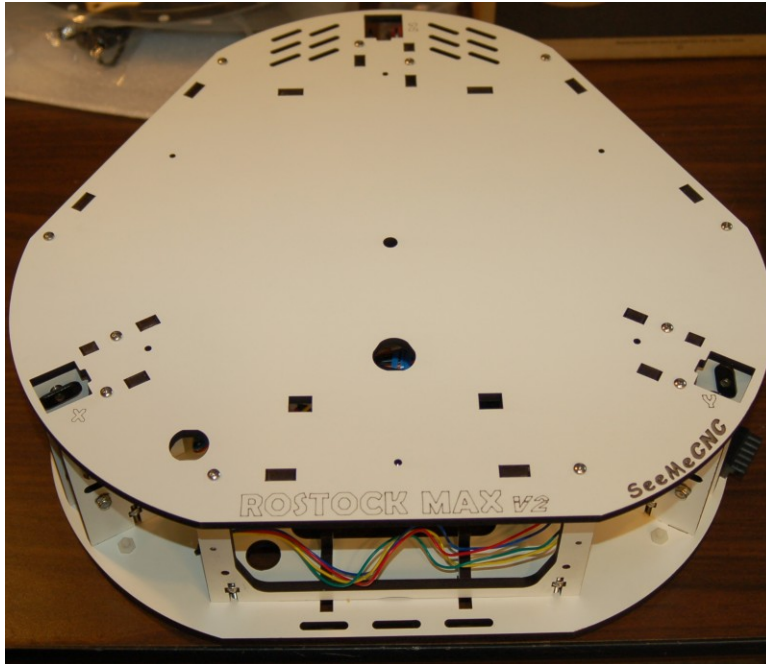

Fig. 4-50: Base top installed!

In order to install the top plate on the base you've assembled, you'll need to carefully begin to align the tabs in the three vertical supports and the three tower supports with the notches in the top plate. As you work one section down on to the tabs, install a #6-32 1" screw at a near hole to keep that section from popping out while you're working your way around the top. It takes a little patience to get done, but it's *vastly* easier than installing the original Rostock MAX top plate.

Once you've gotten the top fully seated, fully tighten all of the #6-32 1" screws. Tighten the three vertical supports both top and bottom and then tighten down the three tower supports. Also tighten the screws holding the two idler bearings in each tower base.

You don't want to over-tighten them however. If you do, you'll collapse the laser cut nut pockets.

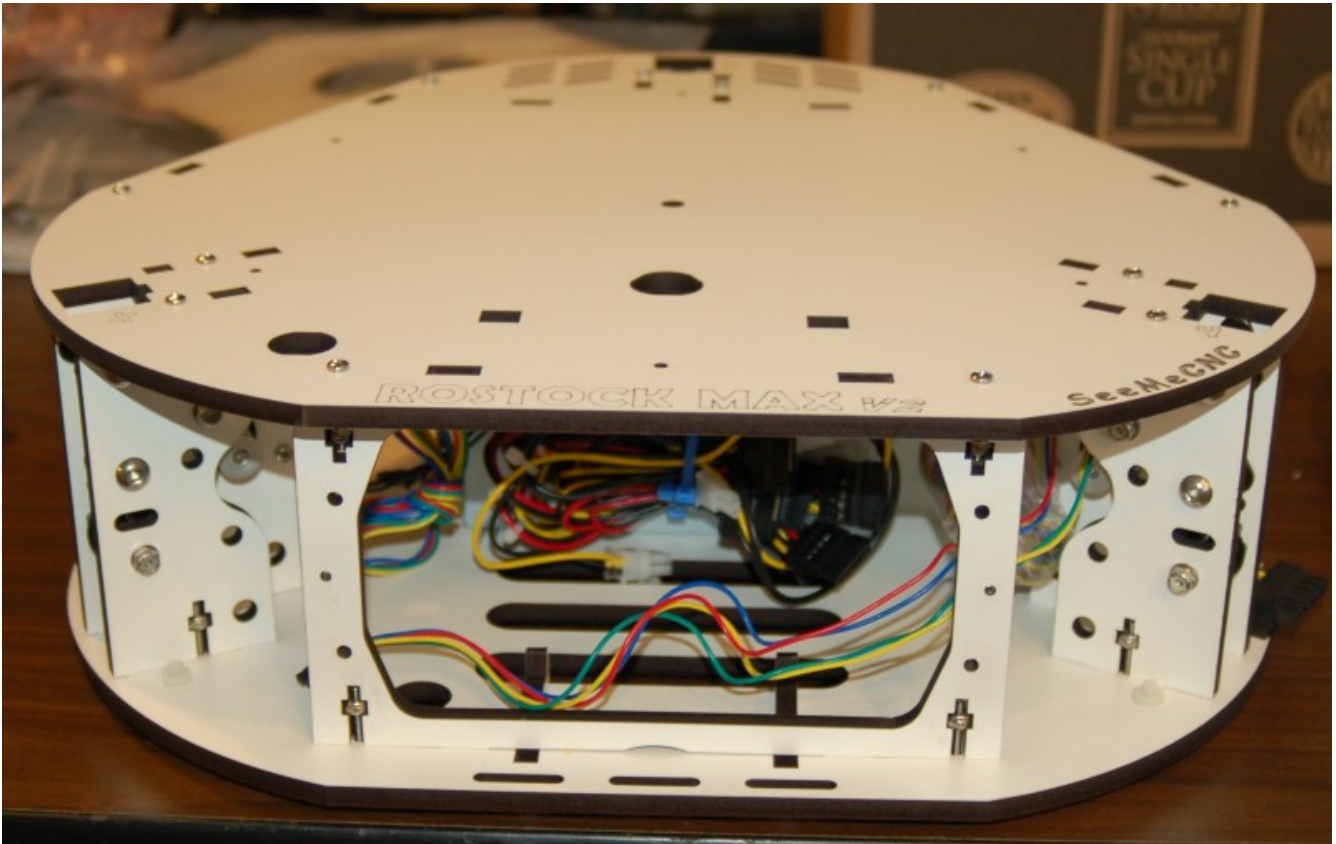

Fig. 4-51: Completed Rostock MAX v2 Base.

Checkpoint Video #4: <http://youtu.be/j2ee-qap4Kw>

5 – Installing the Onyx Heated Bed

Installing the Thermistor, Power LED and Power Wires

For this task you'll need the following components from the Onyx Heated Bed package:

Rostock MAX v2 Assembly Guide

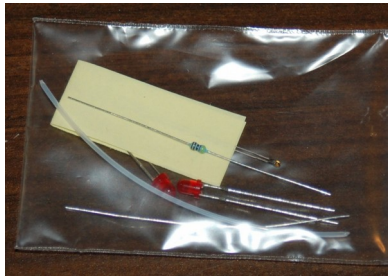

Thermistor & LED Pack



Note that the thermistor pack may contain two resistors and two LEDs. You'll only be using one of each for this build. The additional parts are extras.

Before you begin wiring up the Onyx, please place a short length of Kapton tape over the thermistor hole in the center of the heated bed. This will protect the top of the thermistor as well as prevent RTV from leaking on the top of the board. Leave a little bit of the Kapton folded over. You'll be removing the tape once the RTV has cured.



Fig. 5-1: Covering the center hole.

Once you've got the Kapton applied, open up the small package that contains the thermistor and the PTFE tubing. Cut two 3/8" long bits from the PTFE tubing and slide them on to the thermistor leads. You'll then bend the thermistor the same way you did when prepping the hot end.

Rostock MAX v2 Assembly Guide

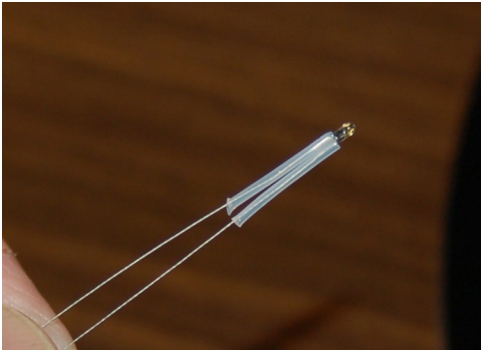

Fig. 5-2: PTFE insulators installed.

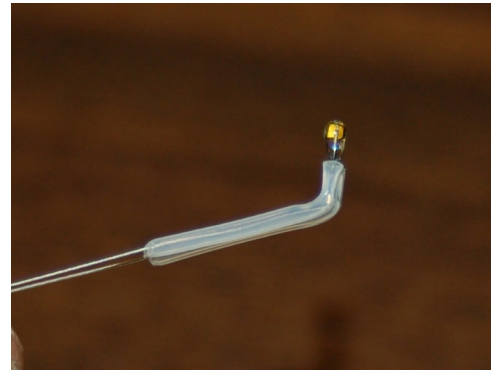

Fig. 5-3: 90 degree bend.

As you did with the hot end thermistor, dip the end of the heated bed thermistor into some RTV and insert it in the offset hole in the Onyx as shown below. Make sure you've got your thermistor oriented as shown.

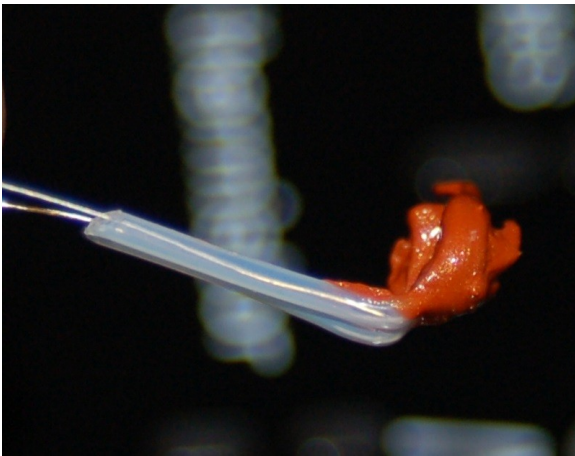

Fig. 5-4: Thermistor head covered in RTV.

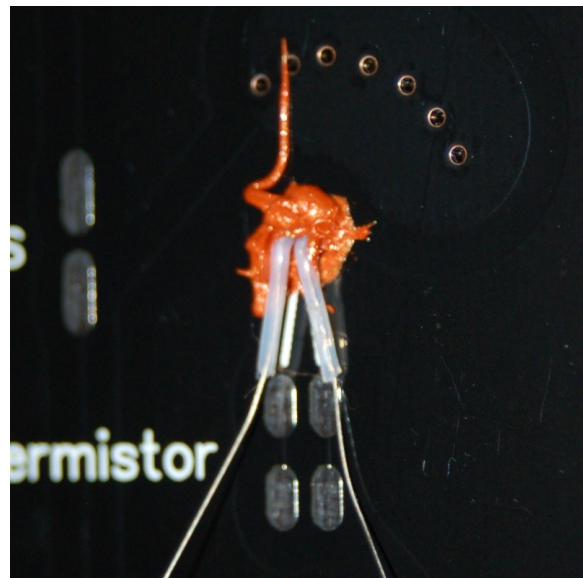

Fig. 5-5: Thermistor installed.

Dip the thermistor end in and out of the hole a few times – this will help to eliminate any bubbles that formed when it was inserted into the hole the first time.

Cover the end of the thermistor with Kapton tape as shown below. This will both protect the thermistor and help you position the leads for the next step – soldering them in!

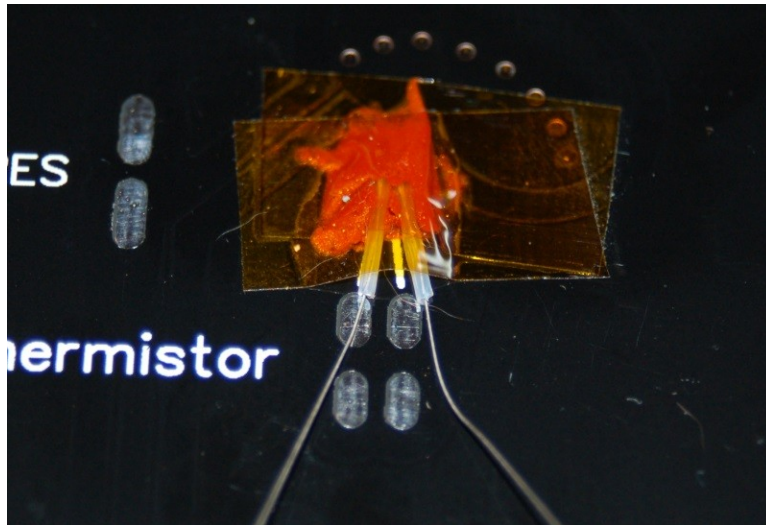

Fig. 5-6: Thermistor taped into place.

Next, solder down the leads to the solder pads. Make sure you don't create a solder bridge between the two pads! Use only enough solder to do the job. When you're done, clip off the excess leads.

Note that we're using the pair of pads closest to the thermistor. The more distant pair is where we'll install the thermistor signal wires.

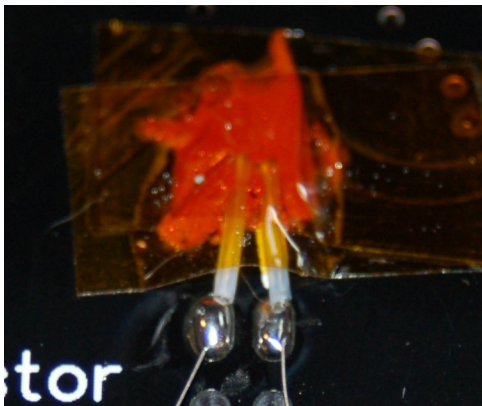

Fig. 5-7: Soldered down..

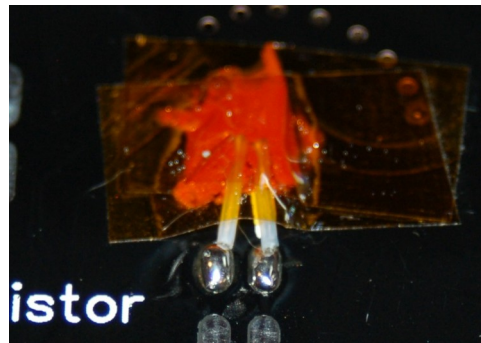

Fig. 5-8: ...and trimmed.

We're going to install the power LED next. The LED has polarity to it, so we need to make sure that it's installed correctly, otherwise they won't light up.

Rostock MAX v2 Assembly Guide

The flat side of the LED is the “cathode” or negative (-) side. You want to insert the diode in the holes with the cathode lined up with the square pad as shown below. The silk screen also shows a flatted outline that matches that of the LED base.

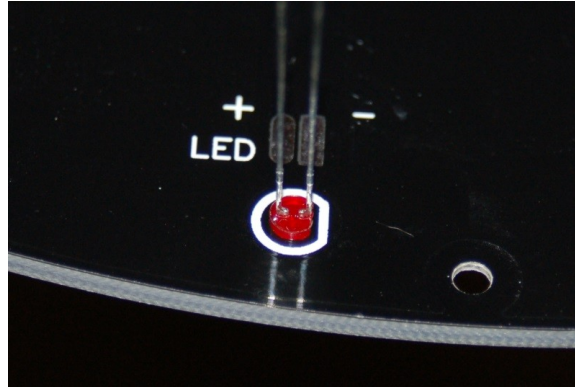

Fig. 5-9: LED orientation.

Bend the leads over so they are laying flat against the two solder pads as shown below and then solder them into place. If you hold the rim of the LED in place with your thumbnail while you bend the leads over, you'll end up with a nice “ramp” to the leads as shown in Fig. 5-10.

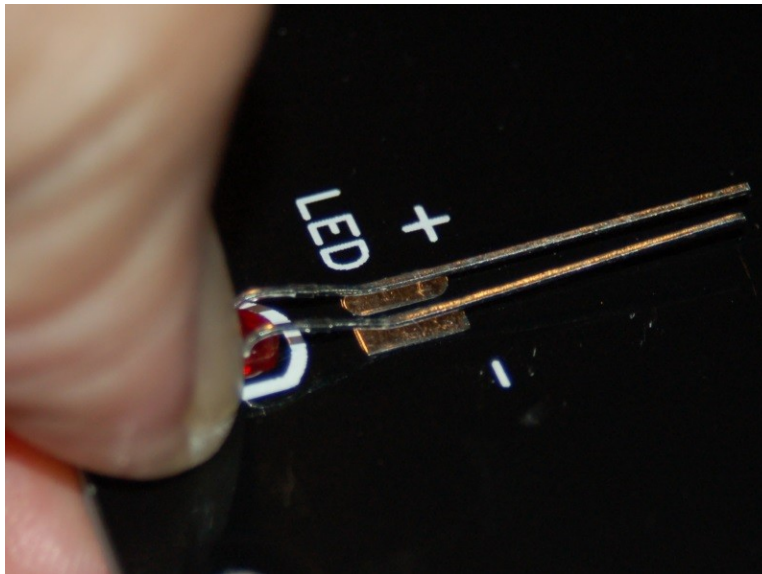

Fig. 5-10: LED ready to solder in.

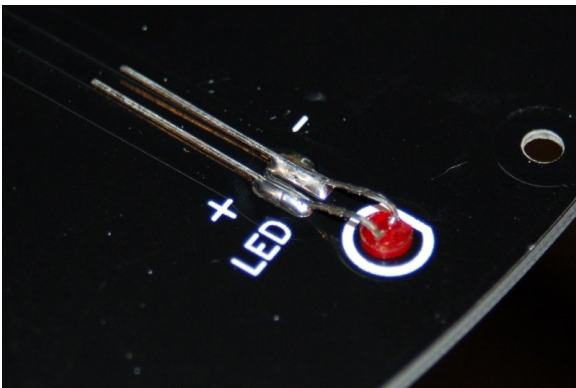

Fig. 5-11: Leads soldered into place.

Rostock MAX v2 Assembly Guide



Fig. 5-12: ...and trimmed.

Once you're done installing the LED, you'll notice that it sticks up past the top surface of the Onyx. The LED needs to be pushed in so it's flush or slightly below the top surface of the Onyx, as shown below.



Fig. 5-13: Correct LED depth.

The next step is to install the resistor that the Onyx power LED needs to operate. Take one of the resistors from the package and bend the leads as shown in Fig. 5-14.

Rostock MAX v2 Assembly Guide

Lay the resistor down on the bottom of the Onyx as shown and solder into place and trim off the excess leads.

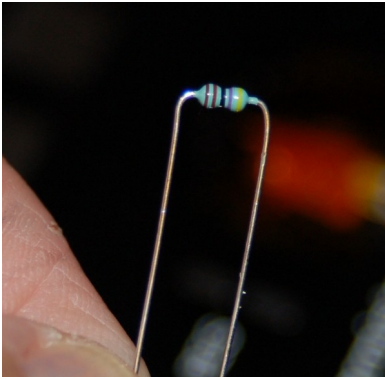

Fig. 5-14: Properly bent leads.

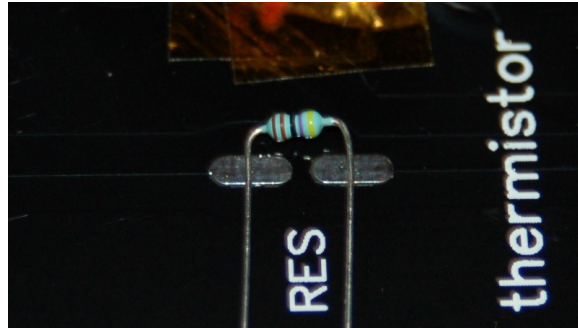

Fig. 5-15: Ready for soldering!

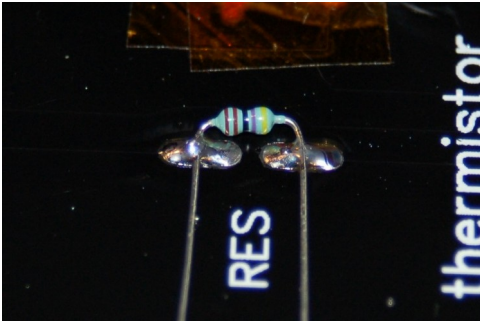

Fig. 5-16: Soldered and ready to trim.

Now grab the 18ga, four conductor wire included in the wiring pack and cut a section 17" long from it.

The 18ga wire is easy to identify – it's got "18 AWG" printed in a repeating pattern all along the outer jacket.



Fig. 5-17: Identifying the 18ga wire.

Strip the gray insulation off the four wires. You can discard the single bare wire and the thin

Rostock MAX v2 Assembly Guide

aluminum inner jacket. For this task we'll only be using the red & black wires. The other two can be discarded. The red & black wires are going to be soldered to the bottom of the Onyx and will supply power to it.

Strip about 1/2" of insulation off the red wire and set it in place on the middle of the square pad with the "+" symbol next to it. (The "+" indicates that this is the Positive connection.)

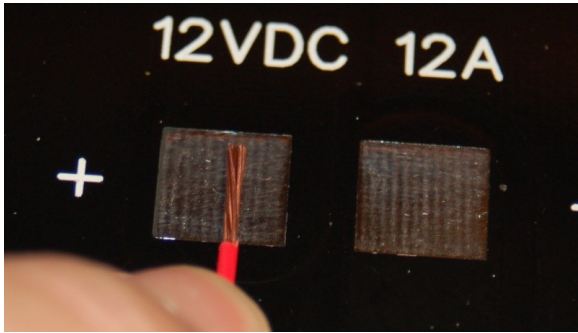

Fig. 5-18: Ready to solder.

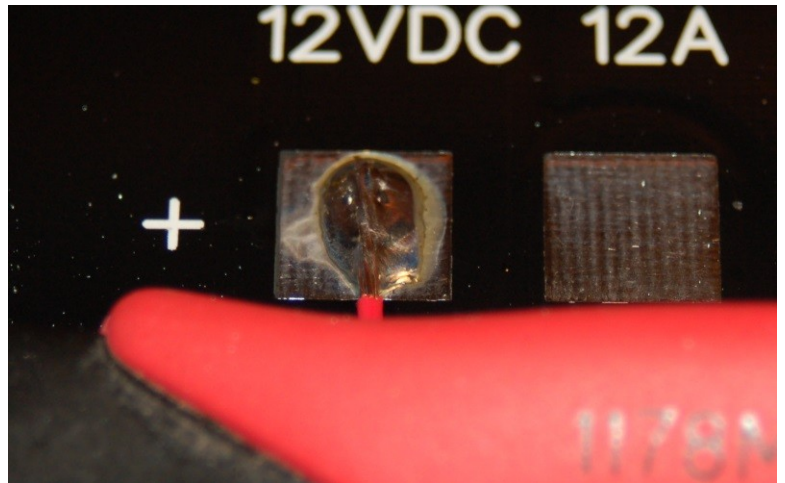

Fig. 5-19: Soldered in place.

You may need to use something to hold the wire into place while you solder it. I used a pair of wire cutters to weight it down.

Now perform the same task with the black wire. The black wire will be soldered to the pad marked with the "-" symbol. (The "-" symbol indicates that this is the Negative or Ground connection.)

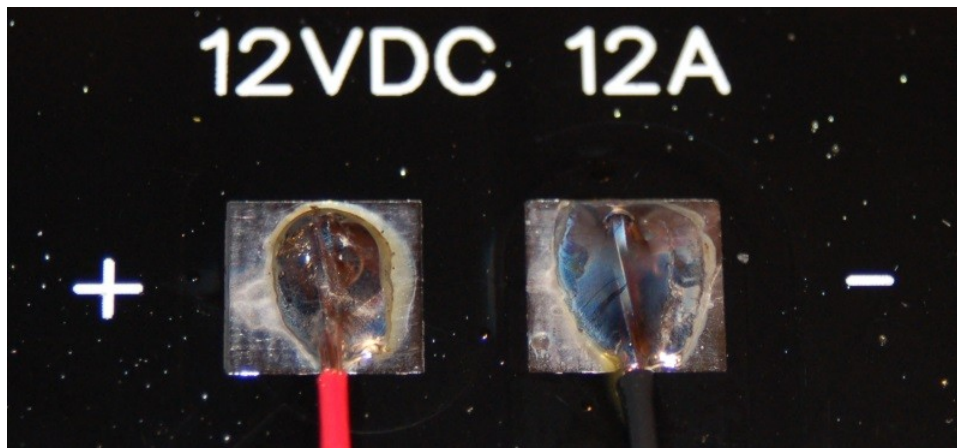

Fig. 5-20: Onyx power leads soldered into place.

Rostock MAX v2 Assembly Guide

Now you need to attach the thermistor signal leads. You'll find them in the box that the RAMBo came in.



Fig. 5-21: Thermistor wire bundle.

The thermistor signal leads are wrapped up in a bundle and there's two lead pairs there. Each pair has a 2 pin connector on one end. You'll only need one of them for this task. Return the other one to the wiring bag.



Fig. 5-22: Single thermistor signal lead.

Strip about 1/8" of the insulation of the bare ends of the thermistor wires and solder them on top of the solder pads that are aligned with the two solder pads you soldered the thermistor to. One wire per pad and take care to avoid solder bridges.

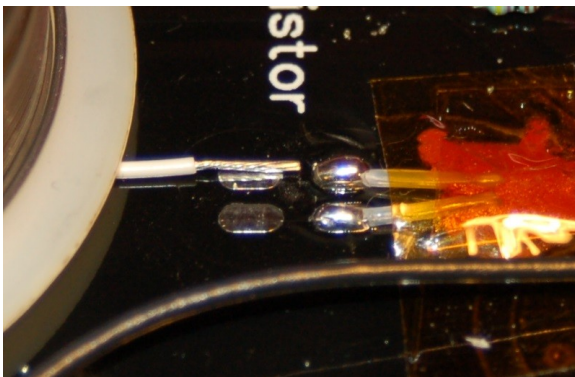

Fig. 5-23: Ready to solder!

Make sure there's no blob of solder bridging the two pads or the thermistor won't operate!

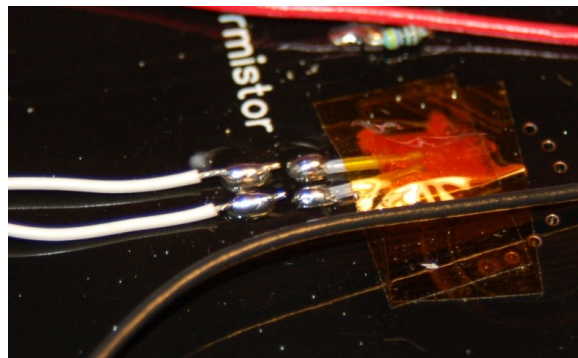

Fig. 5-24: Soldered and ready to trim.

Rostock MAX v2 Assembly Guide

The last task to finish off the wiring is to cover all the exposed connections with Kapton tape. This will help insure against any accidental shorts. The tape will also act as a bit of strain relief for the wiring.

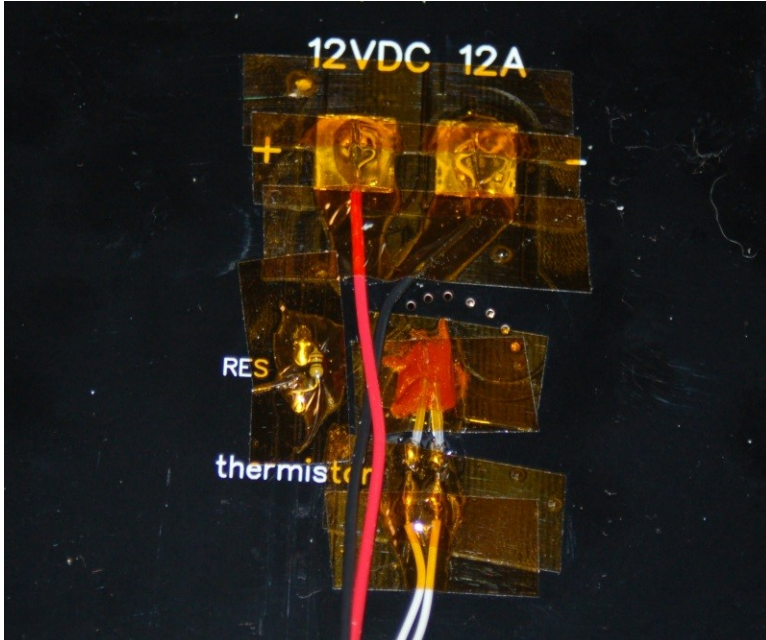

Fig. 5-25: Main bed connections covered.

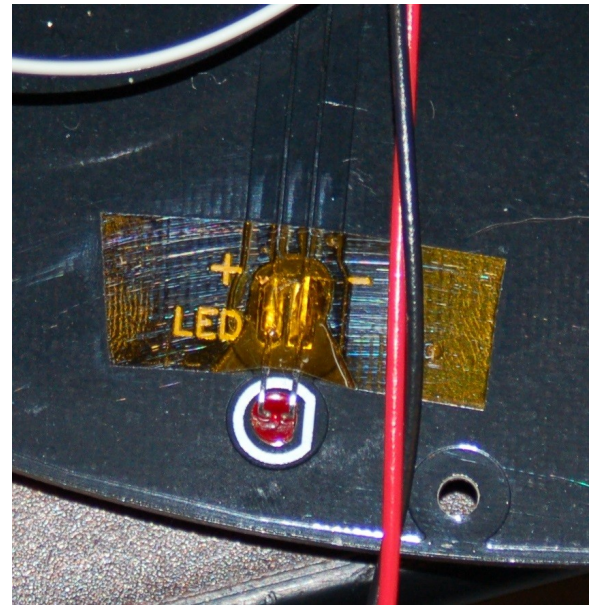
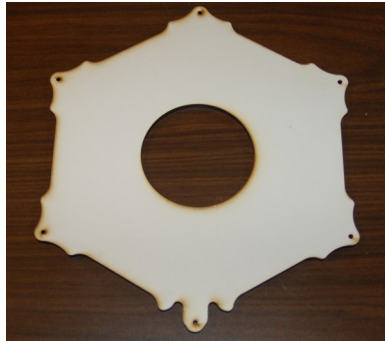

Fig. 5-26: LED covered.

Mounting the Onyx Heated Bed to the Base

For this task, you'll need the following components:



Completed Onyx.

In order to mount the Onyx on the base, you'll need to route the power and thermistor signal wires through the center of the “snowflake” mounting plate and the base as shown below.

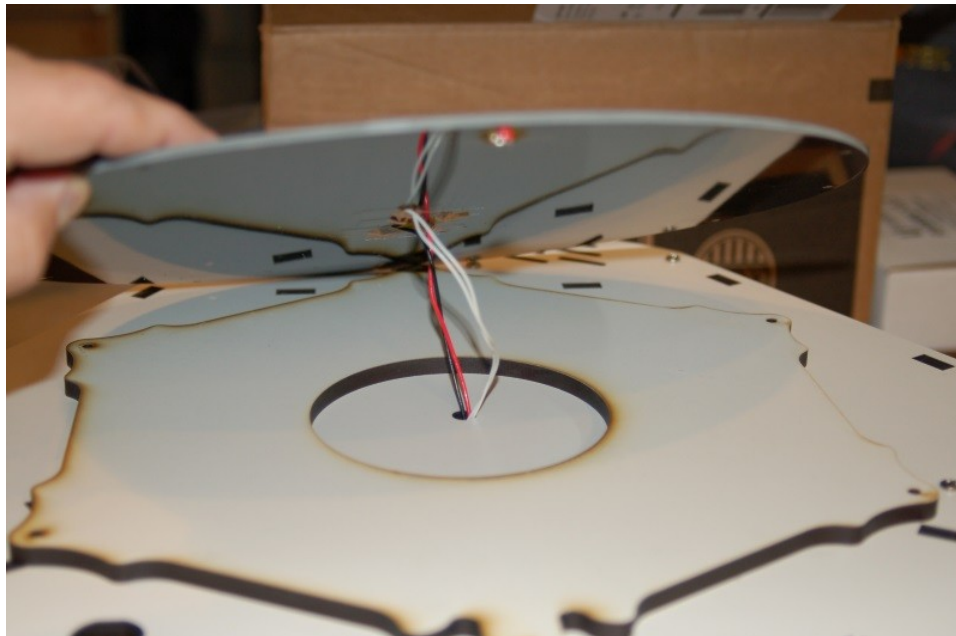

Fig. 5-27: Wires routed through the center hole.

Pull the wiring forward through the opening in the front facing vertical support in order to get them out of your way.

Rostock MAX v2 Assembly Guide

The mounting plate has a pair of notches that are designed to accommodate the LED. You need to orient that feature so that it points to the “front” of the machine.

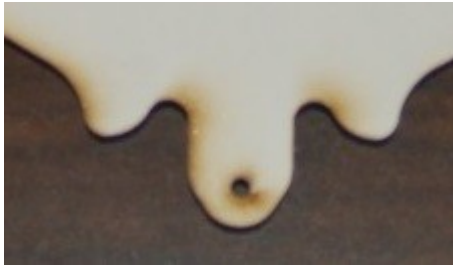

Fig. 5-28: LED notches.

Lay the Onyx heated bed on top of the mounting plate and rotate it so the LED is at the front. (The LED will be directly opposite the Z tower in the rear.)

Now it's time to attach the Onyx and its mounting plate to the base – grab the round nylon spacers and the six #4-40 flat head screws that were included with the Onyx.



Fig. 5-29: Nylon spacers.

Turn the Onyx so that the first hole lines up with the first hole in the mounting plate. (The first hole is the one between the two LED clearance notches.)

Slide a #4-40 screw through the Onyx & mount and slip on a nylon spacer.

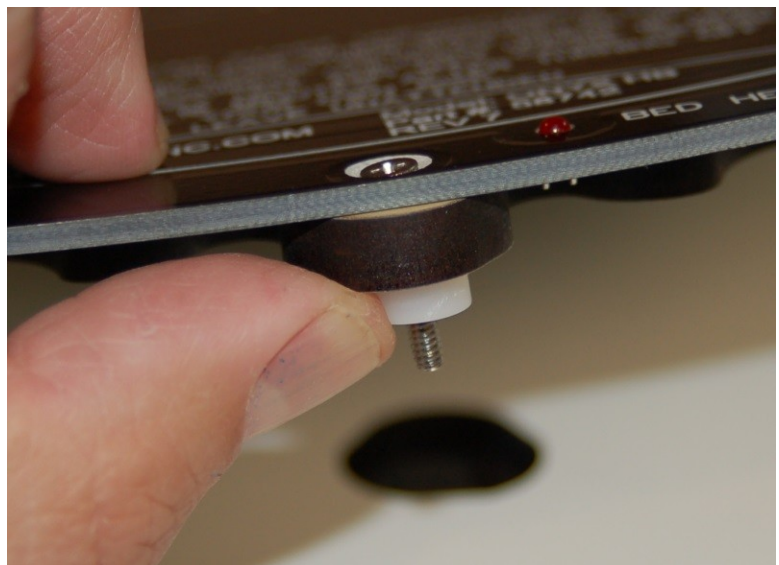

Fig. 5-30: Screw & nylon spacer on #1 hole.

Rostock MAX v2 Assembly Guide

Now set the Onyx & mount down so the screw will go through the #1 mounting hole as shown below.



Fig. 5-31: First screw in!

Tighten the screw a small amount. A half or three-quarter turn should do it. We just want it to grab enough threads to keep it from popping out while we line up the other five screws.



Fig. 5-32: Screw fastening order.

When you've got all six screws loosely installed, carefully take up any extra slack in the Onyx wiring by carefully pulling any extra through the center hole in the base. Tighten the six screws using the order shown in Fig. 5-32 above. This will help ensure that the Onyx remains as flat as possible when it heats. As you tighten each screw, make sure you only turn it a bit more than finger tight – if you apply too much force, the screw head will damage the Onyx.

Checkpoint Video #5: http://youtu.be/x_KUriGPn_4

6 – Installing the Towers & Tower Wiring

Running Wire in the Towers

For this task, you'll need the following components:



3 Aluminum Towers



18ga, 4 Conductor Wire



22ga, 4 Conductor Wire



26ga wire, Red & Black



End Stop Wires

Note that the end stop wires can be found in the same bag that contained the thermistor leads.

The 26ga red & black wires are supplied as one continuous length. The wire is meant to be used to provide power for the PEEK and layer fans on the effector platform. Before you can run those wires in the tower, you'll need to cut the red & black wires in half so you have two red & black pair of equal length.

In the Rostock MAX v2, you'll be routing the hot end, extruder stepper and end stop wiring through the center of the three towers. If you're upgrading a Rostock MAX v1 and using the original towers, please make sure to gently file off any sharp edges on either end of each tower.

In order to do this, you're going to have to strip the outer jacket from both four conductor cables. This is very easy to do, but there IS a bit of a trick to it. :)

Rostock MAX v2 Assembly Guide

Inside each cable is a very thin, very strong Nylon string. You're going to use this string to split the gray outer jacket of the cable along its full length. Strip the 18ga, 4 conductor wire now and we'll get to the 22ga wire in a bit.

Start by carefully removing about 6" worth of the outer jacket by using an X-Acto knife to score the jacket all the way around. When you've got it scored, pull the end away from the rest of the cable and the jacket should come off at the score line.

You'll be left with four colored wires, a bare wire, a very thin foil wrap and that magic little Nylon string. Wrap the string around your fingers to get a good grip on it and holding the exposed wires in one hand, pull the Nylon string away from you, along the length of the cable. Continue doing this until it's split the whole gray outer jacket.



Fig. 6-1: Splitting the outer insulation.

When you're done, you can discard the outer jacket and the thin aluminum wrap. However, don't discard the bare wire that was woven around the four conductors. You're going to use that shortly as a pull line to get the thinner wires down the towers.

The Z axis tower will get the 18ga hot end wires, the X axis tower will get the end-stop wires and the Y axis tower will get the 22ga wires for the extruder as well as two pair of 26ga wires for the PEEK fan and the layer fan.

The 18ga wire is the largest in diameter, followed by the 22ga wire and the 26ga wire is the thinnest.

Rostock MAX v2 Assembly Guide

The 18ga, four conductor cable is the first one we're going to use. When you're done stripping it, you should have something like this:

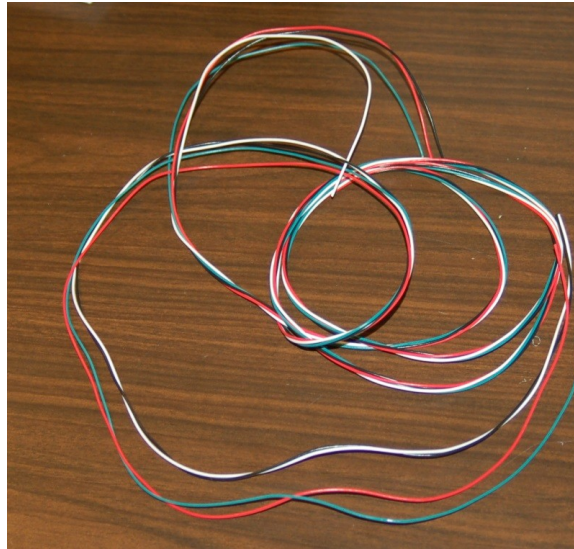

Fig. 6-2: 18ga wires.

Take one of the aluminum extrusions and thread this wire right through the small channel in the center of the tower. Turning the wire counter-clockwise will help this process along.

When you're done, it should look like the image shown below.



Fig. 6-3: 18ga wires routed.

Because the 18ga wire is pretty stiff, you should be able to run it inside the tower pretty easily. Just do it an inch at a time to take advantage of the greater stiffness afforded over a shorter length of wire. If you're unable to do it, you can skip ahead to the next page and see how the bare wire you saved is used as a “fish” wire.

Rostock MAX v2 Assembly Guide

Pull enough of the 18ga wire so that the end coming out of the “top” comes within about 6” of the “bottom” of the tower. This will give you plenty of room for wiring up the hot end.

Now you'll route the end stop wires. Carefully stretch out the three wire pairs included in the bundle and spindle the ends together as shown in Fig. 6-4.



Fig. 6-4: End Stop wires bundled together.

Now thread the bare wire you recovered from the 18ga, 4 conductor cable through the center of the next tower. When you've pulled it all but about four inches, wrap the wire around the spindled end of the end stop wires as shown below.

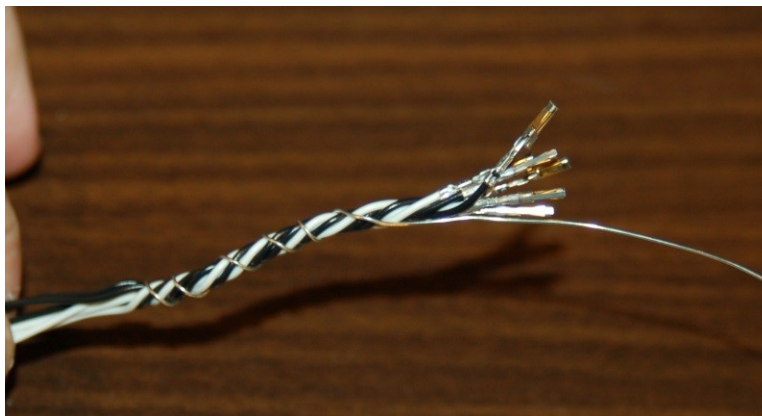

Fig. 6-5: Bundle ready to pull.

Rostock MAX v2 Assembly Guide

Now carefully stuff the wires into the center opening in the tower, while gently pulling on the bare wire coming out the other end of the tower.

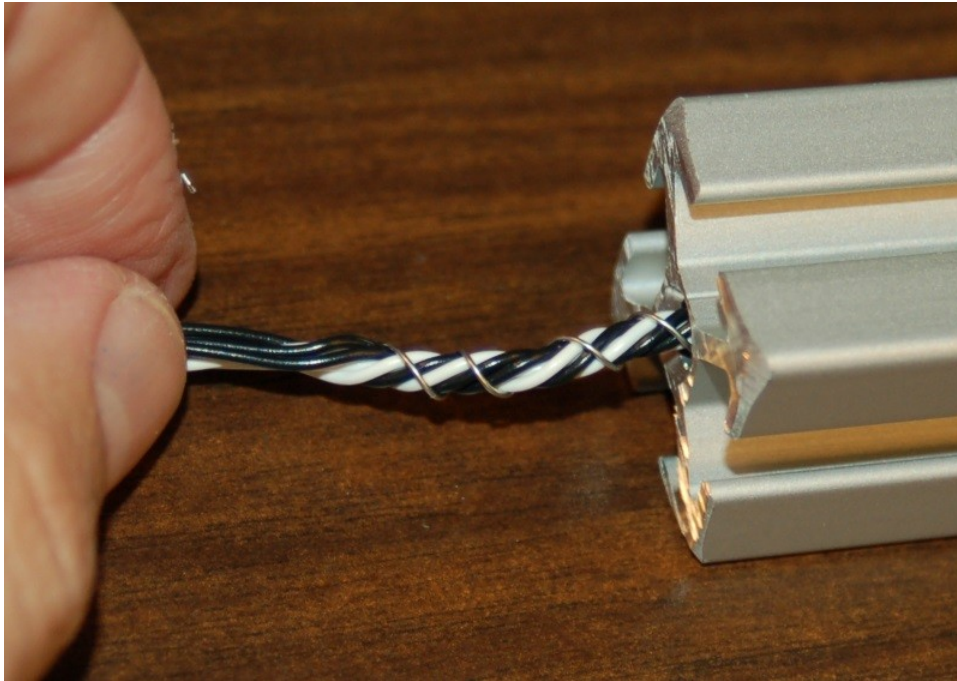

Fig. 6-6: Getting it started.



Fig. 6-7: Done!

Rostock MAX v2 Assembly Guide

Now remove the bare wire and set it aside – we'll use it again next, but first you need to identify and mark each pair of the end stop wires.

You can easily identify which wire is which by gently pulling on one end and observing which wire moves. When you think you've identified a wire, grab the other end and see if pulling it back and forth through the tower works as you expect it to – you should feel yourself pulling the wire from either end. Once you've identified your first black & white pair, write an “X” on the spade connector using a Sharpie or other indelible marker. At the opposite end, twist the wires together about 1/4” from the end of the crimp on connector and label it.

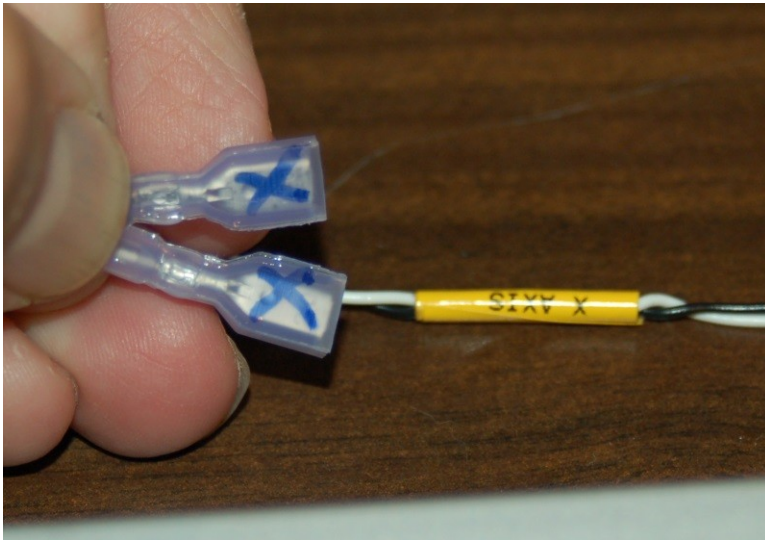

Fig. 6-7: X Axis end stop wires labeled.

When you've got both ends marked, tie a very loose knot in the top pair as shown to the right. Repeat this identification and labeling process for the other two end stop wire pairs. You'll mark the second as the “Y” axis and the third as the “Z” axis.

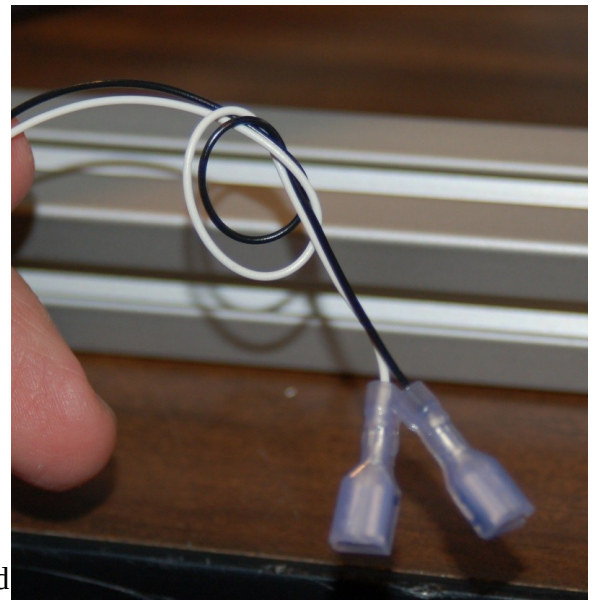

Fig. 6-8: End stop wires paired.

Rostock MAX v2 Assembly Guide

Now grab the 22ga, four conductor cable and strip the jacket off of it if you haven't already.



Fig. 6-10: Identifying the 22ga, 4 conductor wire.

Once you've got the 22ga wire stripped out of the outer jacket, you'll want to grab the two pair of red & black wires you made up previously. Spindle them together with the four conductor, 22ga wire as tightly as you can. Thread the bare wire through the last tower like you did previously and wrap the end around the spindled portion of the 24ga & 26ga wires.

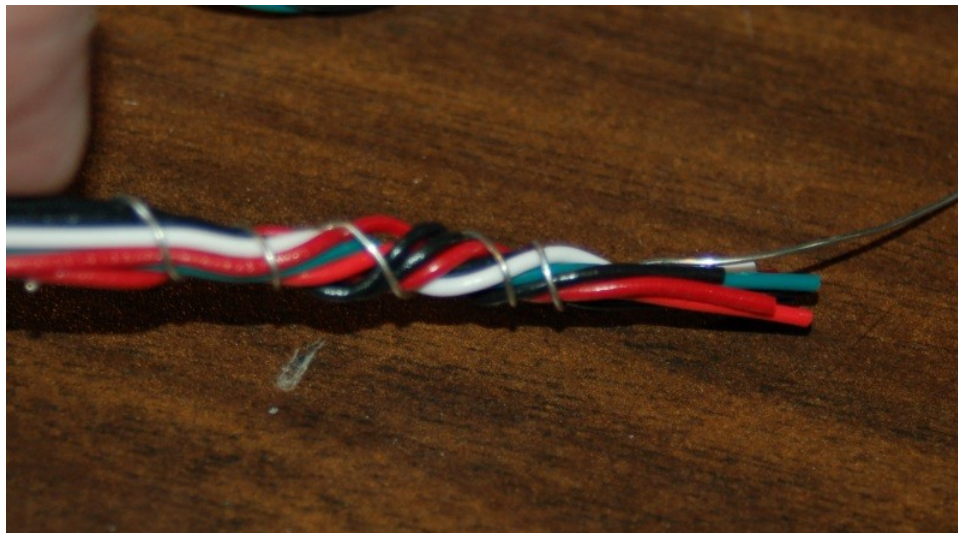

Fig. 6-11: 26ga & 24ga wires ready to pull.

Just as you did with the end stop wires, carefully feed the wire bundle into the center hole and as you gently pull on the end of the “fish” wire.

Rostock MAX v2 Assembly Guide



Fig. 6-12: Success!

You now need to identify the red & black wire pairs that were routed along with the other wires. Use the same method as used on the end stops and tie a knot in *one* pair of black & red wires at both ends. This knotted pair will be used for the PEEK section fan, the un-knotted pair will be used for the layer fan.



Fig. 6-13: PEEK fan wires knotted.

Setting the Towers

Now it's time to set each tower in its respective tower support assembly.

We're going to start with the Z axis.

In order to set the Z axis tower (the one with the 18ga wires!), you'll need to turn the T-Slot nut plates such that they're oriented vertically as shown below.

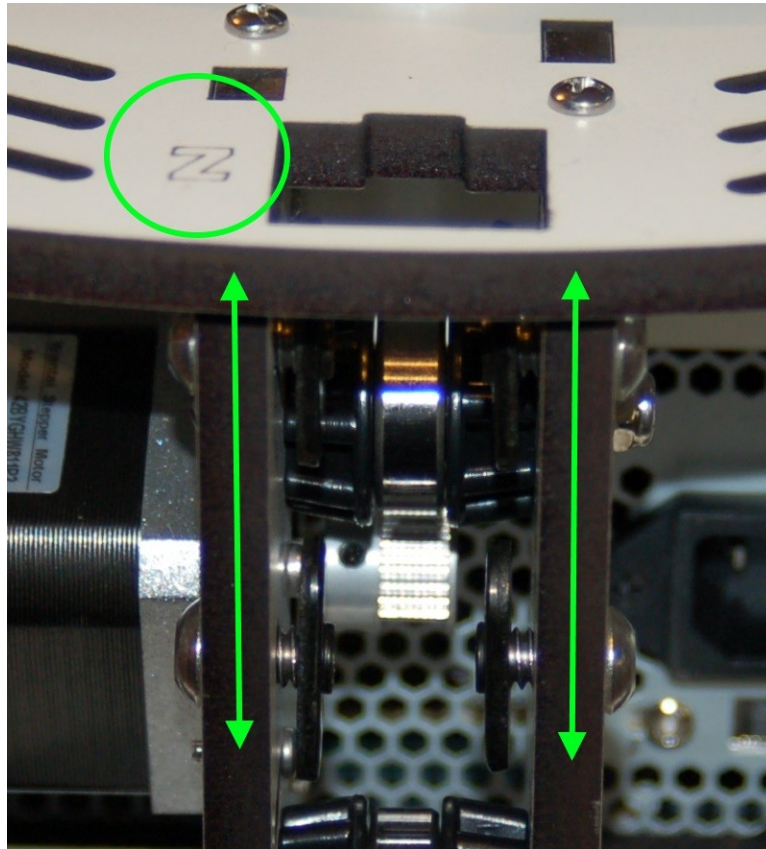

Fig. 6-14: T-Slot nut orientation on the Z axis.

Rostock MAX v2 Assembly Guide

Next, you're going to thread the wires coming out of the Z axis tower through the square opening in the top of the base that's right over the T-Slot nut plates.

Now carefully set the end of the tower in the opening and slide it in. It's a VERY tight fit but do not wiggle it! You want to drive the tower straight down. If you wiggle it front to back too much, you can break the area where it's thin at the corners of the hole.

As you drive the tower down, make sure that the T-Slot nut plates are sliding into the t-slots on both sides of the tower. You'll want to drive it down until it comes into contact with the #4 leveling screw that you installed in the tower assembly. After the tower is set, use a 5/32 Allen (hex) wrench to slightly tighten the 1/4-20 cap screws (finger tight). You'll tighten them up after the top as been mounted.

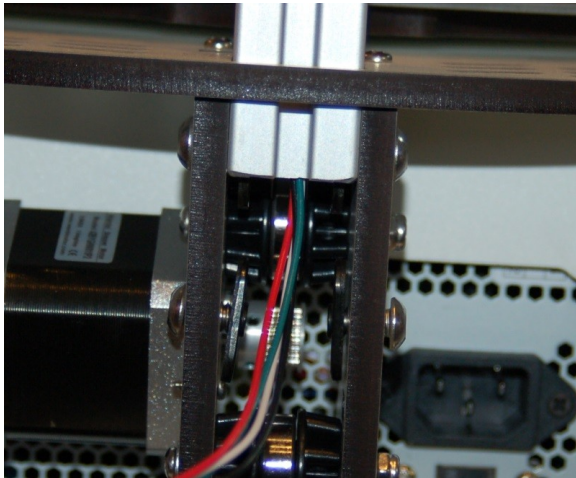

Fig. 6-15: Setting the Z tower into place.

Once the tower has covered the upper half of the lower t-slot nuts, route the wires through the rounded slot on the right side of the tower support, as shown.

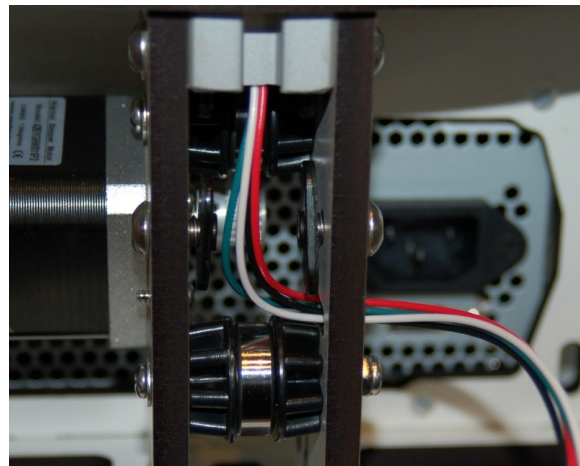

Fig. 6-16: Wire route.



Fig. 6-17: Tower fully seated, resting against the stop screw.

Rostock MAX v2 Assembly Guide

Now you can route the Z axis wiring forward through the space on the right of the tower as shown below.

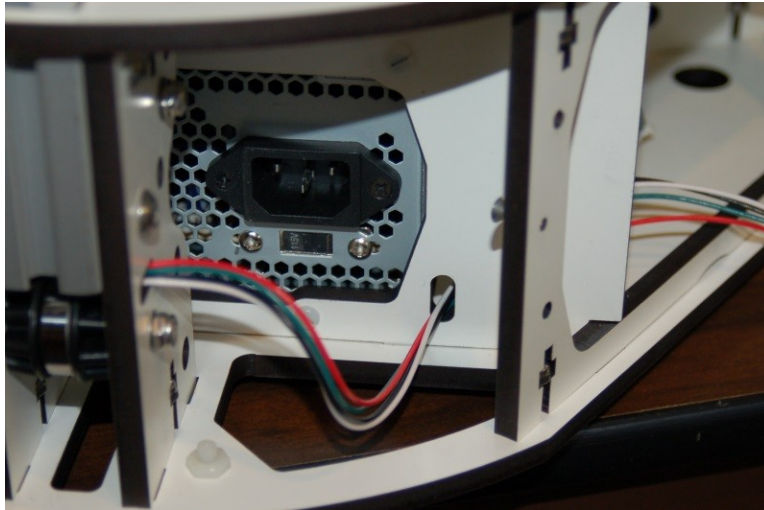

Fig. 6-18: Routing the Z axis wires forward.

The X and Y towers are set in a similar fashion. The end stop wires in the X axis tower also route through the right side rounded slot as shown.

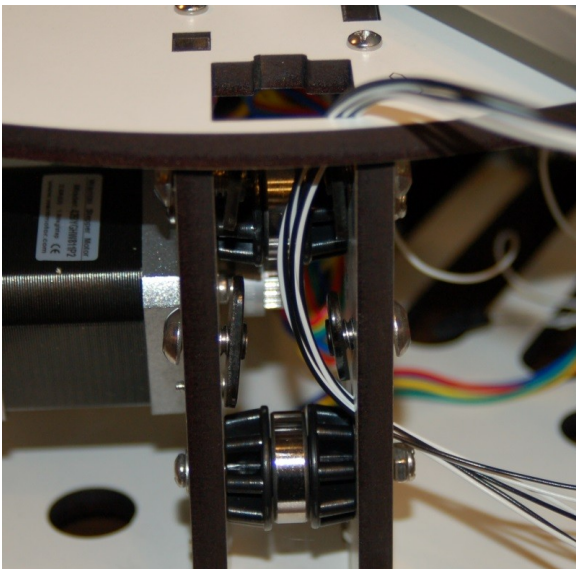

Fig. 6-19: X axis wire route.

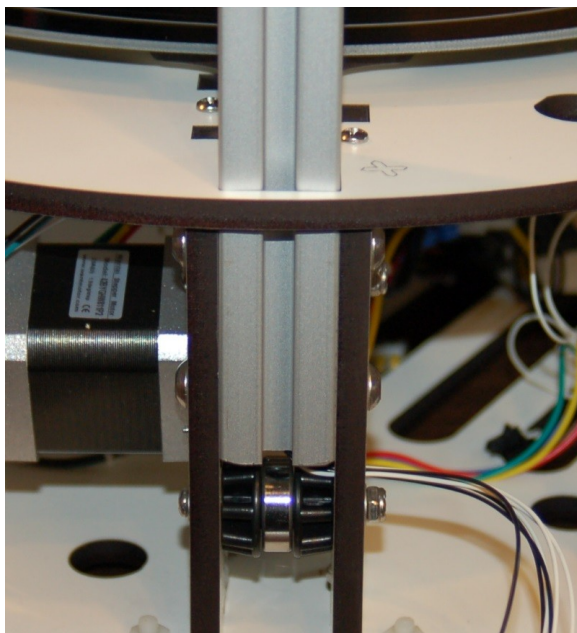

Fig. 6-20: X axis tower set in place.

Rostock MAX v2 Assembly Guide

Now you can set the Y axis tower in to place. Unlike the Z and X axes tower wiring, the Y axis tower wires exit to the left as shown.

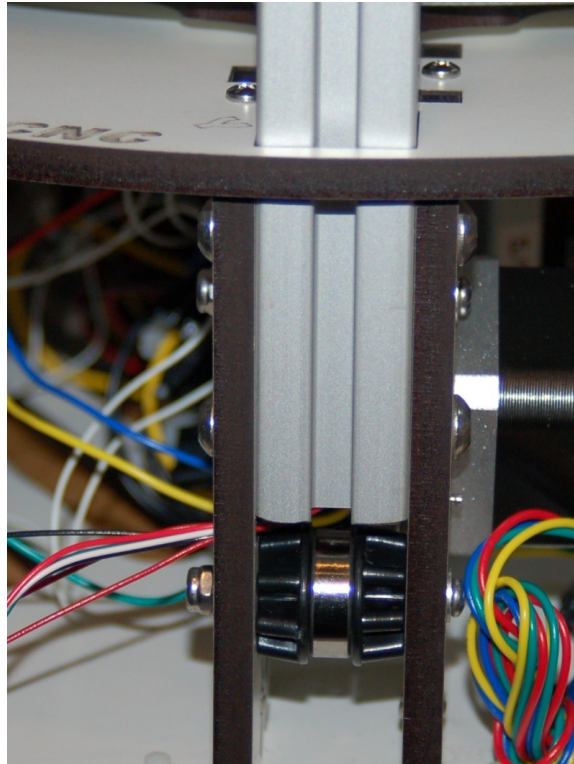
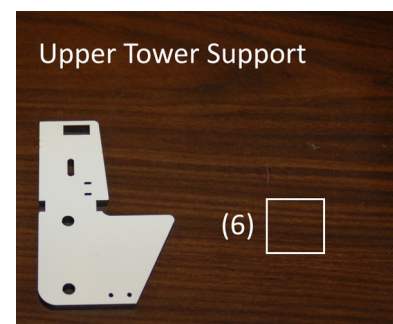
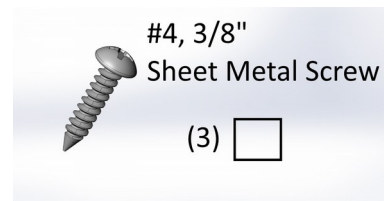
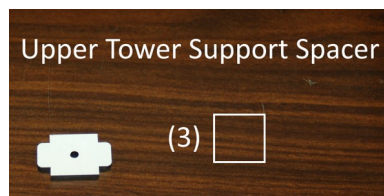
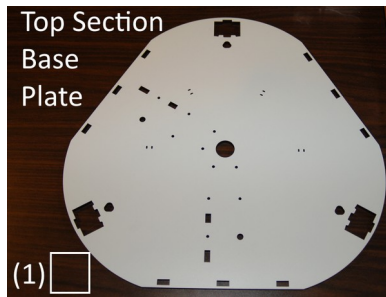

Fig. 6-21: Y axis wiring route.

Checkpoint Video #6: <http://youtu.be/qbtiOqR6aZQ>

7 – Assembling, Installing, and Wiring the Top Section

For this task, you'll need the following components:



When I originally built the printer for this manual, I made a silly mistake. I put the top on backwards. This doesn't affect the operation of the printer at all, it just looks silly. In order to make sure you don't make the mistake, take a look at the image below.

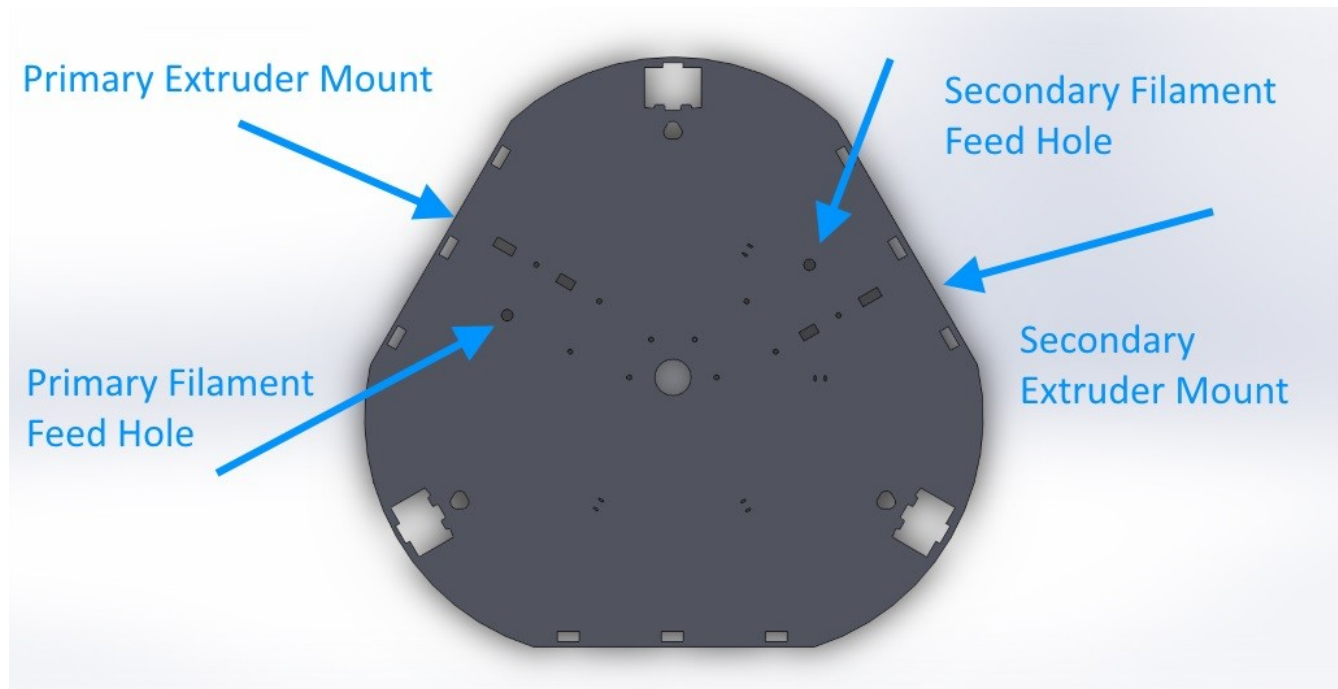

You'll want to orient the top section base plate as you see above. This will help ensure that YOU don't build yours backwards like I did. I've revised many of the original images that show the reverse orientation, but not all of them. As long as you follow the guide above, you'll be fine!

Prepping the Upper Tower Mounts

Before you can install the upper tower mounts, three tower depth stop screws need to be installed as shown below.

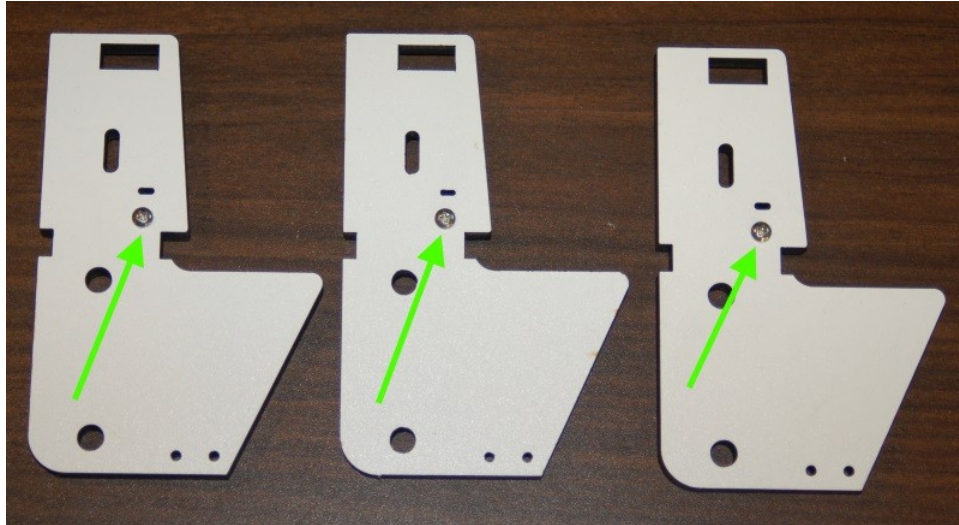

Fig. 7-1: Depth stop screws installed.

These screws perform the same function as the ones previously installed in the lower tower mounts. This helps guarantee that the top section will be at the correct height on all three towers.

Installing the Upper Tower Mounts

The upper tower mounts don't fit in the tower sockets without being a bit clever in the installation process.

Take two upper tower mounts (**make sure the one on your left has a tower depth stop screw installed!**) and set them into the tower socket as shown in Fig. 7-2.

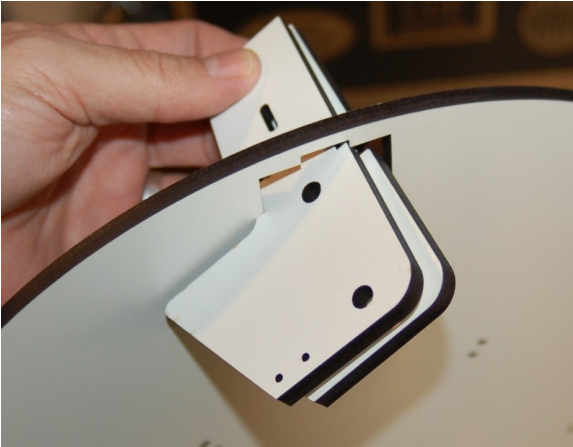

Fig. 7-2: Staging the tower mounts.

Once you've gotten them "staged" as shown, carefully rotate them counter-clockwise until both parts are in the position shown in Fig. 7-3.



Fig. 7-3: Rotating the mount pair.

Now rotate the left mount until it's firmly against the side of the notch as shown in Fig. 7-4.

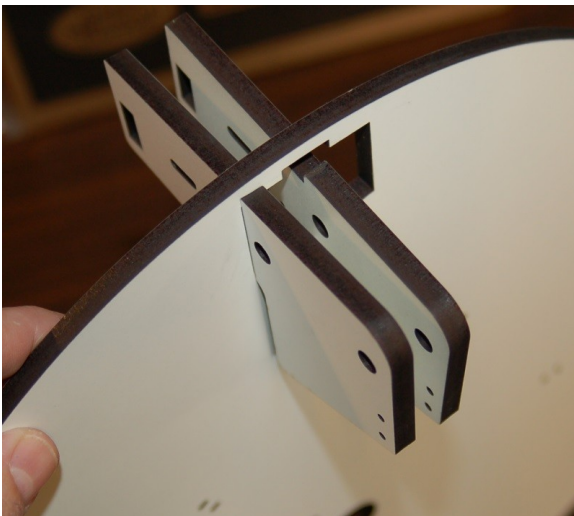

Fig. 7-4: Left mount in place.

Rostock MAX v2 Assembly Guide

Now you'll rotate the bottom of the right mount so that it's in the position shown in Fig 7.5.

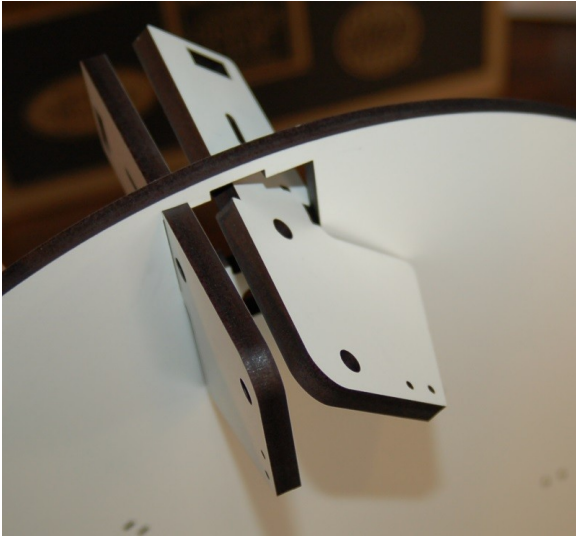

Fig. 7-5: Right mount rotated.

Rotate the mount clockwise until the right face of the mount is flush with the right side of the notch.



Fig. 7-6: Mounts in place.

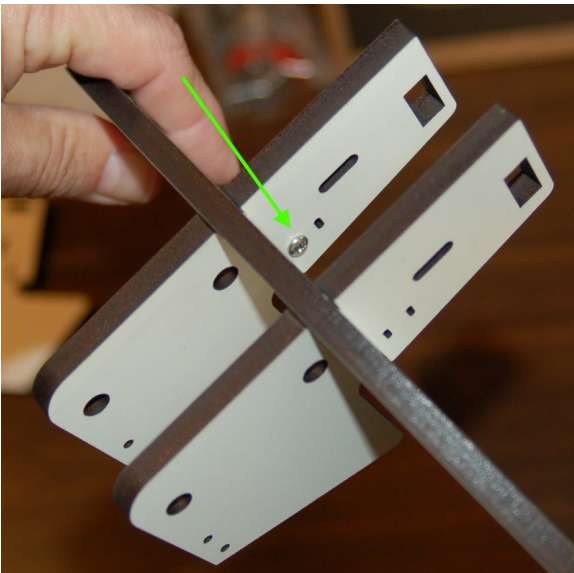

Fig. 7-7: Note location of the depth stop screw.

Repeat this process for the remaining two tower locations.

Rostock MAX v2 Assembly Guide

Now you want to insert one of the tower mount spreader blocks as shown below.

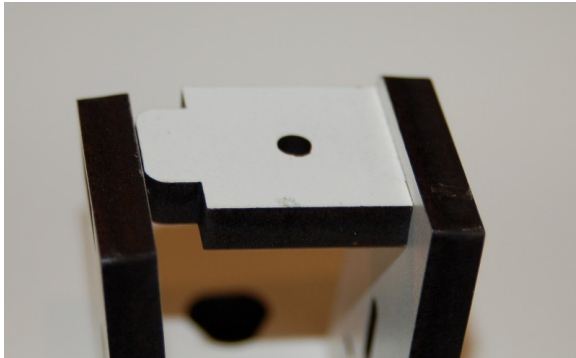

Fig. 7-8: First tab inserted.

The fit is very tight and requires that you spread the mount apart at the very ends to get the first tab of the spreader block set. It WILL fit, but be careful – you don't want to break the tower mounts.

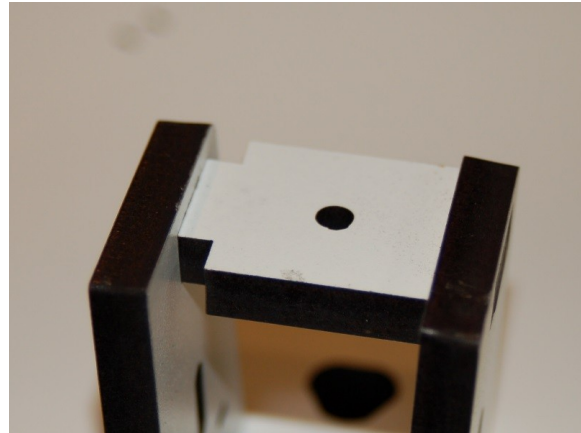

Fig. 7-9: Second tab set in place.

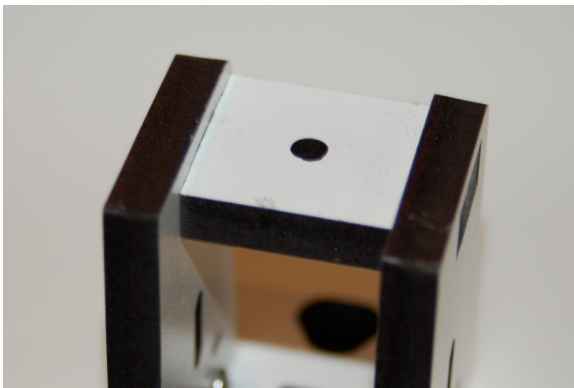

Fig. 7-10: Spreader fully seated.

Repeat the process for all three upper tower supports.

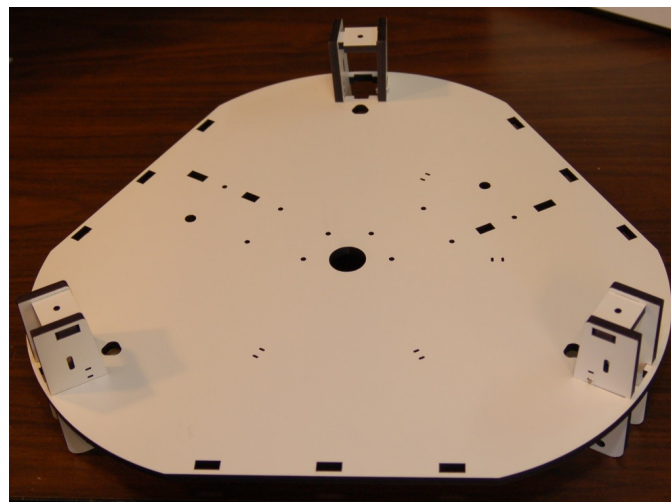
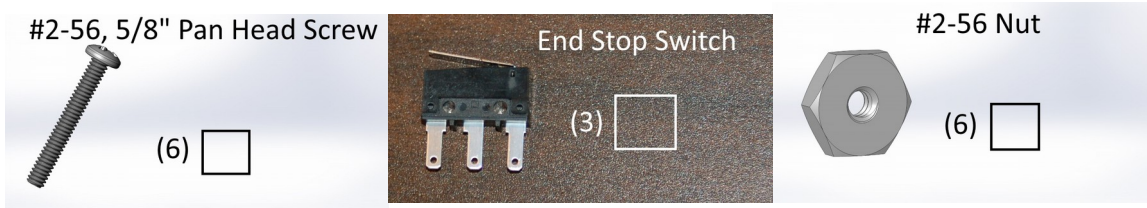

Fig. 7-11: Completed support installation.

Installing the End Stop Switches

For this task, you'll need the following components:



The end stop switches can be found in the zip lock baggie included with the RAMBo board.

Start the installation by inserting two #2-56, 5/8" pan head screws into the mounting holes on the right side of the over-turned tower mount as shown in Fig. 7-12.

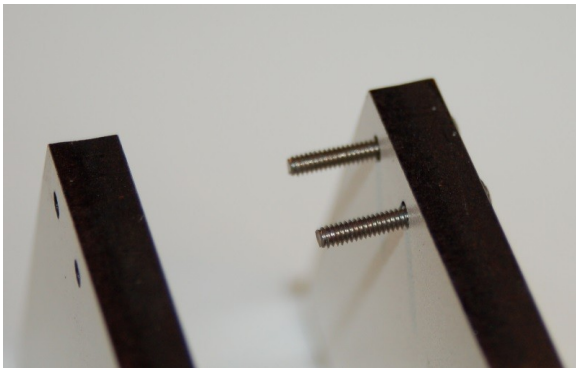

Fig. 7-12: End stop screws.

Finally, install one #2-56 finish nut on to each mounting screw.



Fig. 7-14: Nuts installed.

Next, you'll slide the end stop switch over the two screws. Make sure you've got the switch properly oriented. The back of the switch should be closest to you as shown.

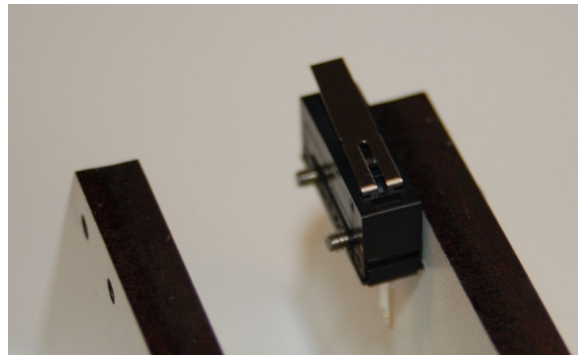

Fig. 7-13: End stop switch.

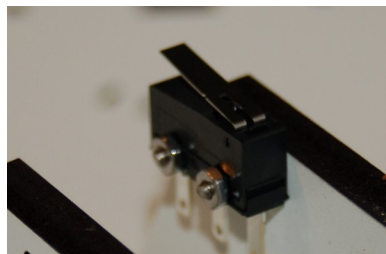

Fig. 7-15: Done!

Take special care to not over-tighten the screws or you'll crack the switch body, which could cause it to malfunction.

Rostock MAX v2 Assembly Guide

When you're finished, the underside of the top plate should look like Fig. 7-13 below.

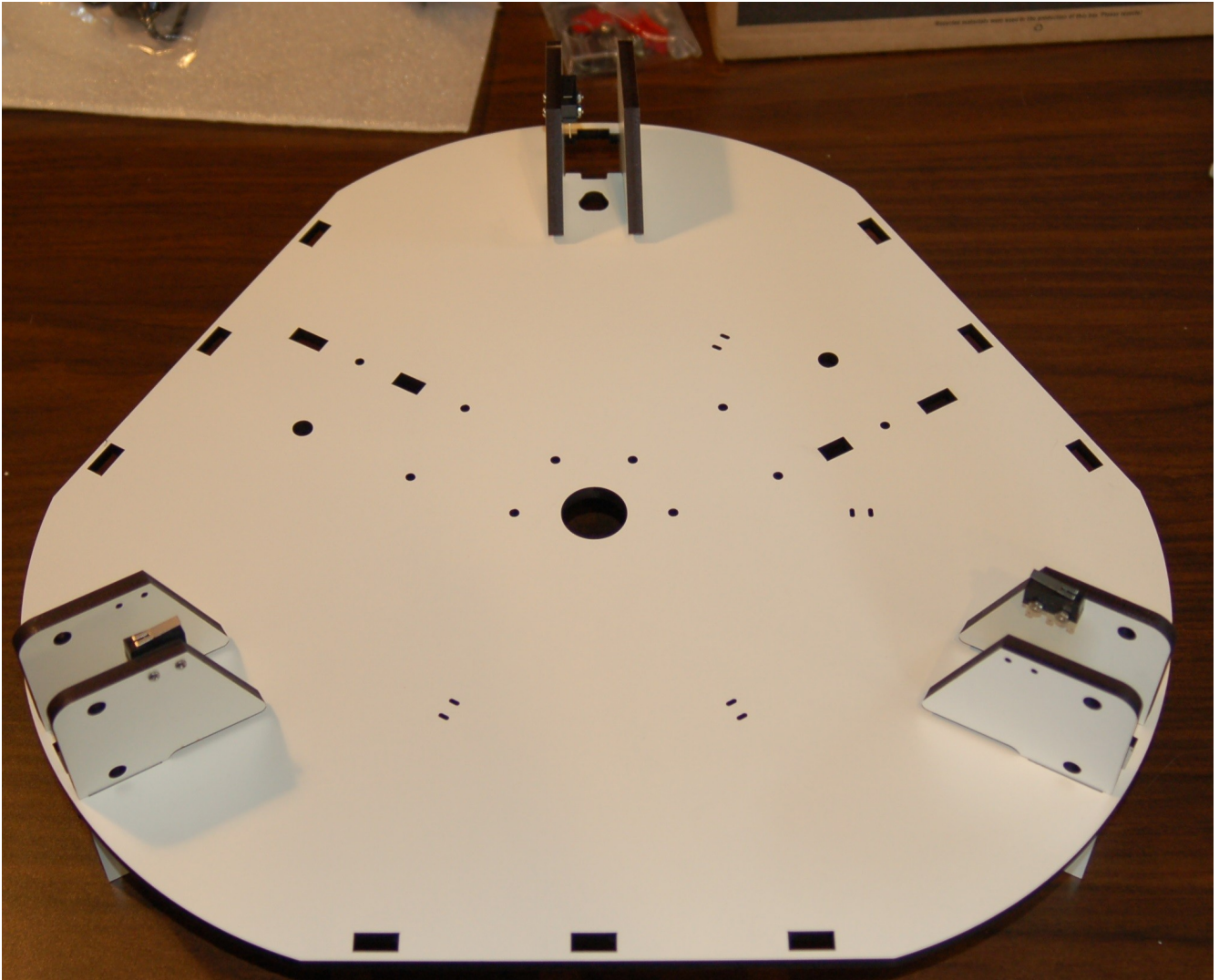
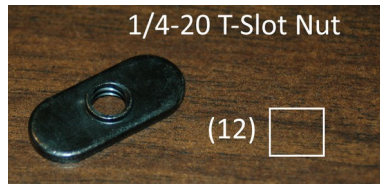
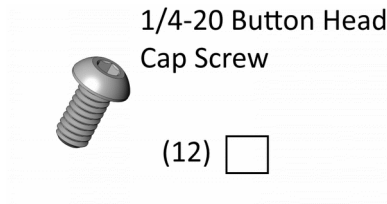

Fig. 7-16: Assembled top plate.

Installing the Upper Tower Mounting Hardware

For this task, you'll need the following components:



Install four ¼-20 button head screws and four T-Slot nut plates into each upper tower support as shown in Fig. 7-17.

Thread the nut plates only a couple of turns – they need to be as loose as the lower ones were in order to properly fit the towers.

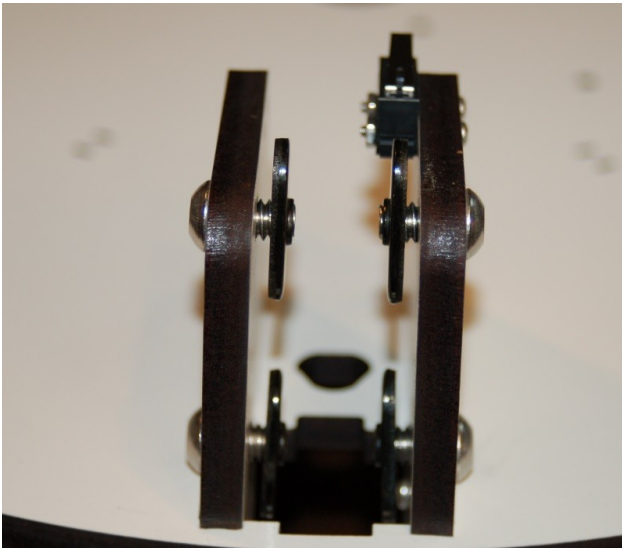

Fig. 7-17: Hardware installed.

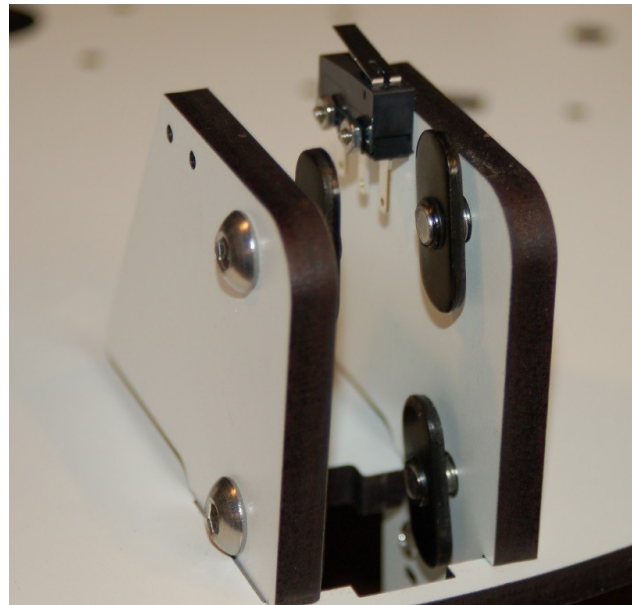
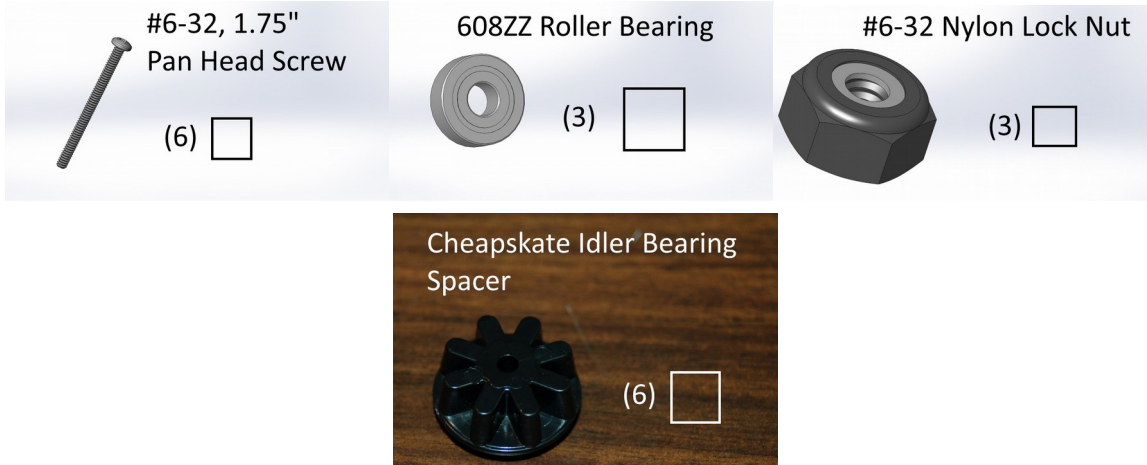

Fig. 7-18: Offset view.

Installing the Upper Idler Bearings

For this task, you'll need the following components:



First you'll need to put together two idle bearing spacers with one bearing. This is the same task you did for the lower idler bearings.



Fig. 7-19: Upper idler bearing.

Now install the assembled idler using a 1.75" pan head screw as shown below.

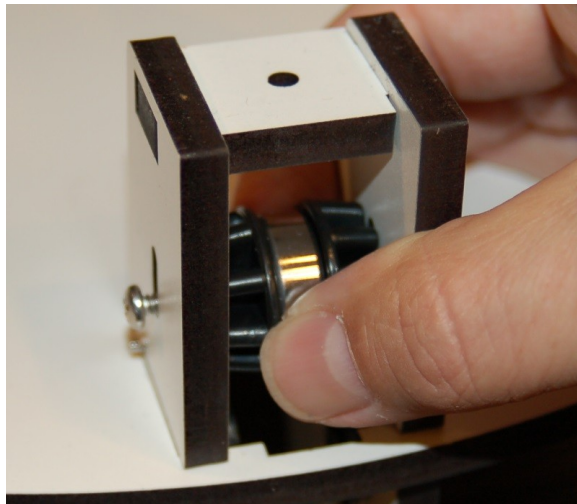

Fig. 7-20: Screw inserted.

Rostock MAX v2 Assembly Guide

Thread on a #6-32 nylon lock nut just finger tight – get it to bite into the nylon a bit, but no more. These will be tightened when it's time to tension the belts.

Install the other two idler bearings as you did this one.

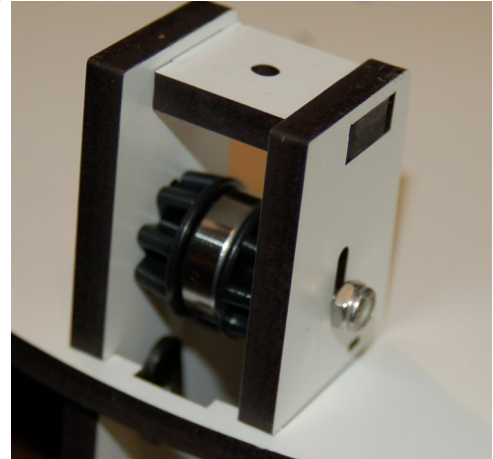
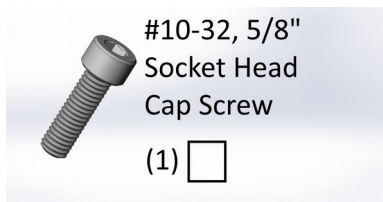

Fig. 7-21: Idler installed.

Checkpoint Video #7: http://youtu.be/QK_2V8QEu9A

A little prep work is in order...

Before you install the top plate on to the towers, there's one preparation step to do first. You'll notice that each of the upper support spacers has a hole in the center. This hole needs to be tapped in order to attach the top cover at the end of the build. Since we've got the top plate on the table, it'll be easy to do this task. You're going to need the #10-32 Socket Head Cap Screw to use as a tap.



Use a 5/32" Allen wrench to drive the screw in. Take care to make sure that the screw is going in as straight as you can make it. Once the screw comes through the other side by about 1/8", back it out and move to the next one.

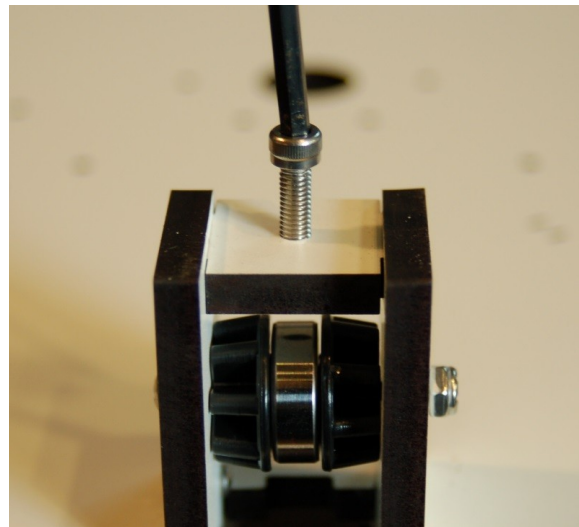

Fig. 7-22: Cutting threads.

Attaching the Top Plate

Installing the top plate is very simple, but it does take a little patience. Make sure that you've got the machine base turned so that the Z axis is farthest away from you and the X & Y axes are on your left & right, respectively. Rotate the top plate to match, as shown below.

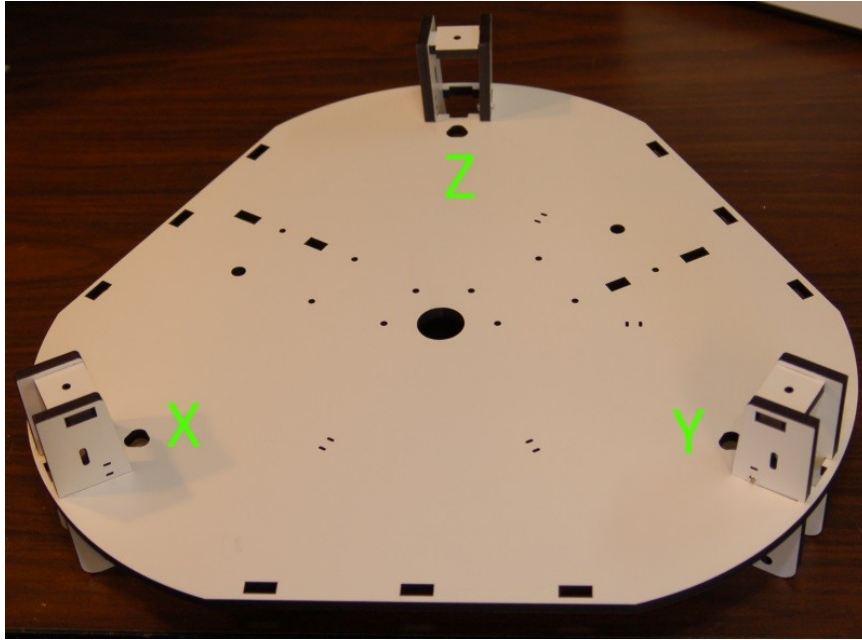

Fig. 7-23: Top plate ready for installation.

In order to give yourself room to route the wires through the tower openings in the top plate, you'll want to rest the plate on top of the towers. We'll start the installation with the X axis and the end stop wires.

Carefully route the end stop wires through the opening under the idler bearing as shown on the right.

Once you've got them run, move on to the Y axis.

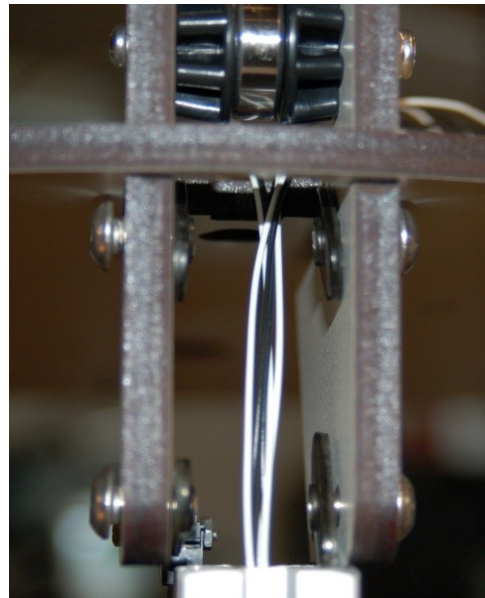

Fig. 7-24: Setting the X axis.

Rostock MAX v2 Assembly Guide

The Y axis carries the wires needed to drive the extruder stepper motor as well as the two pairs of wires needed to power the PEEK and layer fans. Go ahead and route the stepper motor wires up through the hole just as you did for the end stop wires. Since the wire gauge is very similar between the stepper wires and the fan wires, knot the fan wires loosely before routing them. It'll help you identify them later.

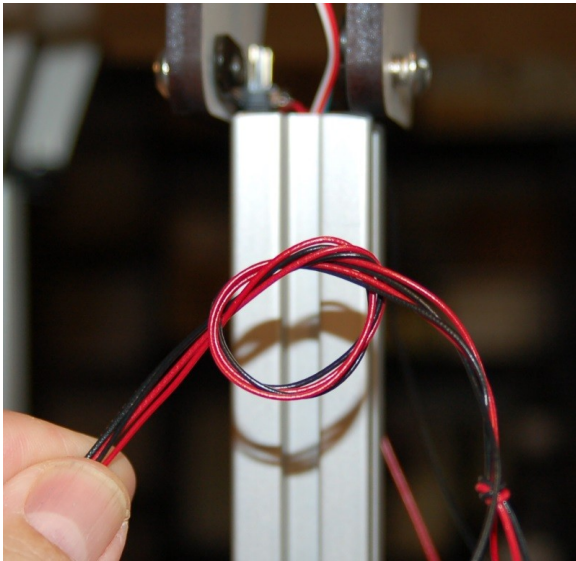

Fig. 7-25: Fan wires.

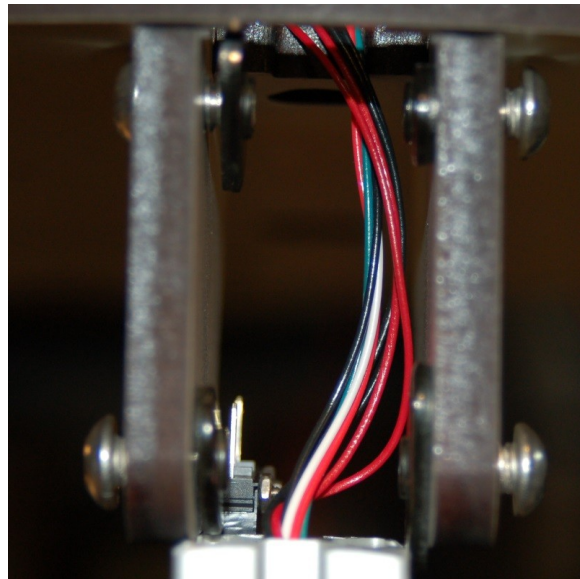

Fig. 7-26: Y axis wires routed.

Finally, route the Z axis wires as shown on the right.

Checkpoint Video #8:

<http://youtu.be/IIHX8W3uYdU>

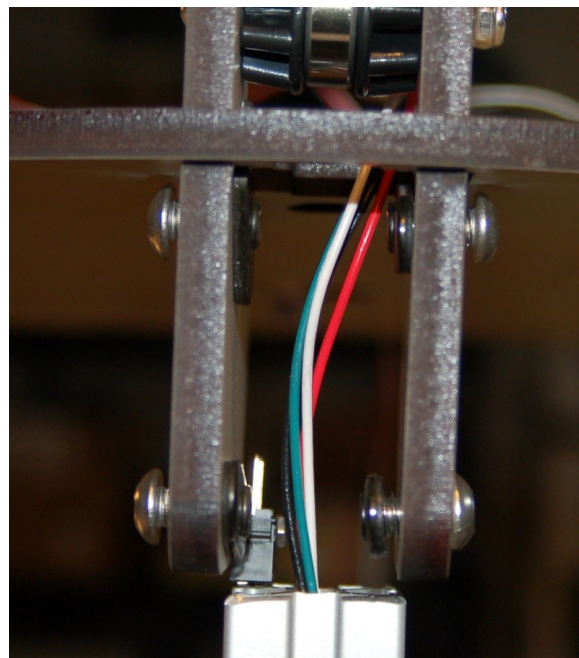

Fig. 7-27: Z Axis wires.

Rostock MAX v2 Assembly Guide

Now it's time to get the top plate settled down on the towers. Orient the t-slot nuts so they're pointed vertically. This should allow them to slide into the slots on the tower. We'll start with the Z axis.

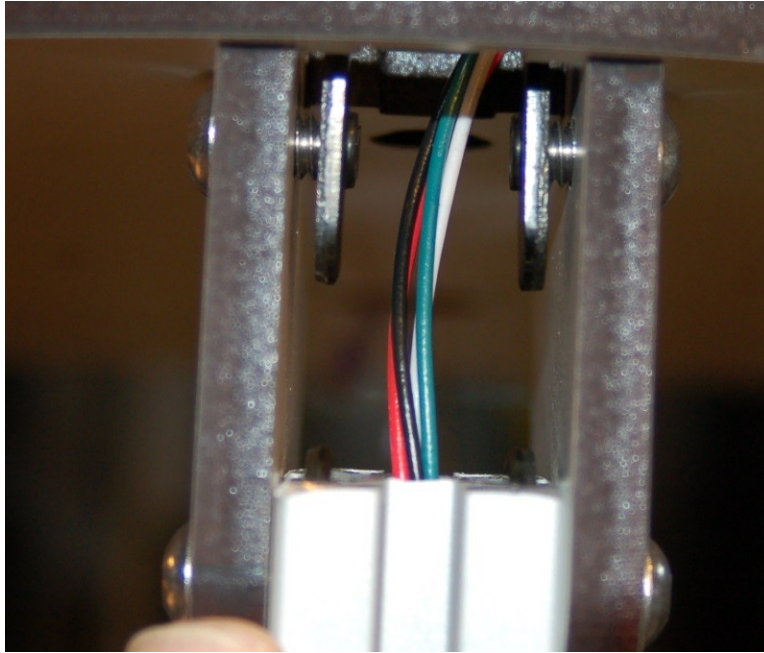

Fig. 7-28: First two t-slot nuts in.

At this point, you should gently tighten the mounting screw on the right. This will hold the mounting plate in the position you see it above. The idea here is to prevent the top from settling too much on one axis until you get the others set to the same depth. If one or more axis settles completely, there will be too much of an angle to allow the other axes to slide onto the towers easily.

Once you've got all three towers started, go back to the Z axis and get the upper set of t-slot nuts started in the tower as shown in Fig. 7-29. Don't forget to loosen the screw you tightened.

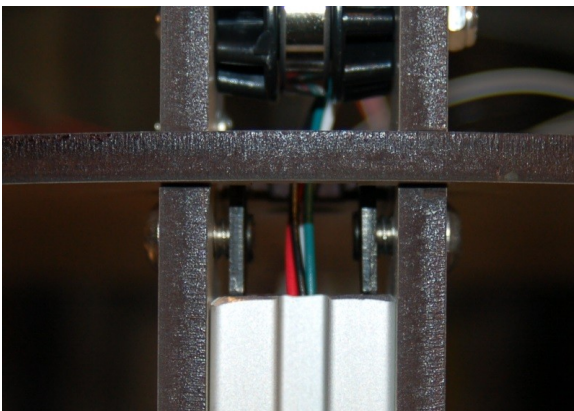

Fig. 7-29: Top set of t-slot nuts inserted.

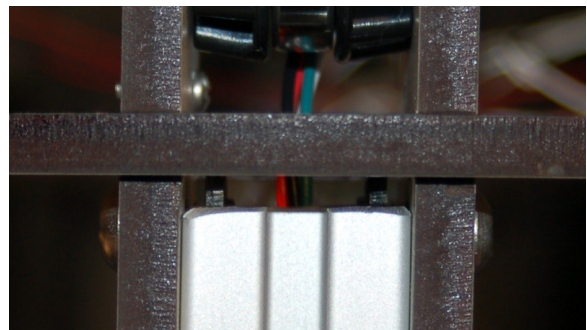

Fig. 7-30: T-Slot nuts fully captured.

Rostock MAX v2 Assembly Guide

Settle each axis down until all three are down as far as they can go – each will be in contact with the small stop screw on the left side of each tower mount.



Fig. 7-31: Fully seated.

Tighten each of the tower's button head cap screws only finger tight. We'll come back and tighten them the rest of the way once the end stops are connected and the other wires are routed & tied down.

Checkpoint Video #9: <http://youtu.be/QrD9aWm9ykU>

Connecting the End Stop Switches

For this task, you'll be routing the end-stop wires to the end-stop switches and connecting them up. At the "front" of each tower there is a small, triangular shaped opening that you're going to pass the end stop switch wires through. We'll start with the Z axis. Pull the leads you labeled "Z" across from the X axis and route them through the hole shown in Fig. 7-32. If you need more wire to reach, gently pull it up at the top of the X tower. You may need to lift the X tower a little bit to lessen the bend radius the wire needs to feed.

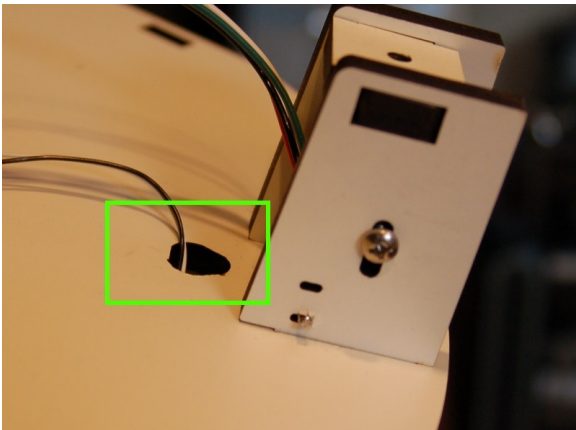

Fig. 7-32: Z axis end stop wire hole.



Fig. 7-33: Z axis wires ready to plug in.

Now carefully seat each spade lug connector on to the end stop switch as shown below. It doesn't matter where the white & black wires go, just as long as one is on the innermost spade lug and the other the outermost.

Repeat this process for the X and Y towers.

Once all three towers are done, **carefully** pull the wires at the bottom of the X tower to pull out the slack in the Z and Y axis end stop wires. Don't pull them too tight – you just want the wires to be fairly straight.



Fig. 7-34: Z axis end stop switch wired.

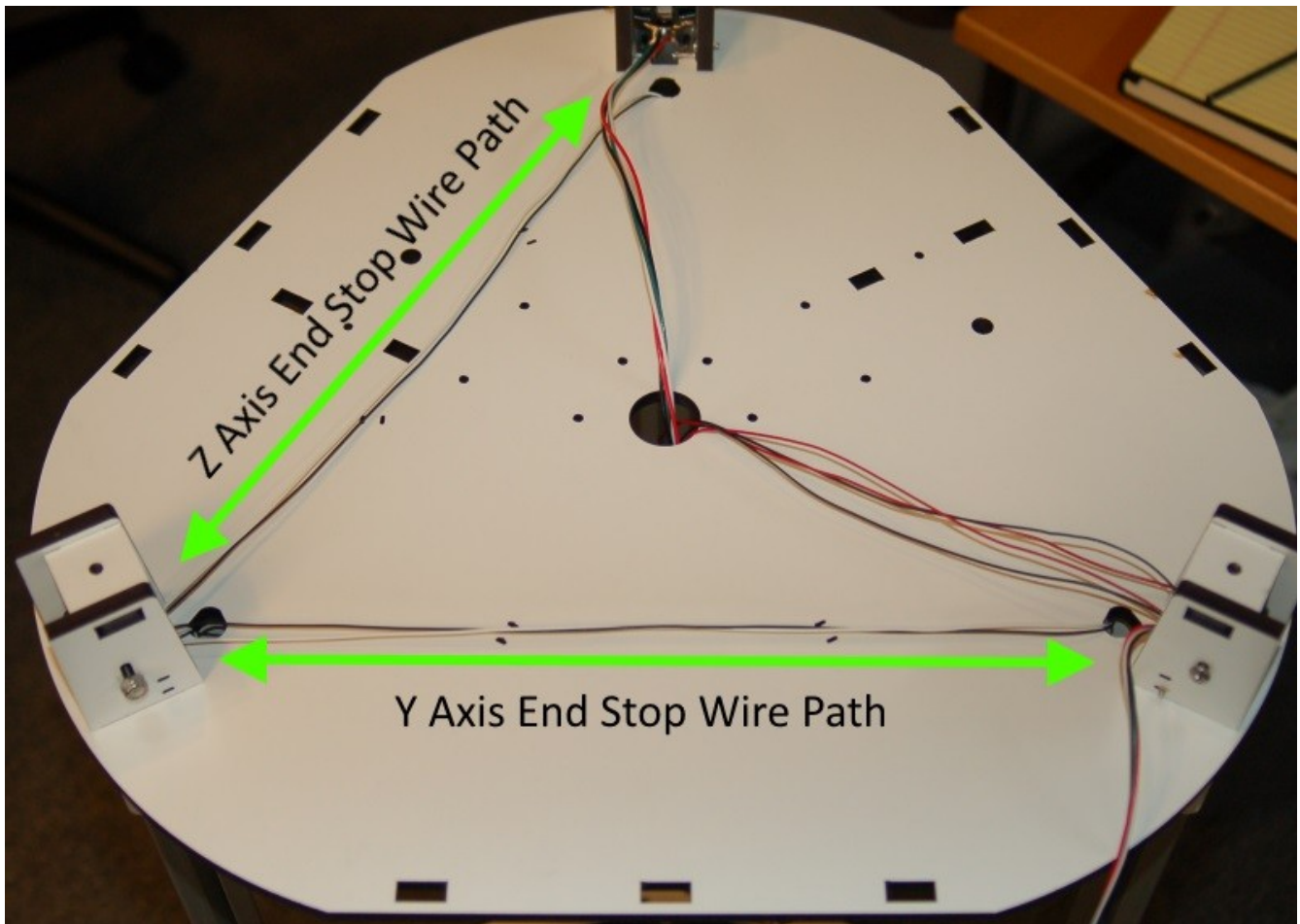

Fig. 7-35: Z and Y axis end stop switch wire paths.

[Top plate is flipped in the photo, but the wire path remains the same!]

The figure above shows the Y and Z end stop switch wire paths. The start point for both is the X axis on the lower left.

Routing the wires & binding them.

For this task, you'll need seven small wire ties.

Let's pull the four 18ga wires from the Z tower and the four 26ga wires from the Y tower through the center hole in the top plate. Carefully feed 30" of wire as measured from the top plate. This will give you plenty of length to work with when it comes time to wire up the hot end.

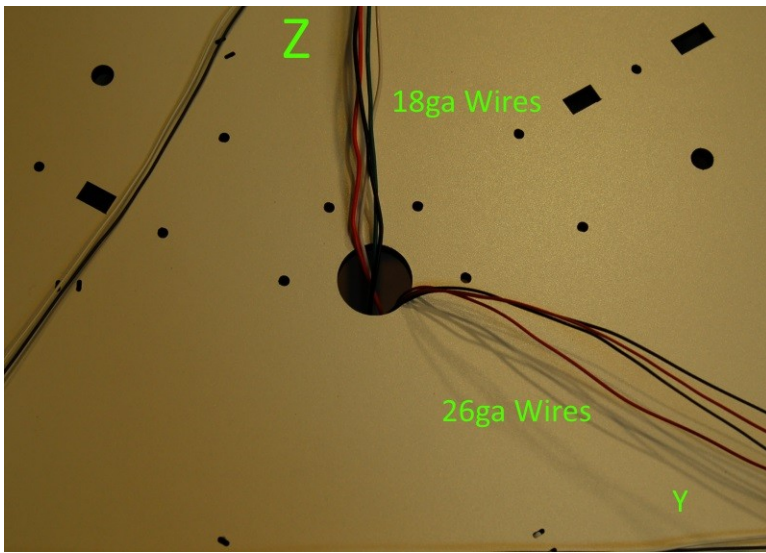

Fig. 7-36: Routing the hot end wires.



Fig. 7-36A: Wires pulled.

Rostock MAX v2 Assembly Guide

Now route the four 22ga extruder motor wires from the Y axis tower till they touch the center hole. That will give you about 8" of wire from where the wires exit the top of the Y tower to the center of the top plate.

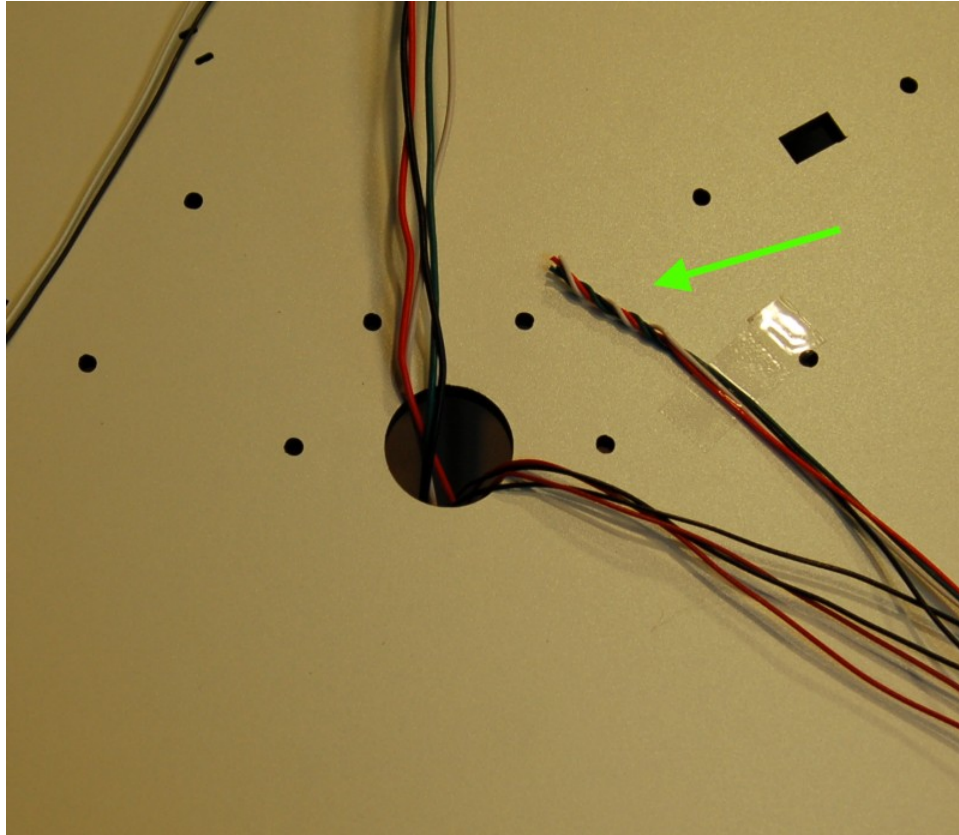

Fig. 7-37: Extruder drive wires.

Use a bit of Scotch tape to hold the wires in place. If you fold over the end of the tape, it'll give you a nice handle to pull on when it's time to remove it.

Rostock MAX v2 Assembly Guide

Now we need to get the wires tied down! The axis tie locations consist of two small laser cut slots in the right side of each upper tower mount. A representative example is shown below in Fig. 7-38. You will want to temporarily remove the idler pulley in order to give yourself more room to work.

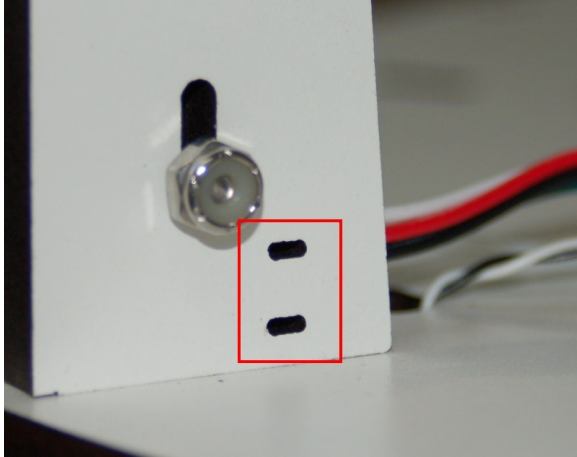

Fig. 7-38: Example tie down point.

Let's start with the X axis. Make sure that the end stop wires exit the top of the tower to the right – when the wires are pulled tight using the wire tie, it will keep them from interfering with the belt path.



Fig. 7-39: Capturing the end stop wires.



Fig. 7-40: End stop wires pulled tight.

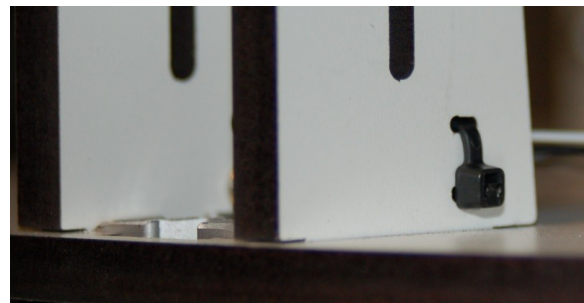

Fig. 7-41: Tail clipped off.

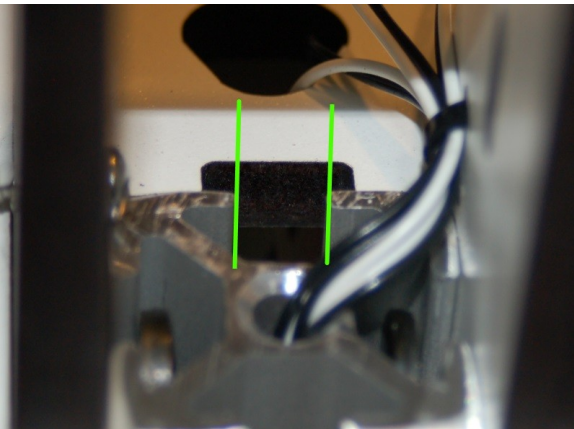

Fig. 7-42: Clear belt path.

When you're done, re-install the idler pulley if you removed it, and we'll move on to tying down the end stop wires between the X and Z towers.

Rostock MAX v2 Assembly Guide

There are two tie down points located in a straight line between the X and Z towers. These two points are used to retain the end stop wires that go from the X to the Z tower.

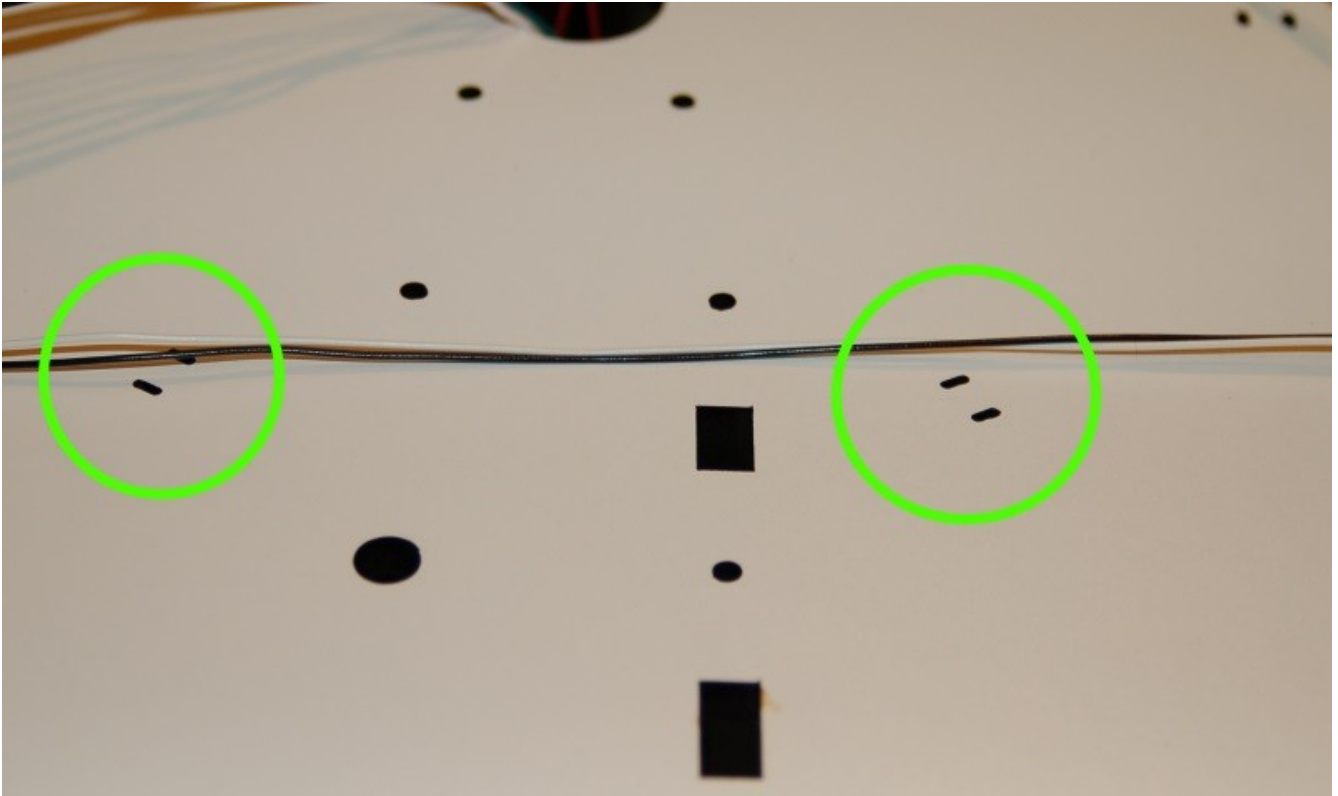

Fig. 7-43: X-Z path tie down points.

Insert a wire tie from below as shown below and pull it tight and clip off the “tail” of the wire tie.

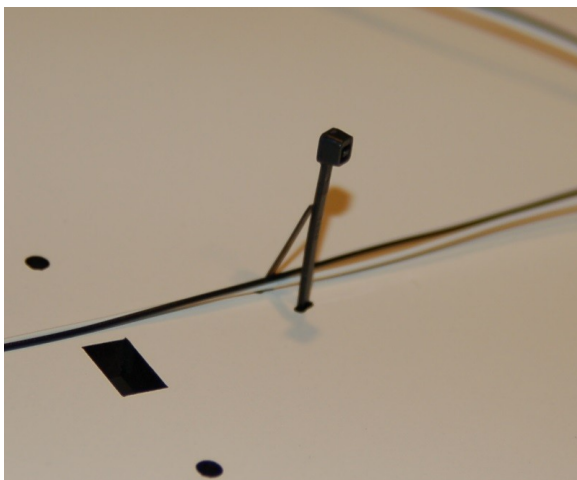

Fig. 7-44: Tie ready to fix in place.

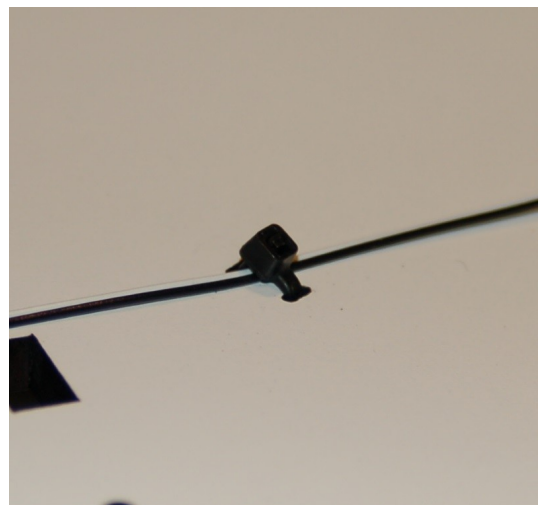

Fig. 7-45: Tightened & clipped.

Rostock MAX v2 Assembly Guide

Install another wire tie in the other location and we'll move on to the Z axis.

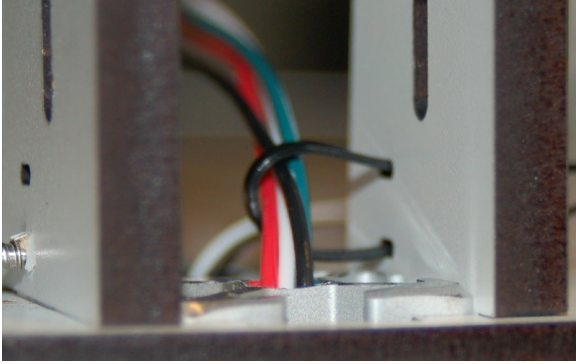

Fig. 7-46: Tying down the hot end wires.

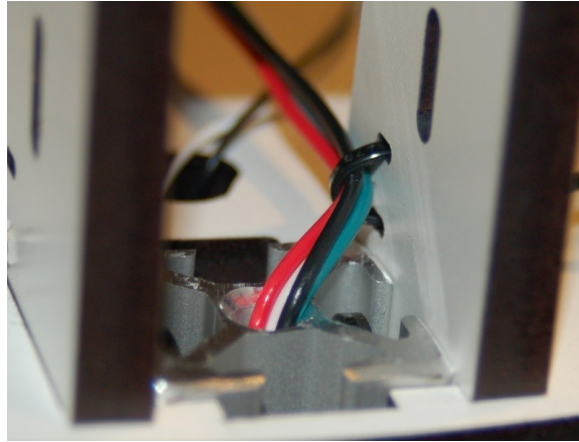

Fig. 7-47: Tied in place.

Once the Z axis wires are tied out, move on to the Y axis and tie those down as well.

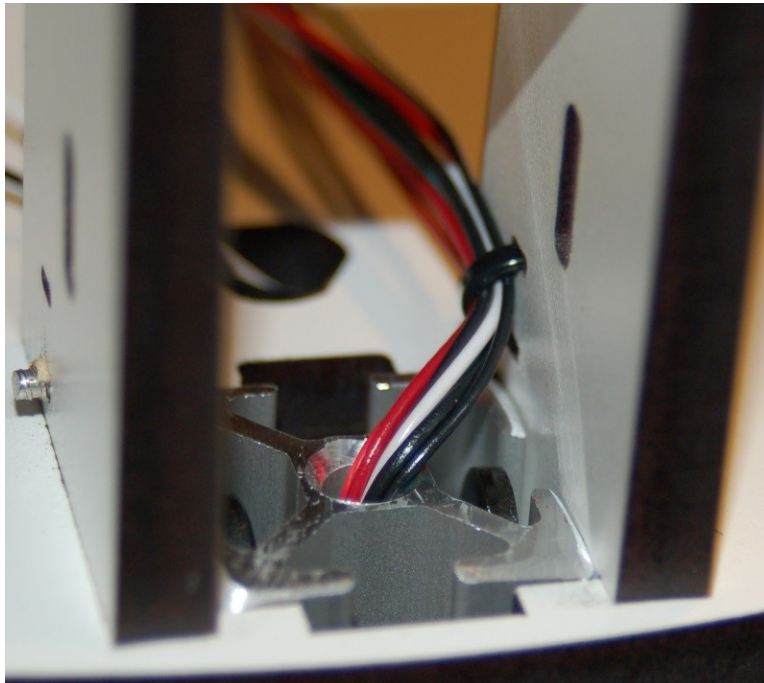

Fig. 7-48: Y axis wiring tied down.

Rostock MAX v2 Assembly Guide

Once the Y axis is done, tie down the end stop wires that run from the X to the Y axis as shown below. The process is the same as what you did for the X – Z end stop wires.

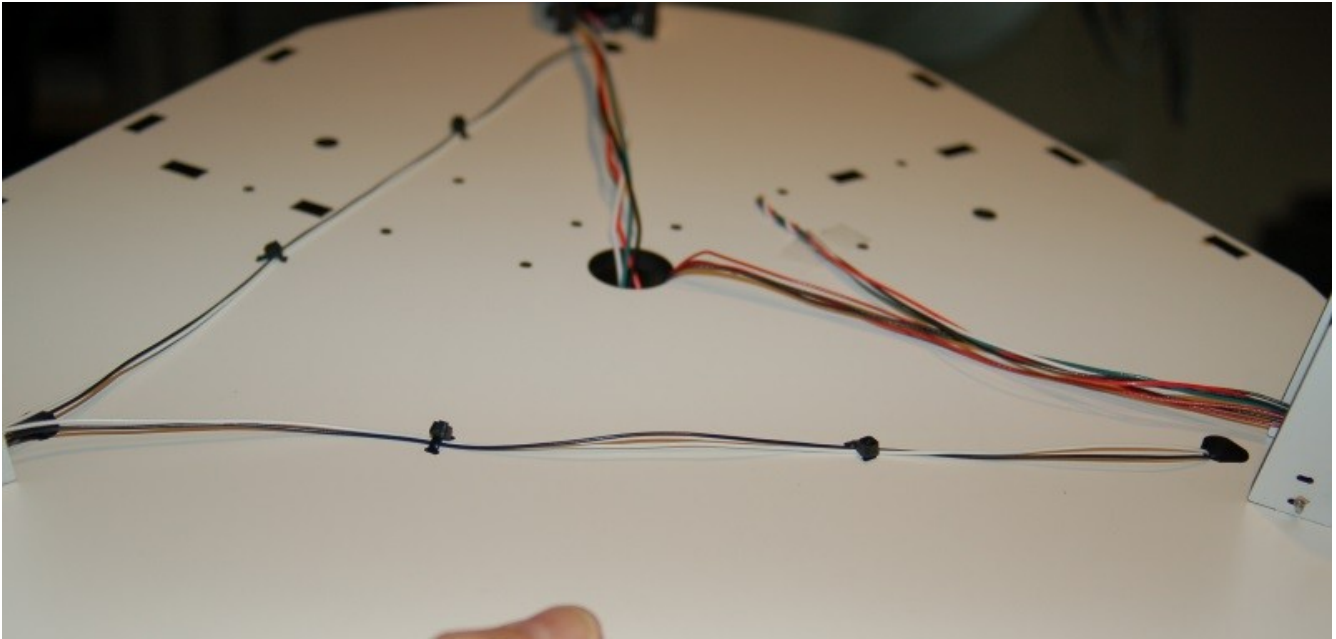

Fig. 7-49: X-Y tie downs.

Checkpoint Video #10: <http://youtu.be/VhYcsn17Ru4>

Tightening the Towers

Part of this process involves making sure that the towers are square to the heated bed. You'll need your small framing square for this task. Before you start, make sure the machine is sitting flat on the table with no wires under the feet, etc.

The first thing to remember about this process is to make sure that the tower is in contact with the depth stop screw BEFORE you begin to tighten down each tower (bottom & top). If you don't, the top of the machine won't be level and that will make calibrating the printer very, very difficult.

Grab your trusty 12" framing square and a clamp and set them up as shown below. I started off with the X axis tower.

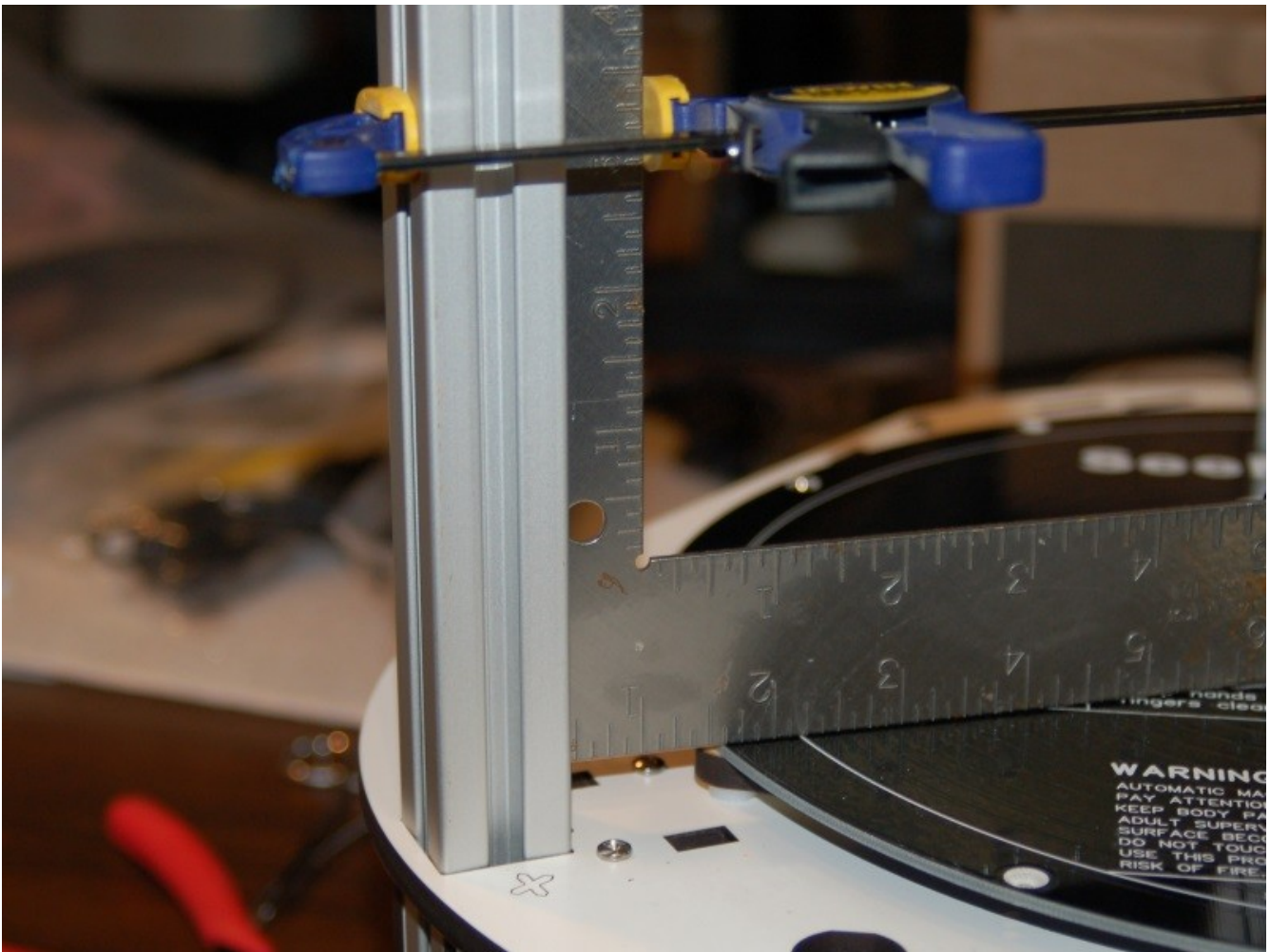

Fig. 7-50: Preparing to square the first tower.

Rostock MAX v2 Assembly Guide

To square the tower, you'll need to push or pull the top of the tower in order to get the long arm of the square to contact the bed all the way across. You'll need to offset the angle of the square a bit to keep it off the Kapton tape in the center. Once you've got it square, tighten the screws using a 5/32" Allen wrench using the pattern shown below.

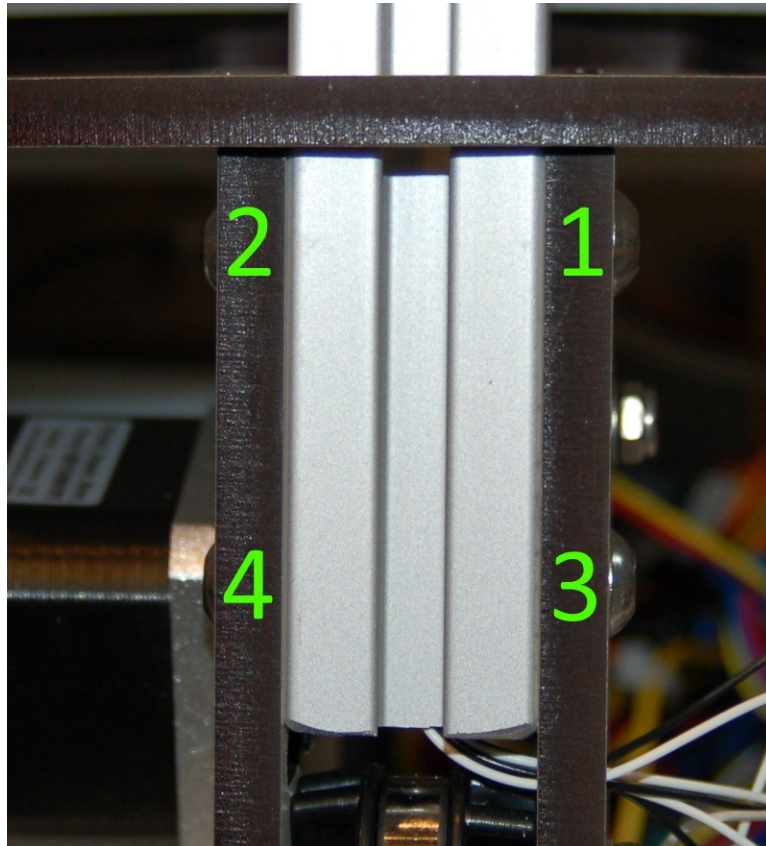

Fig. 7-51: Tightening order.

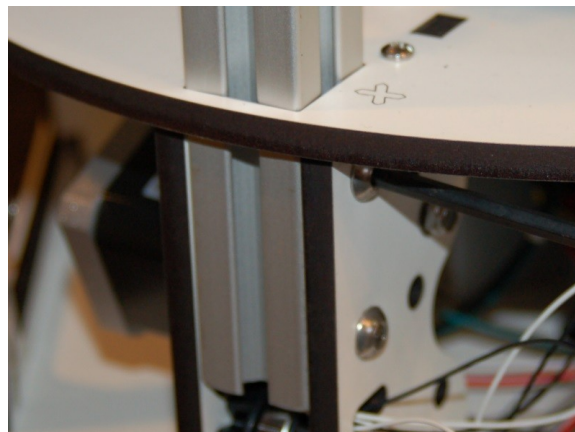

Fig. 7-52: Tightening screw #1.

Rostock MAX v2 Assembly Guide

When you're done with the four screws at the bottom of the tower, move up to the top and tighten those four, using the same order as you did the bottom. *Make sure the top of the tower is in contact with the stop screw!*



Fig. 7-53: Tightening the top, screw #3.

Repeat the square & tighten tasks for the Z and Y towers.

Checkpoint Video #11: <http://youtu.be/HWNhClZoRFU>

8 – Assembling and Installing the Cheapskate Carriages

Assembling the Cheapskate Rollers

For this task, you'll need the following components:

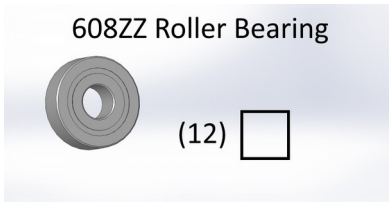

The Cheapskate rollers are made from two bearing sleeves and a single 608ZZ bearing. You'll need to apply sleeves to all 12 bearings used in this step. The tolerances on the sleeves are VERY tight. They may also have a sharp lip on the outer face. You might want to use some of the scrap Melamine to help you press the sleeves on to the bearings without leaving a ring on your palm.



Fig. 8-1: 608ZZ bearing and two sleeve halves.

Start by laying a sleeve half on the table, open face up. Set a 608ZZ bearing into it and firmly press into place. You can use a bit of Melamine scrap as I suggested previously, or the back end of your P2 screwdriver.



Now set the other sleeve half *Fig. 8-2: Pressing the bearing in.*

Rostock MAX v2 Assembly Guide

on the table with the same orientation as before. Lay the bearing into it and press into place.



Fig. 8-3: Ready to press home!



Fig. 8-4: Assembled bearing.

Repeat this process for the remaining 11 608ZZ bearings.



Fig. 8-5: Finished bearing set.

Assembling the U-Joint Carriers

For this task, you'll need the following components:

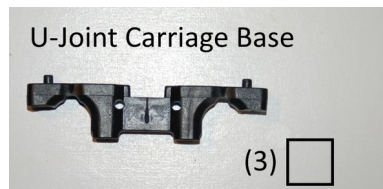
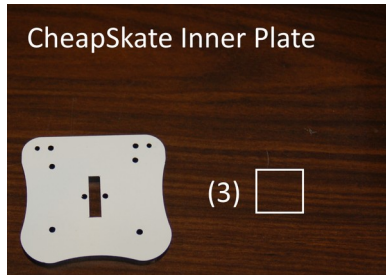
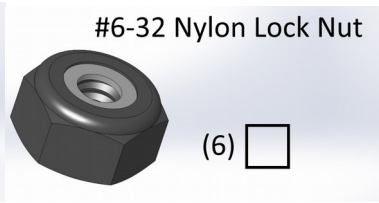
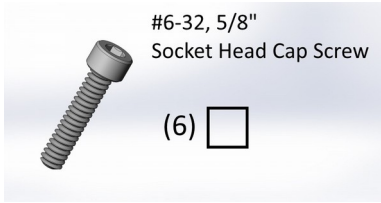

The U-Joint carriage base gets installed on the inside carriage plate by pressing their alignment pins into the holes indicated by the arrows in Fig. 8-6.



Fig. 8-6: U-Joint carriage installation location.

IMPORTANT! Note the orientation of the inner plate above. The pair of holes on the left are closer together than the pair on the right. You must retain this orientation otherwise the CheapSkate outer plate won't fit in it's correct orientation (eyes "looking" right) when it's time to assemble the Cheapskates!

Rostock MAX v2 Assembly Guide

Note that these u-joint carriers are an interim design and are simply the original v1 parts that have had the end posts ground off. You may find that the grinding has removed enough material that the alignment pin is no longer able to remain in place. If you find that happening, just remove that alignment pin and hold it in place until you can get the socket head cap screws installed.



Fig. 8-7: U-Joint carriage fitted properly.

From the front side of the U-Joint carriage, insert two #6-32, 5/8" socket head cap screws through the holes indicated. Install two #6-32 Nylon lock nuts on the back and tighten them down using a 7/64" hex wrench and a 5/16" wrench.



Fig. 8-8: SHCS inserted...



Fig. 8-9: Nylon lock nut installed.

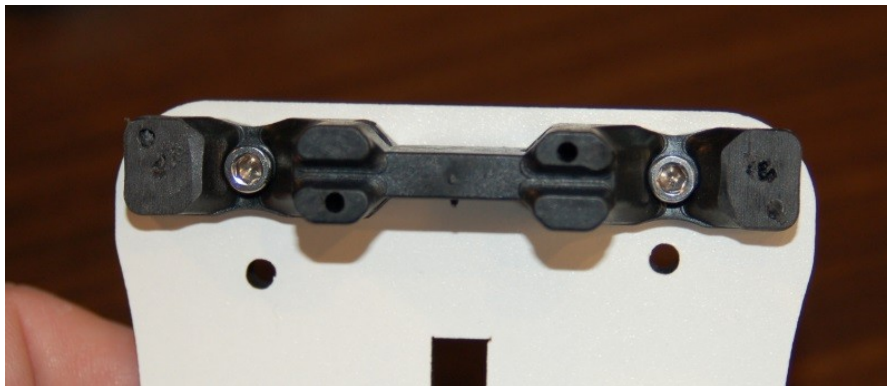

Fig. 8-10: Both SHCS installed.

Rostock MAX v2 Assembly Guide

Next, you'll need to install a #6-32, 1/2" Stainless Steel flat head screw. This screw is what triggers the end-stops when the printer is commanded to its "home" position.

Install the screw *exactly* as shown in Fig. 8-11. Use the rightmost hole in the u-joint carrier – this hole lines up with where you installed the end-stop switch. When you install the screw, try to leave the bottom of the head even with the top of the inside carriage plate as indicated by the green line in the photo. This will give you a consistent start point when it comes time to calibrate the printer when your build is completed. Make sure you install each screw the same way on all three Cheapskates. This will help give you a consistent starting point when you being calibrating your Rostock MAX v2.

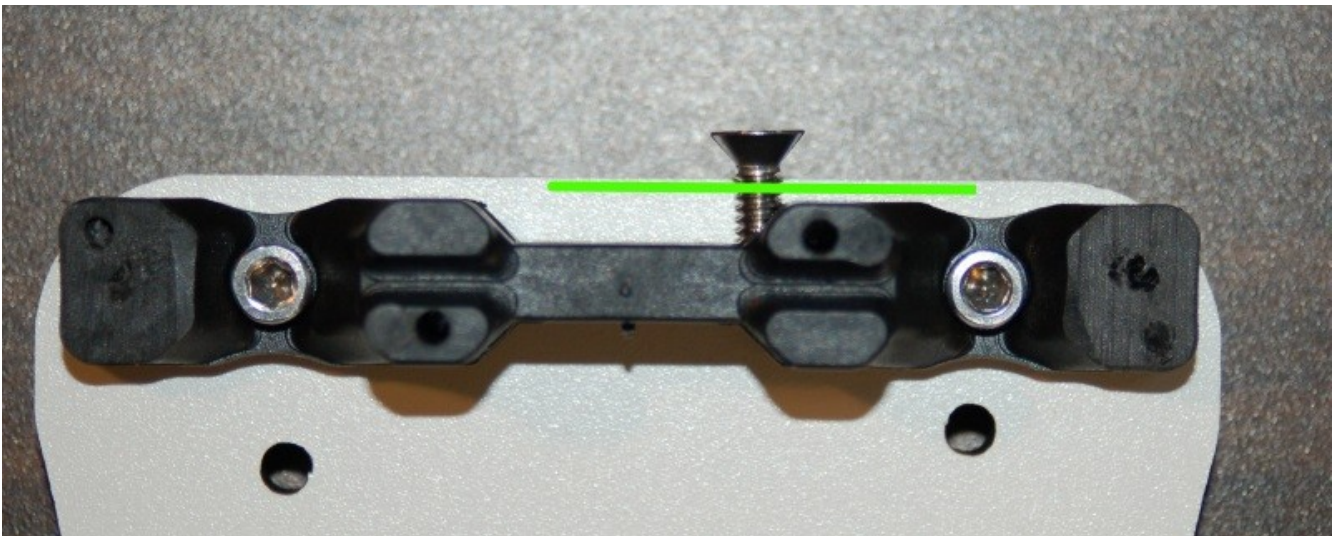

Fig. 8-11: Proper initial screw depth.

Repeat these steps for the two remaining Cheapskates.

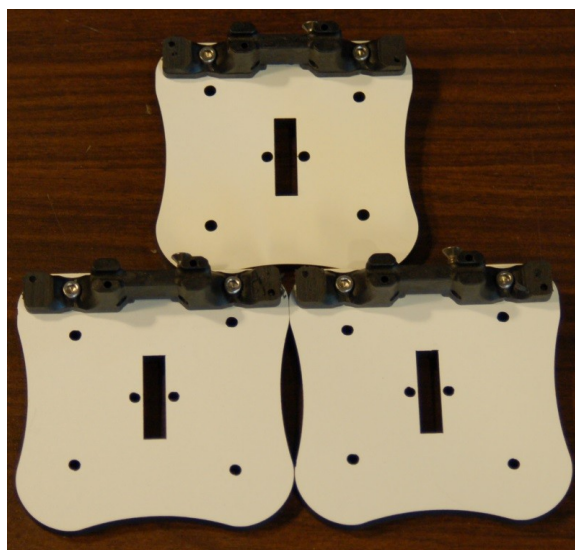
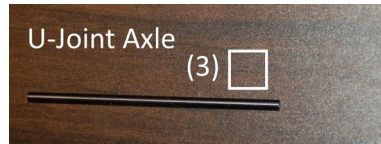

Fig. 8-12: U-Joint carriages installed.

Installing the U-Joint Axles

For this task, you'll need the following components:



Carefully inspect the u-joint axles. Ensure that they're perfectly straight and are free of any scarring. If the axle is bent or badly scarred, contact support@seemecnc.com for a replacement.

The U-Joint carriage has a shallow slot to hold the u-joint axle. Press the axle into the slot. Make sure that the axle is perfectly centered on the u-joint carriage!



Fig. 8-13: Axle pressed into position.

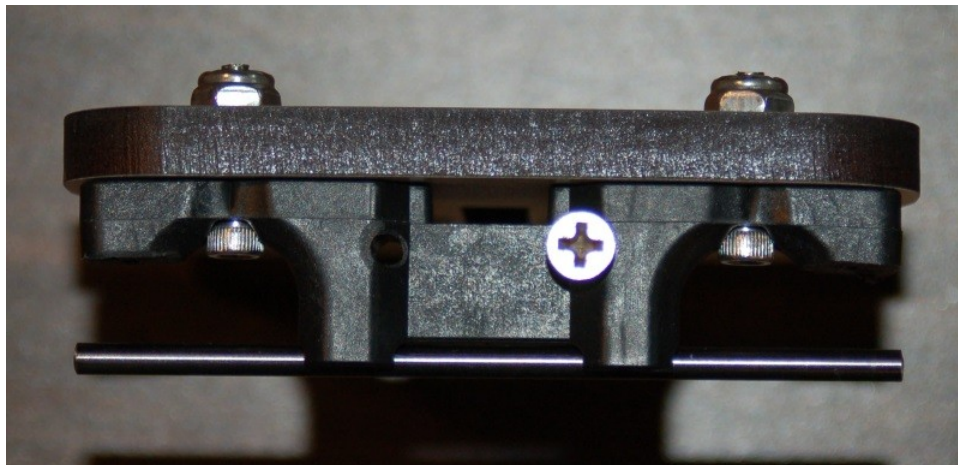

Fig. 8-14: A properly centered axle.

Rostock MAX v2 Assembly Guide

Now take two #4, 3/8" sheet metal screws and install them into the locations shown to hold the axle in place.



Fig. 8-15: Axle retaining screws installed.

When fully tightened, the #4 screws should be in full contact with the u-joint carrier and should slightly overlap the axle as shown above.

Repeat this task for all three u-joint carriages.

Installing the Belt Clip T-Nuts

For this task you'll need the following components:

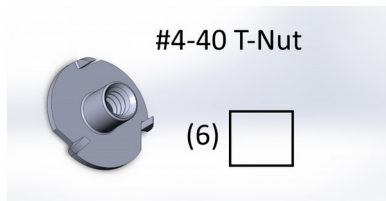

Install two #4-40 T-Nuts in the back of all three Cheapskate inner carriage plates as shown.

Make sure the barbs on the t-nuts are fully seated in to the Melamine. A good tap with a hammer should fully set them. Cover each one with a bit of Scotch tape to hold them in place.

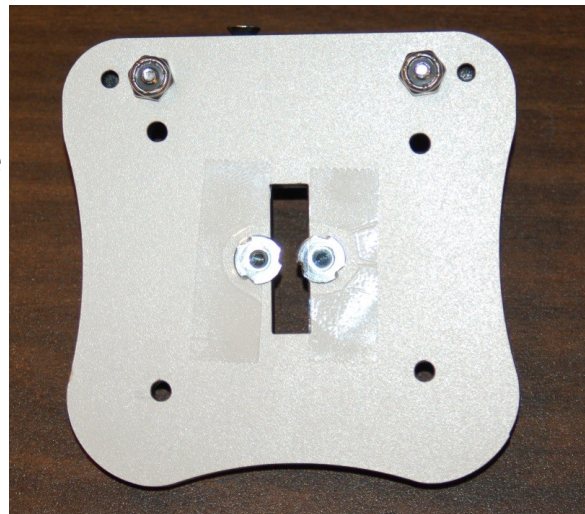
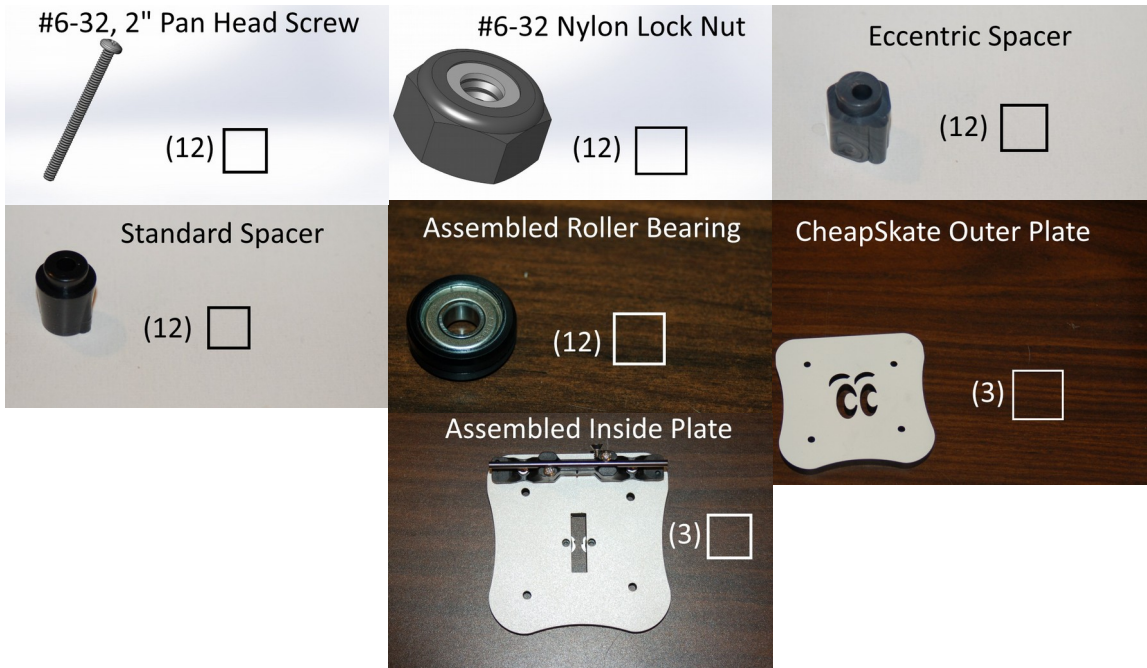

Fig. 8-16: T-Nuts installed.

Assembling and Installing the Cheapskate Carriages

For this task, you'll need the following components:



Each Cheapskate will get two roller bearings with “Standard” plastic spacers and two roller bearings with “Eccentric” spacers. The eccentric spacers are used to correctly adjust the “grip” that the roller bearings have on the towers.



Fig. 8-17: Standard spacers.

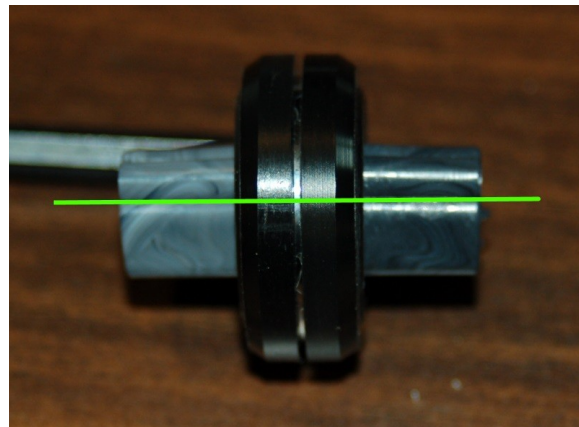

Fig. 8-18: Eccentric spacers.

The eccentric spacers have a small “bulge” on one face. When inserting the spacers into the roller bearing, make sure the bulges are lined up with one another as shown above in Fig. 8-18.

Rostock MAX v2 Assembly Guide

Start assembling the first Cheapskate by inserting four #6-32, 2" pan head screws into the outer plate as shown below. Make sure you keep the same orientation in the photo – you want the eyes “looking” to the left.



Fig. 8-19: Outer plate ready for bearings.

Now install the roller bearings equipped with the eccentric spacers.

Now slide on two roller bearings equipped with the standard spacers as shown below.

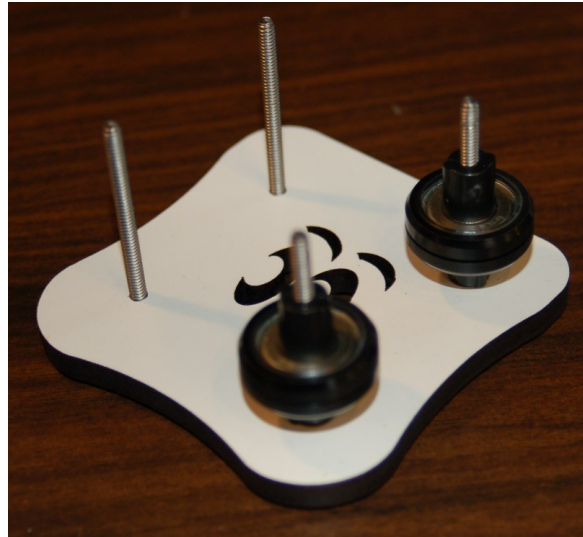

Fig. 8-20: Standard bearings added.

You'll note that the bulges on the two eccentrics are aligned. This is very important! If they're not lined up, you'll have problems getting the Cheapskates adjusted properly.



Fig. 8-21: Eccentric bearings installed.

Rostock MAX v2 Assembly Guide

Now install the Cheapskate on to the X tower as shown below.

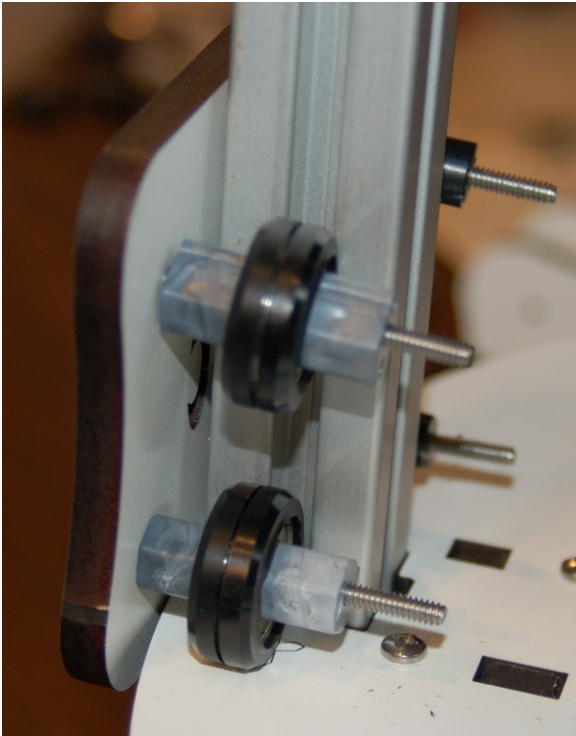

Fig. 8-22: Cheapskate resting on the X tower.

Fix the outer plate into place with four #6-32 nylon lock nuts as shown below. Fully tighten each one.

Note that I've oriented the bulges on the eccentrics so that they point up. This gives you a good starting point when it comes time to adjust them.

Now you can slide the inner plate on to the four screws as shown.

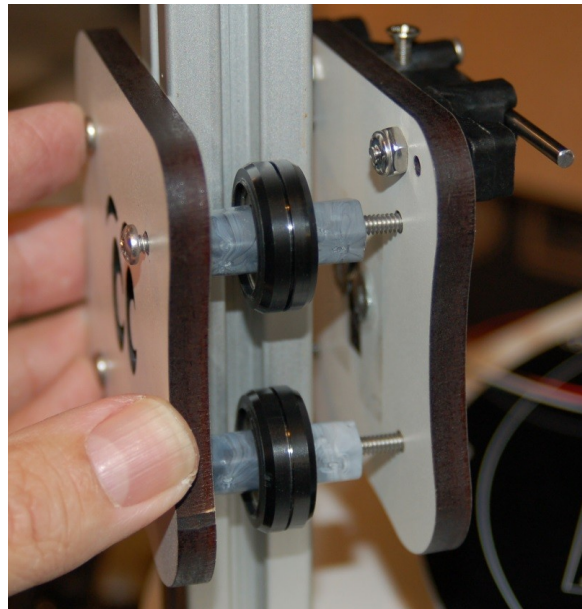

Fig. 8-23: Inner plate installation.



Fig. 8-24: Inner plate attached.

Repeat this process for the Y and Z towers and then we'll move on to adjusting the proper "grip" for each Cheapskate.

Adjusting the Cheapskate Carriages

Once you've gotten all three carriages installed, you'll need to adjust the eccentric spacers in order to tighten the grip of the roller bearings on the aluminum tower.

You'll need two 7/16" wrenches in order to make sure that you're adjusting both eccentric spacers at the same time.

You want to tighten the upper and lower rollers such that it grips the tower with no horizontal or vertical rotation – it must roll straight up and down.

I've created a short YouTube video that shows the degree of tightness that you're after with your adjustments.

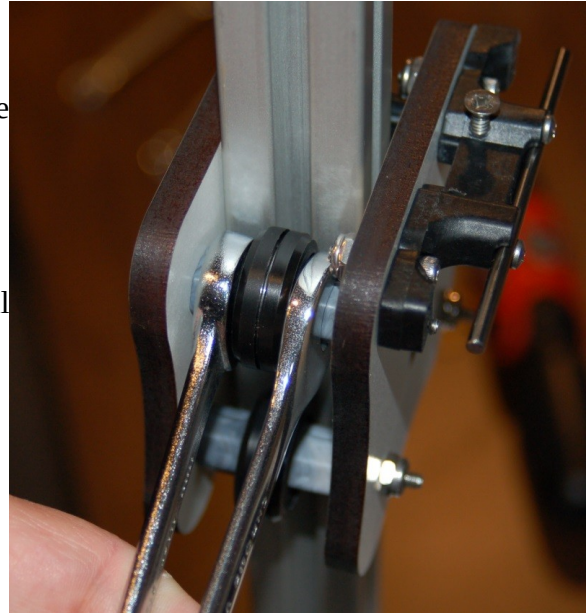

Fig. 8-25: Adjusting the upper eccentric.

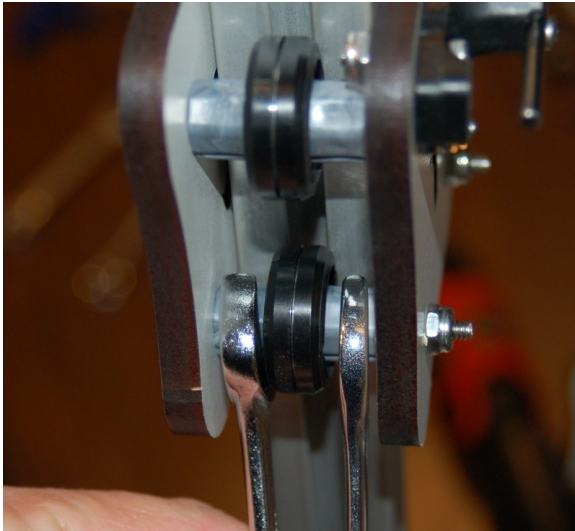

Fig. 8-26: Adjusting the lower eccentric.

Adjust all three Cheapskate carriages so that they're all at as close to the same "grip" as you can get it. A good way to estimate that is to make sure that the little bulges on the eccentric spacers match across all three Cheapskates. Get one set as good as you can and then make the position of the others match. If it doesn't get you dead-on, it won't take much adjustment after that point.

The checkpoint video below illustrates how a properly adjusted Cheapskate should move.

Checkpoint Video #12: <http://youtu.be/3nzUM2d05qQ>

You can do a drop test to help ensure that you've got all three Cheapskates tensioned similarly. Hold two up at the top and release them. Move your hands quickly to the bottom to prevent the Cheapskates from striking the bottom. Both Cheapskates should strike your hands simultaneously. Loosen the slower one to match the faster. Do X & Y first and then Y and Z.

9 – Installing the Drive Belts

For this task, you're going to need the following components:

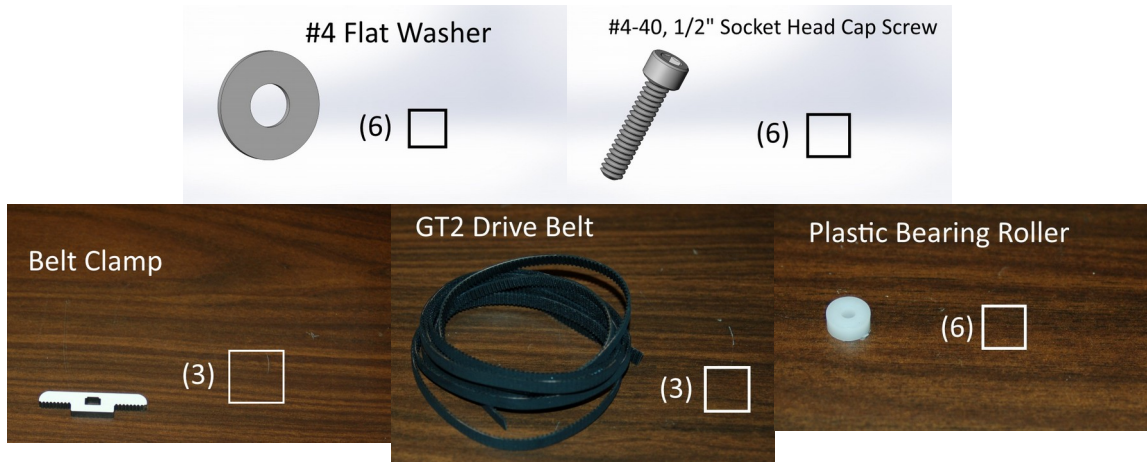

Installing the drive belts on the Rostock MAX v2 is a *lot* easier than it was on the Rostock MAX v1 kit. As you can see from the parts list required, the same job is done with fewer parts making for a much simpler installation. **Tip – if you lay the machine down, it's easier to route & install the belts!**

Belt Routing

Take one of the GT2 drive belts and thread it into the notch at the base of the Z tower as shown in Fig. 9-1. The belt shown below is slightly twisted, but please make sure that the belt teeth face **in** towards the tower.

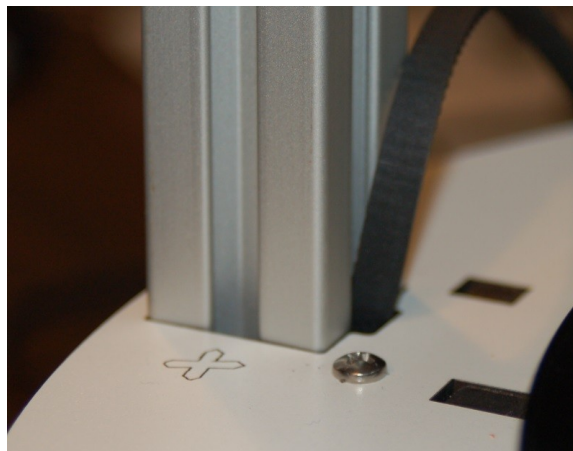

Fig. 9-1: Starting to route the belt.

Rostock MAX v2 Assembly Guide

Next, I want you to feed the belt down and under the upper idler and around the top of the GT2 drive gear as shown in Fig. 9-2.

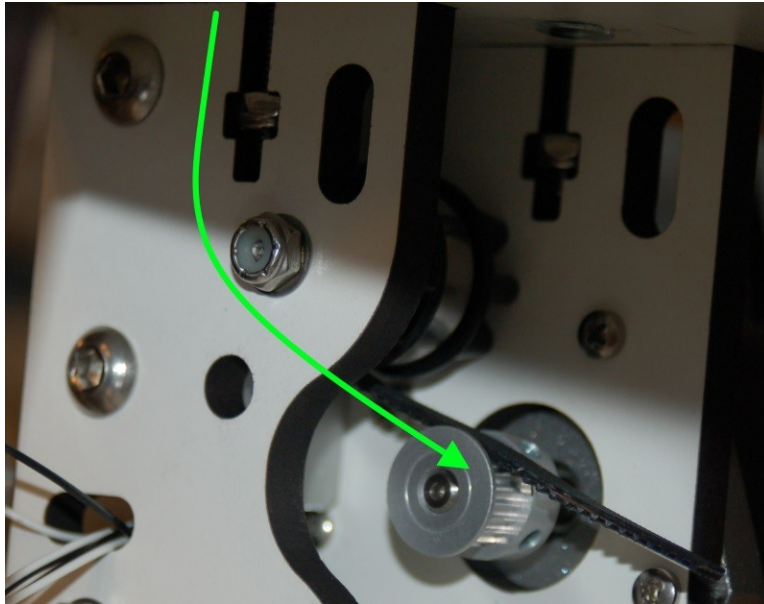

Fig. 9-2: Passing under the idler and over the gear.

Pass the belt around the gear and under the lower idler as shown below.

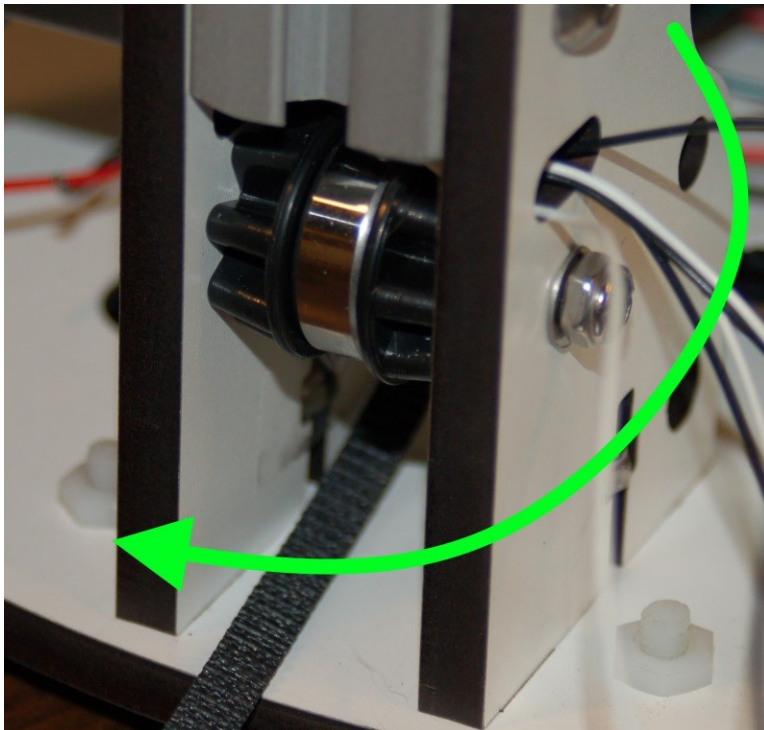

Fig. 9-3: Around the gear and under the idler...to Grandmother's house we go...

Rostock MAX v2 Assembly Guide

Now thread the belt through tower hole in the base plate.

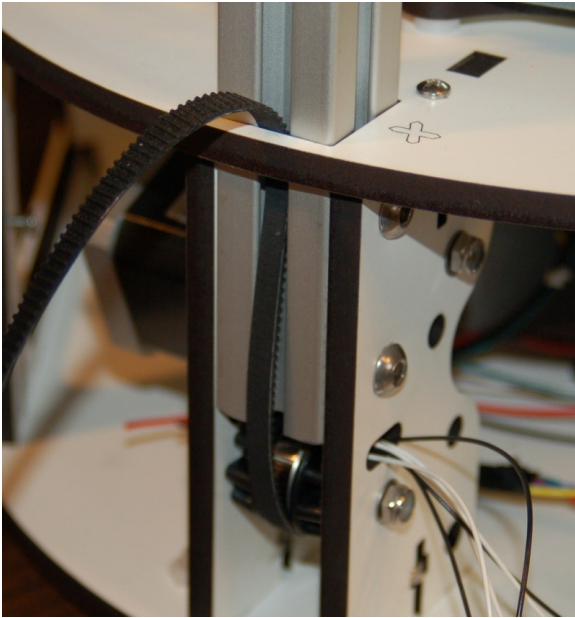

Fig. 9-4: On our way to the top...

Next, thread the belt between the outer face of the Cheapskate and the tower as shown below.

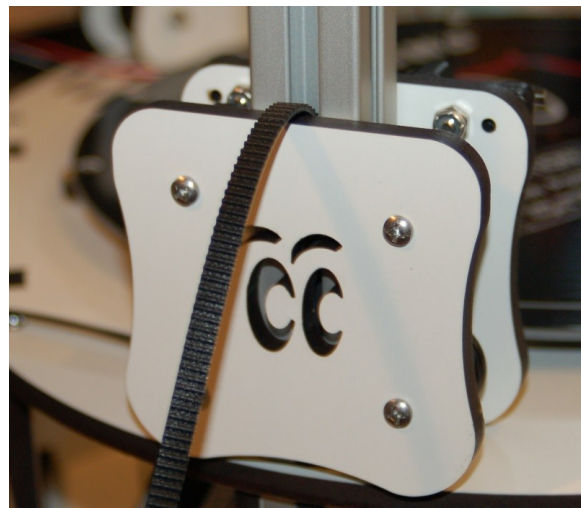

Fig. 9-5: Belt under the Cheapskate.

Now you can pull the belt up towards the top and route it between the tower and the top plate opening as shown.

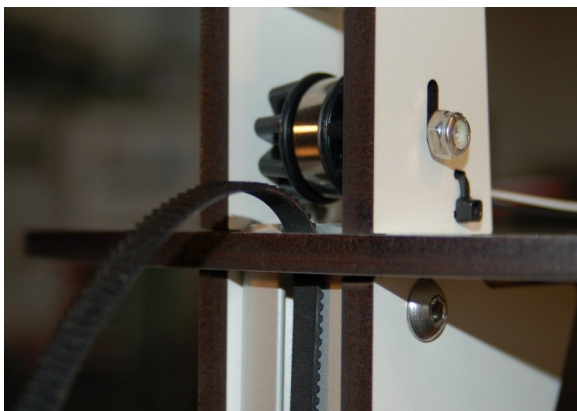

Fig. 9-6: Belt at the top...

Now route the belt over the top of the idler and back down through the tower opening as shown.

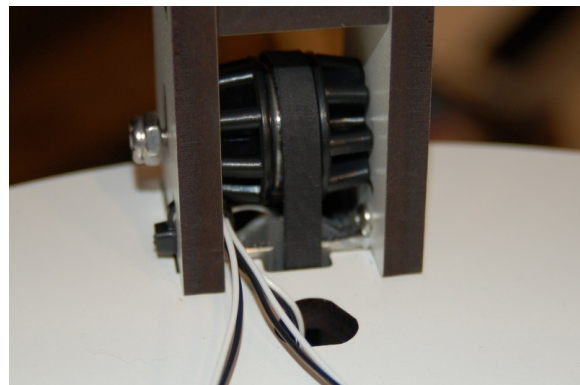

Fig. 9-7: On the way back down!

Rostock MAX v2 Assembly Guide

Pull enough belt through so the belt end touches the top of the Onyx.



Fig. 9-8: Ready to thread into the Cheapskate.

Now you can thread the belt into the Cheapskate. Slide the belt down behind the inner face of the Cheapskate so you can see the end of the belt through the belt guide in the Cheapskate. Using a pair of needle nosed pliers or forceps, grab the belt tip and pull it through. You can slide the belt end up behind the U-Joint carriage to keep it out of the way while you feed the other end of the belt up from the bottom. At this point, inspect the belt path to ensure that the belt is not rubbing against any of the wiring. Install the belts for the Y and Z towers at this time. You may want to tape the ends in place until you're ready to install the belt clamps.



Fig. 9-9: Ready for the belt clamp.

Installing the Belt Clamps

Installing the belt clamps is a pretty straightforward task. If you haven't already, lay the machine down on the side you're going to be working on. It makes installing the clip & clip hardware a LOT easier. Start with the X axis.

Hold the upper end of the belt in place (it'll be on your left with the machine laid horizontal). Now pull the lower end of the belt a bit so that it eats up any available slack and starts to draw the upper belt end out of the Cheapskate. You want about 1" of belt above the left or "top" edge of the Cheapskate. Take a laser cut belt clamp and install it into the notch, capturing only the "top" end of the belt. Holding that end of the clamp in place, pull the bottom end of the belt tight and then press the belt clip in place. **You want to pull the belt tight enough that little if any tension adjustment will be required at the top idler pulley.** If you're not feeling especially dexterous today, tape the ends of the belt clamp in place tightly enough for it to keep a hold on the belt ends. (I have an invisible cat that's very handy, so you won't see me using tape. I just ask her nice, and she holds down whatever I need held down.)



Fig. 9-10: Belt clip in place. Invisible cat not to scale.

(Don't see any cat paws do you? Told ya, invisible cat.)

Make sure that the clamp teeth are fitted into the "low" parts of the belt teeth as shown above.

Rostock MAX v2 Assembly Guide

Take a plastic roller bearing and a #4 flat washer and set them into place in the exposed notch on the belt clamp.

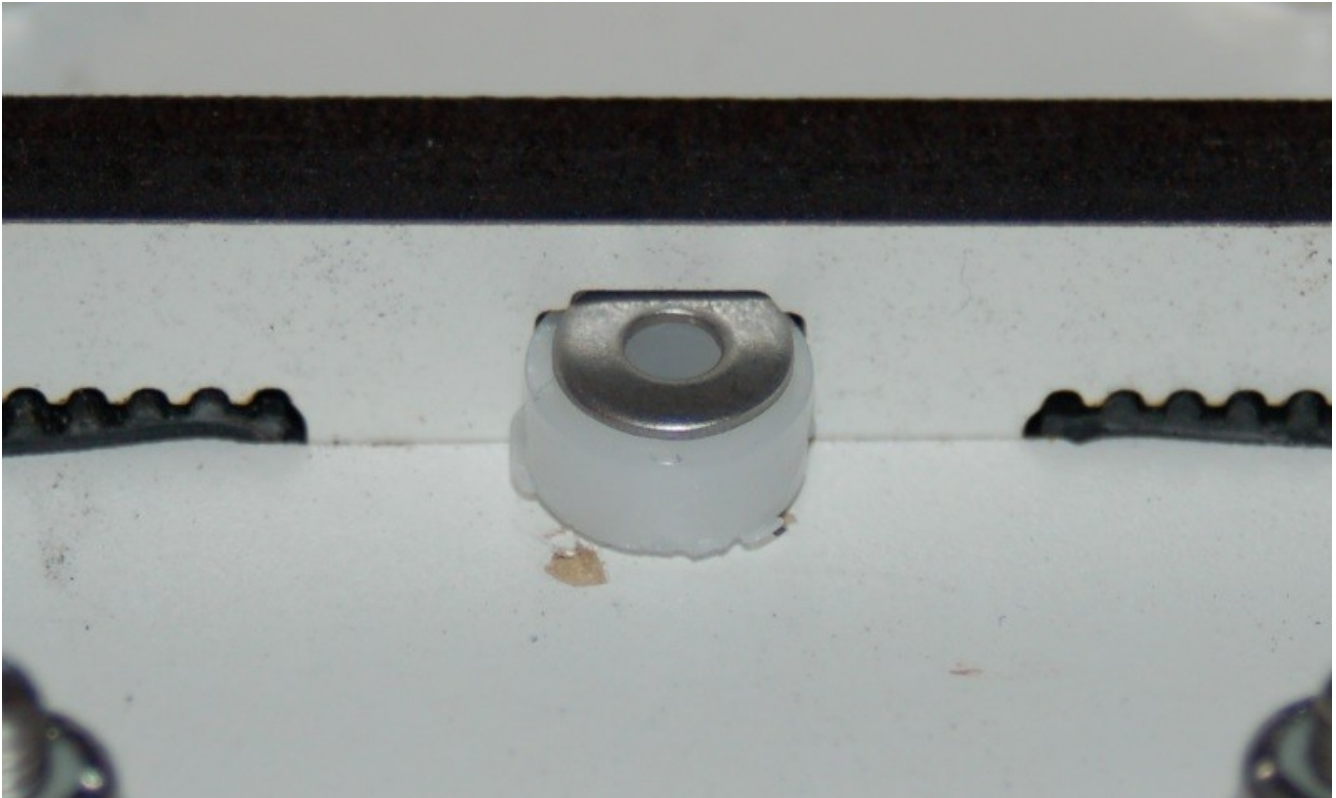

Fig. 9-11: Plastic roller bearing and #4 washer in place.

Now insert a #4-40, 1/2" socket head cap screw through the washer & plastic bearing and then tighten with a 3/32" Allen wrench.



Fig. 9-12: Screw installed.

Install the other plastic bearing, washer & screw on the opposite side as shown to the right.



Fig. 9-13: Belt clamp locked in place.

Rostock MAX v2 Assembly Guide

Repeat this task for the Y and Z axes. **Make sure that while you're working with the belts that the lower belt doesn't slip off the GT2 drive gear! You're better off catching and correcting it now than having to take things apart to fix it later!**

When you're done installing all three belts, trim the “bottom” belt end to about 1” outside the clamp. This will give you enough to grab if you chose to tweak the belt tension at that point instead of on the top idlers.

Adjusting the Belt Tension

The mounting for the top idler pulleys is designed to allow you to increase the tension on the belts if necessary. Setting proper belt tension is more magic than science at this point, but the following instructions will get you at a pretty good default tension.

Insert a P1 screwdriver diagonally through the tower, under the idler bearing as shown below. You want it positioned such that when you lift up on the handle, it will press against the bearing from below and lift it.

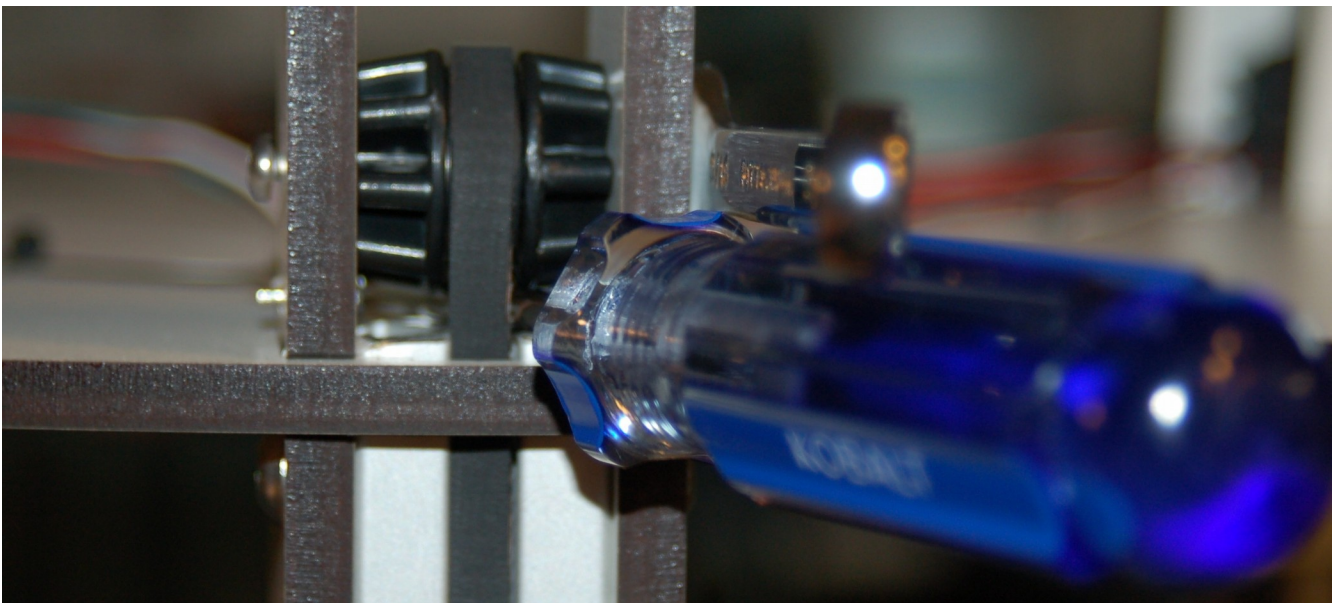

Fig. 9-14: Screwdriver position.

Rostock MAX v2 Assembly Guide

Next, you'll want to set a 5/16" open end wrench on to the idler pulley mount nut as shown. This position will allow you to lift the idler and hold the wrench at the same time.



Fig. 9-15: Wrench in place.

Now hold both the screwdriver and the wrench in your right hand as shown below.



Fig. 9-16: Holding the screwdriver & wrench in place.

Rostock MAX v2 Assembly Guide

Now you can lift up a little bit on the screwdriver and tighten the screw using a power screwdriver.

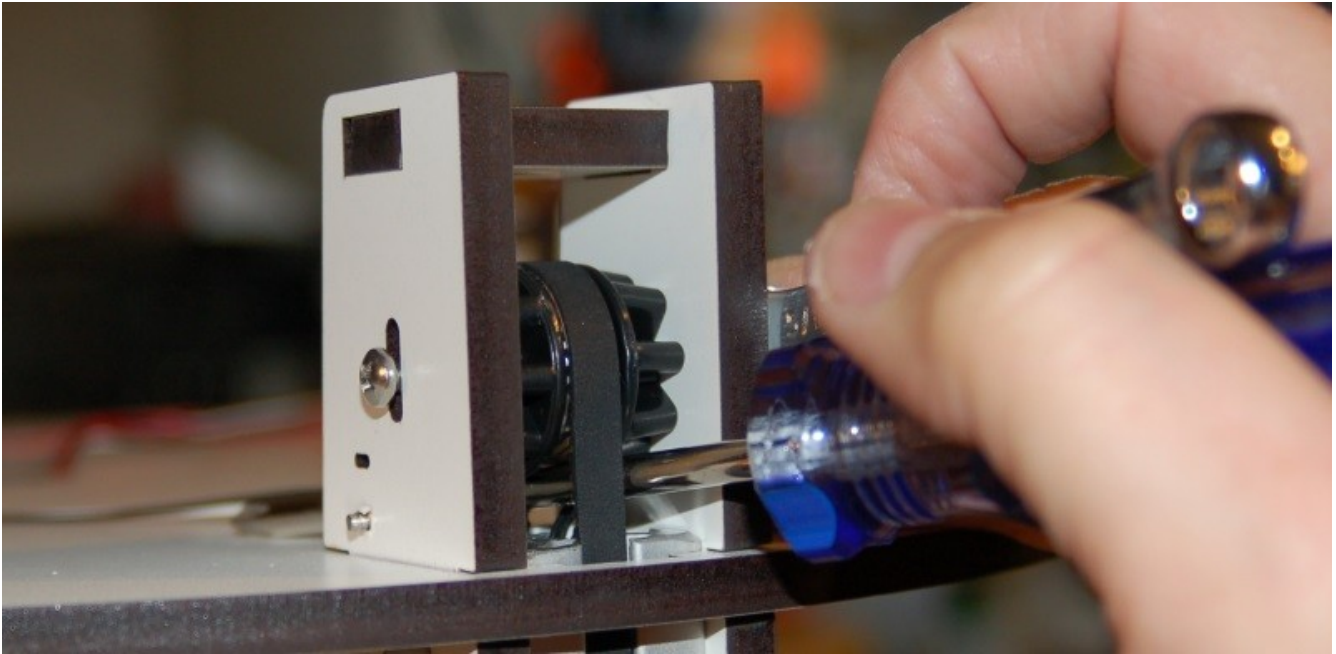

Fig. 9-17: Proper tension position.

If you lift the idler up so that the screw head is in the same location as shown above when you tighten it, you should have pretty good, but not too much belt tension. **DO NOT OVER-TIGHTEN THE SCREW! IT WILL PULL THROUGH THE MELAMINE AND WILL NO LONGER HOLD THE IDLER IN PLACE!**

Also, do **NOT** pull down on the screwdriver to lift up the idler. The Melamine section that you'd be pressing against will split and break if you apply any force to it!

Checkpoint Video #13: <http://youtu.be/Mfvx3JvjzBM>

10 – Assembling and Installing the EZStruder

Before the EZStruder can be installed, you'll first need to assemble it.

Assembling the EZStruder

In order to complete this task, you'll need the EZStruder hardware kit. This kit consists of the following components:

1. (___) Filament Tensioner
2. (___) Filament Guide Block
3. (___) Stepper Motor Mounting Screws
4. (___) Std. Mounting Hardware (Unused)
5. (___) Hobbed Gear & Allen Wrench

You'll also need the remaining NEMA17 stepper motor:

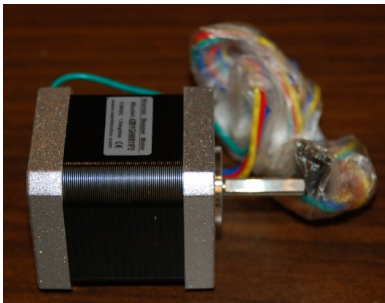

Fig. 10-1: EZStruder Hardware Pack.

Rostock MAX v2 Assembly Guide

The filament tensioner includes two mounting screws that are “captured” inside the assembly.



Fig. 10-2: Filament tensioner.

Rotate the stepper motor so that the wires are facing up and then set the filament tensioner against the face of the stepper motor and tighten the two screws.

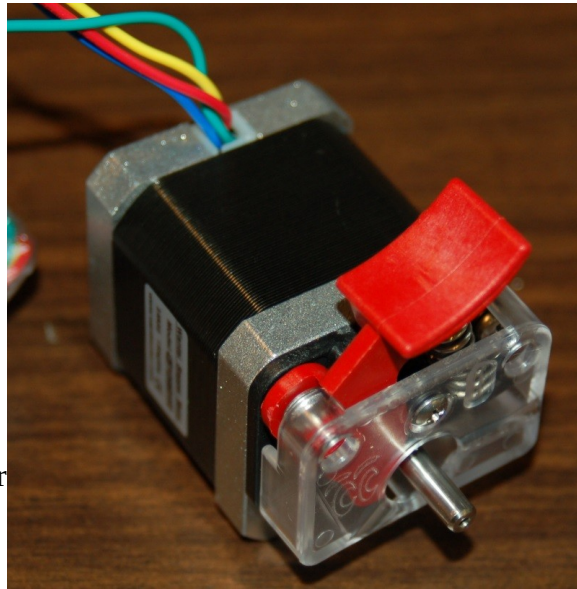

Fig. 10-3: Filament tensioner installed.

The next task will be to install the hobbed gear. Before you can do that, you'll need to turn the output shaft of the stepper motor so that the flattened portion of the shaft is facing the opening in the side of the filament tensioner as shown in Fig. 10-4.

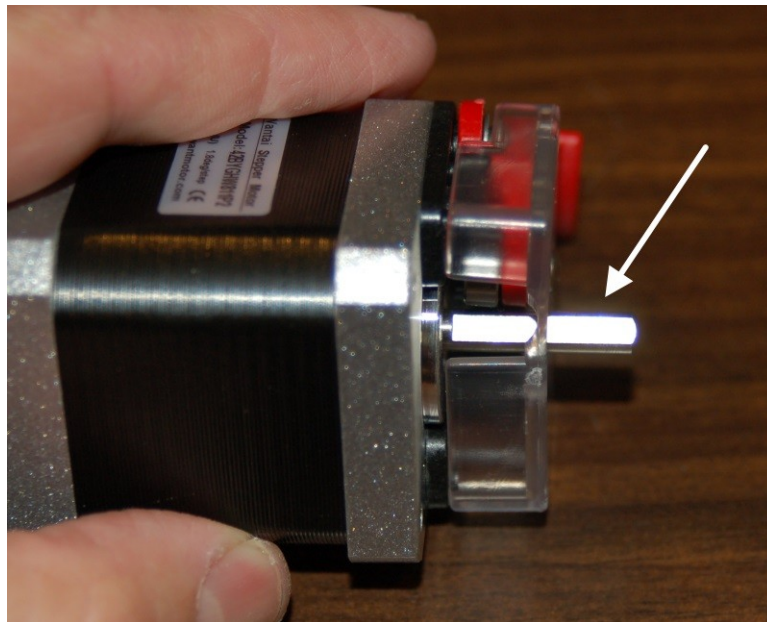

Fig. 10-4: Shaft aligned.

Rostock MAX v2 Assembly Guide

Remove the grub screw from the hobbled gear and set it aside.

Press your thumb against the red lever on the filament tensioner and slide the hobbled gear on to the shaft with the hobbled portion closest to the face of the stepper motor.

You want to align the hobbled portion of the gear with the steel bearing on the filament tensioner as shown in Fig. 10-5. The idea is to get the center line of that little bearing lined up with the center line of the hobbled portion of the gear. Guessing by the photo to the right, this is not an idea that's taken hold in my head as of yet. Please don't make the same mistake. :)

You'll also want to rotate the hobbled gear so that the hole for the grub screw is aligned with the little rounded notch that's formed in the body of the filament tensioner. Put a small amount of thread locker on to the grub screw and install & tighten it.

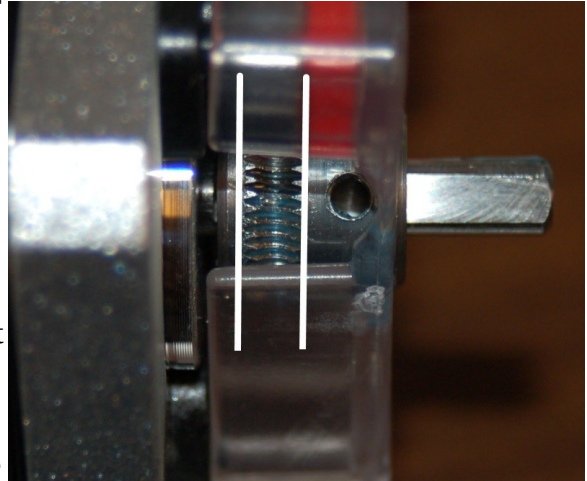

Fig. 10-5: Hobbled gear alignment.

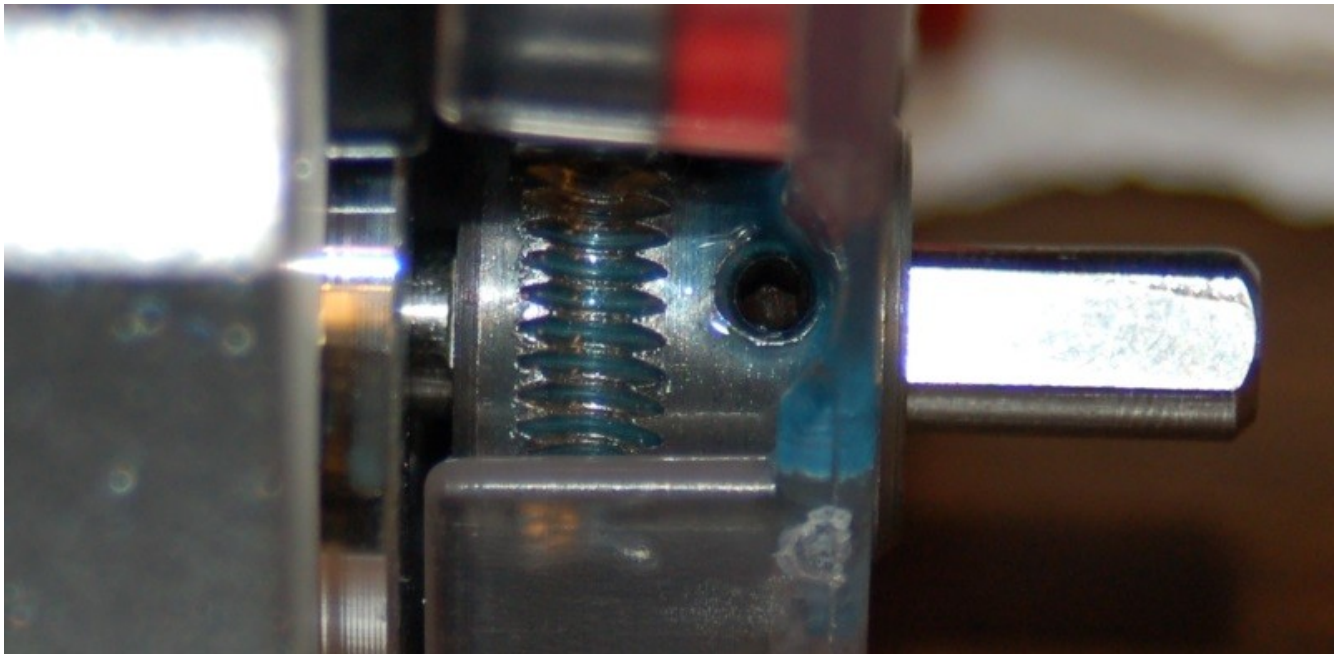

Fig. 10-6: Grub screw installed, mess with thread locker made.

Rostock MAX v2 Assembly Guide

Now you need to install the filament guide block on to the stepper motor.

The filament guide block is installed on to the stepper motor using the two metric screws included in the hardware pack. Using the photo below as a guide, insert the shorter screw in the hole to the right and the longer screw in the hole to the left.

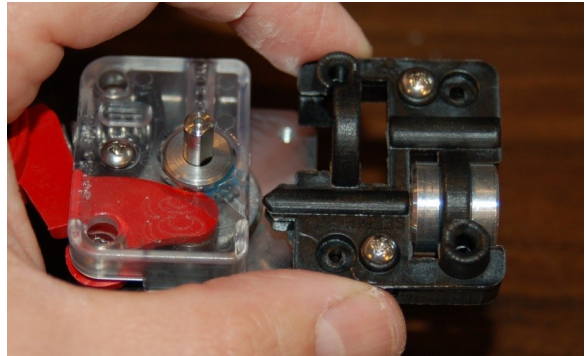

Fig. 10-7: Filament guide block orientation.

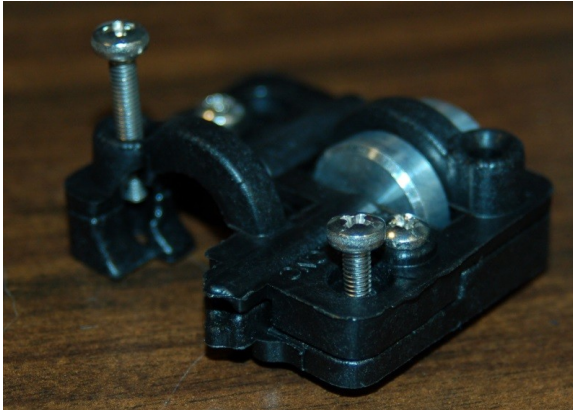

Fig. 10-8: Mounting screw locations.

Set the filament guide block on to the stepper motor and tighten the attachment screws.

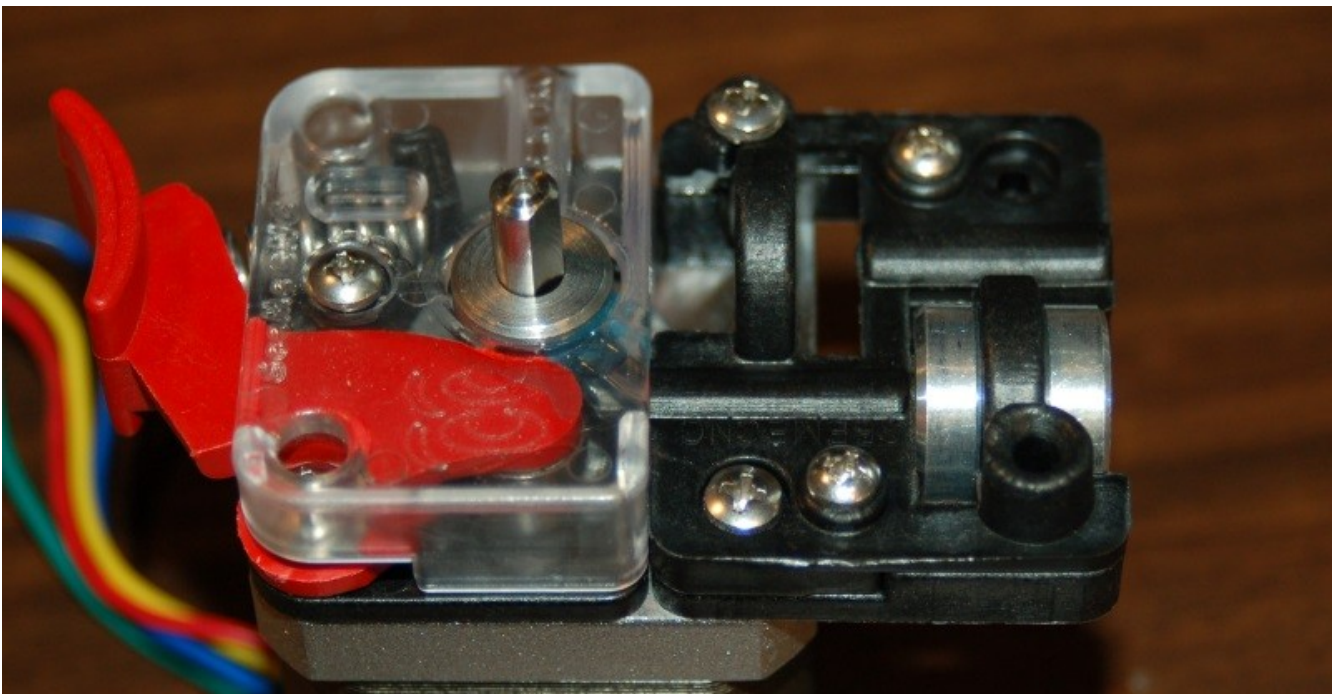
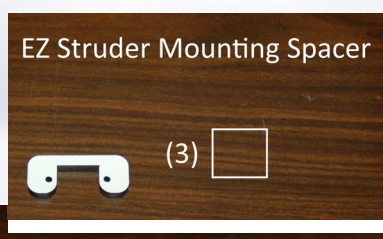
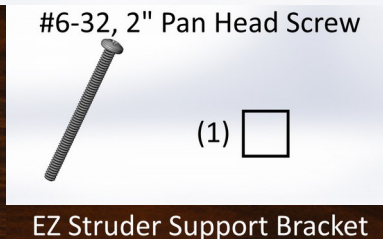
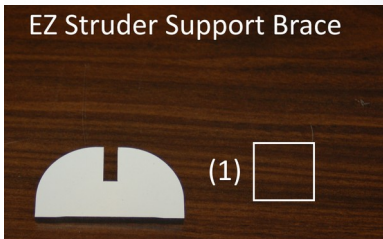
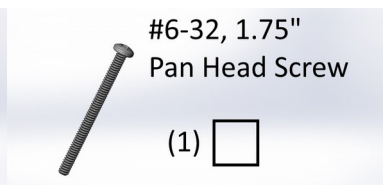
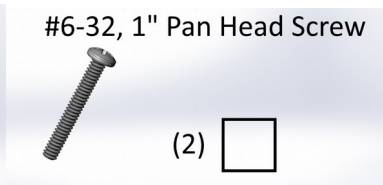
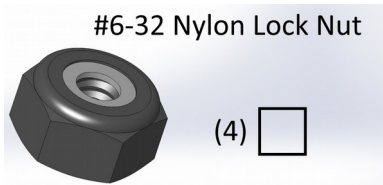

Fig. 10-9: Assembled EZStruder.

Installing & Mounting the EZStruder

For this task, you'll need the assembled EZStruder as well as the following components:



Push Fit Connector

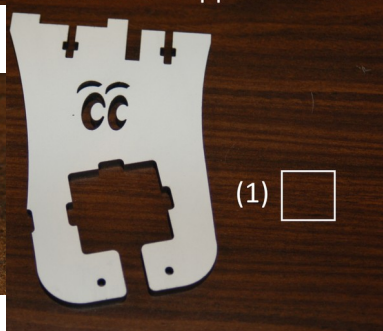

Stepper Knob

Rostock MAX v2 Assembly Guide

The first thing you'll need to do is install the 1.75" and 2" pan head screws into the filament guide block. The holes for the screws are tight, so you'll need to drive them in with a power screwdriver in order to more easily cut threads into the plastic. When you've gotten them all the way in, run them in a bit more to strip out the threads you just cut. It will make installing the nylon lock nuts easier. The 1.75" screw goes in on the left, the 2" screw goes in on the right – see Fig. 10-10.

Now you can install the mounting spacers on the two screws.

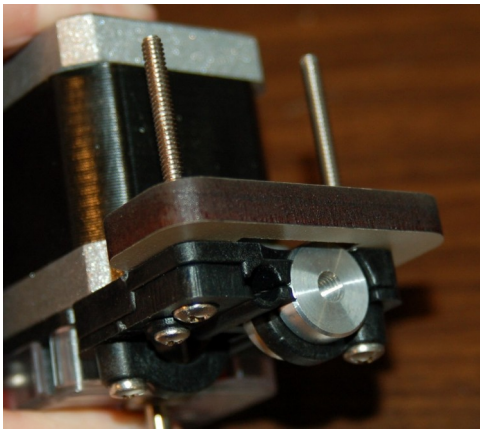

Fig. 10-11: Starting the spacer stack...

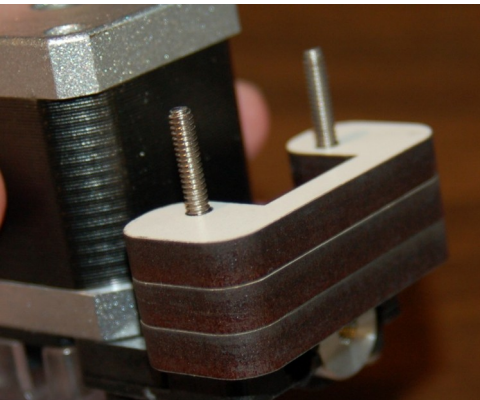

Fig. 10-12: ...and finishing it!



Fig. 10-10: Screw locations.

Rostock MAX v2 Assembly Guide

To install the EZStruder on to the support bracket, orient the EZStruder and support bracket as shown in Fig. 10-13.

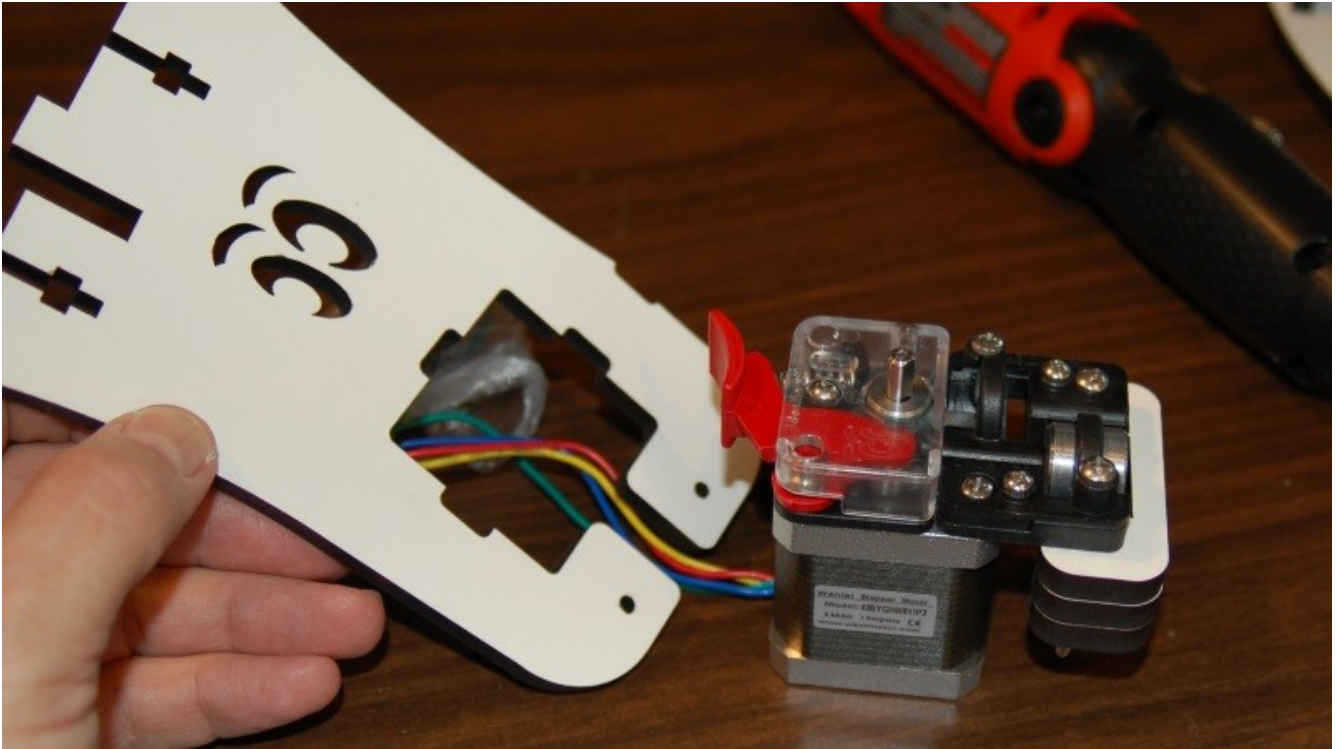

Fig. 10-13: Bracket & EZStruder orientation.

Carefully slide the stepper motor through the square opening in the bracket and guide the two screws into their mating holes on the bracket as shown below. The stepper is a tight fit, but it does fit properly once the input angle is taken out of it.

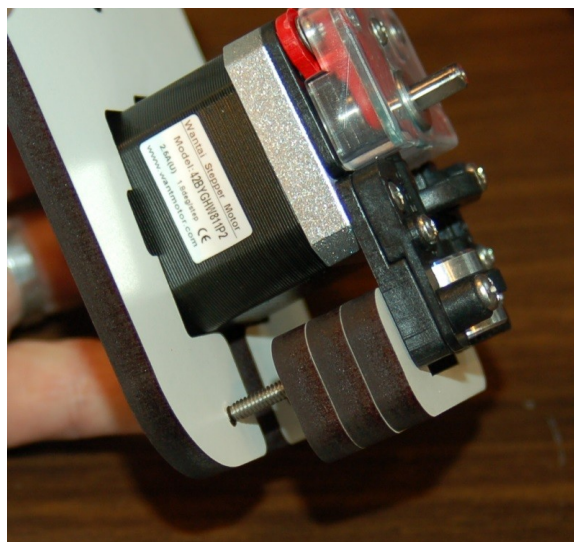

Fig. 10-14: Fitting the EZStruder to the bracket.

Rostock MAX v2 Assembly Guide

Now thread on and tighten two #6-32 nylon lock nuts as shown below.

Before you can attach the EZStruder bracket to the printer, you'll need to do a few tasks first. First up, install the stepper motor knob on to the output shaft of the stepper motor. This knob will allow you to manually feed filament if you need to.

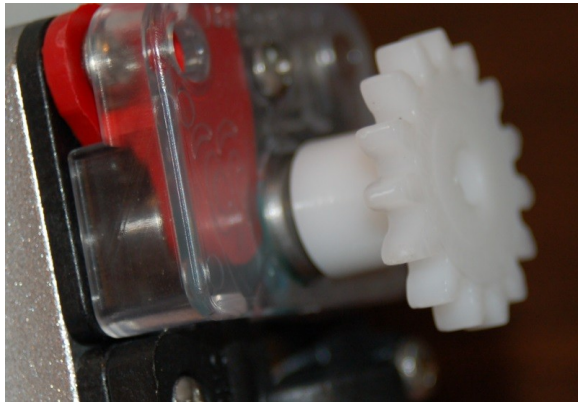

Fig. 10-16: Stepper knob installed.

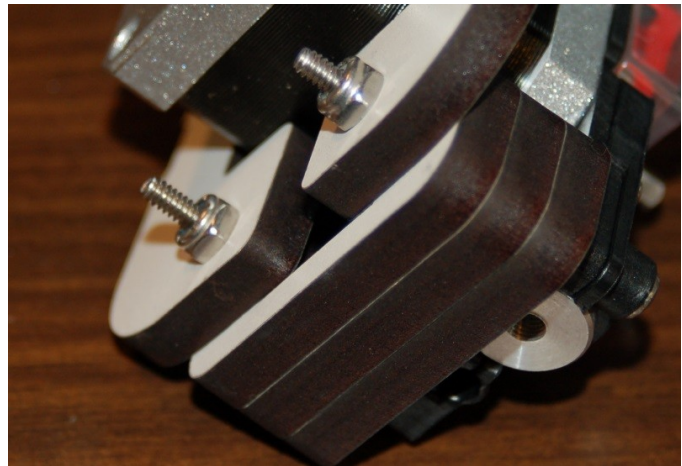

Fig. 10-15: EZStruder installed.

Next, you'll need to install the brass push fit connector to the bottom of the filament guide as shown in Fig. 10-17. Only make it finger tight!

Finally, you'll need to install two #6-32 nylon lock nuts into the nut capture pockets in the top of the EZStruder bracket, as shown.

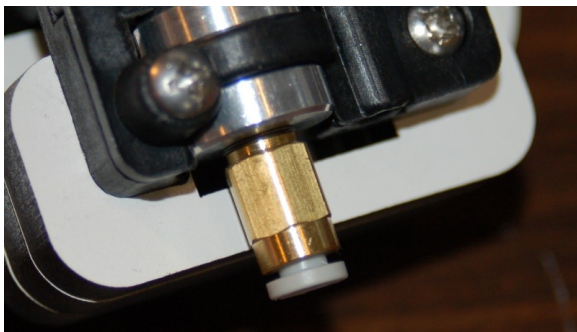

Fig. 10-17: Push fit connector installed.



Fig. 10-18: Nuts installed.

Now we can move on to attaching the EZStruder bracket to the top of the printer!

Rostock MAX v2 Assembly Guide

Slide the EZStruder bracket support brace on to the EZStruder bracket as shown.

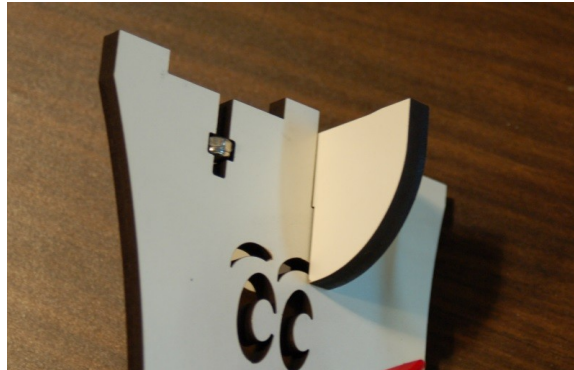

Fig. 10-19: Support brace installed.

Now set the EZStruder bracket into the mounting slots in the top of the printer. It may be easier to do this if you lay the machine down horizontally.

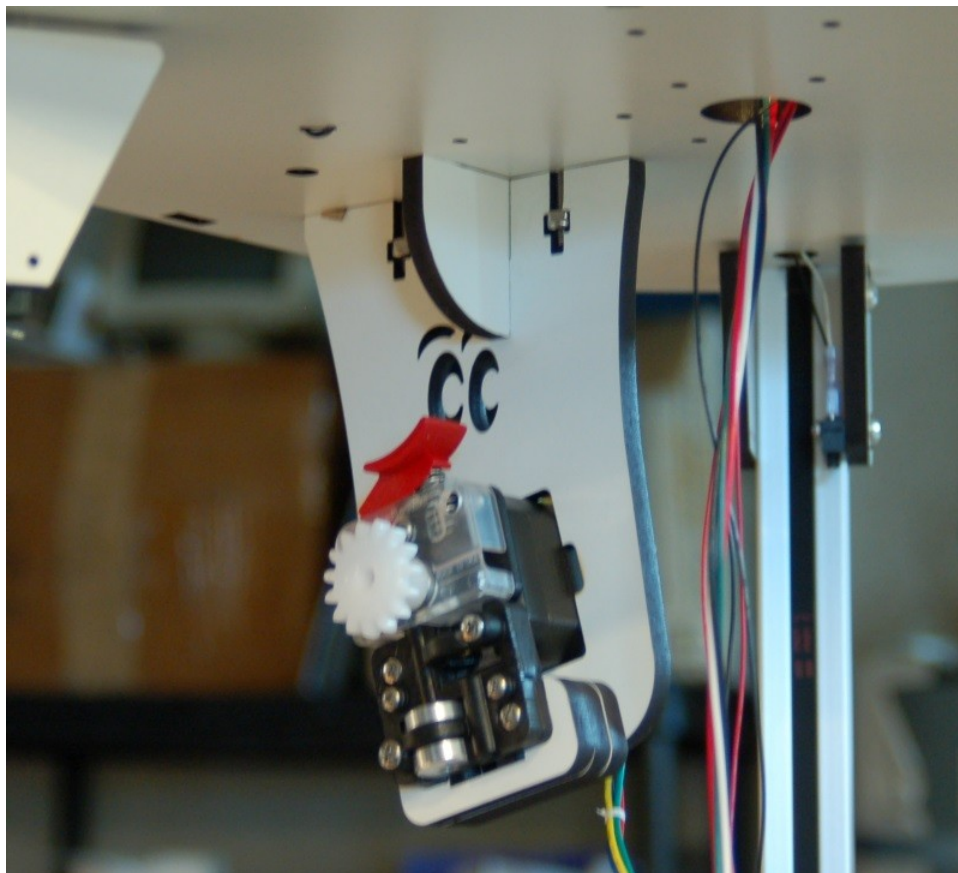

Fig. 10-20: EZStruder mount ready for screws.

Rostock MAX v2 Assembly Guide

Insert two #6-32, 1" pan head screws into the locations shown. They should fit into the nuts in the EZStruder bracket perfectly. Tighten them down and we'll move on to wiring up the stepper motor!

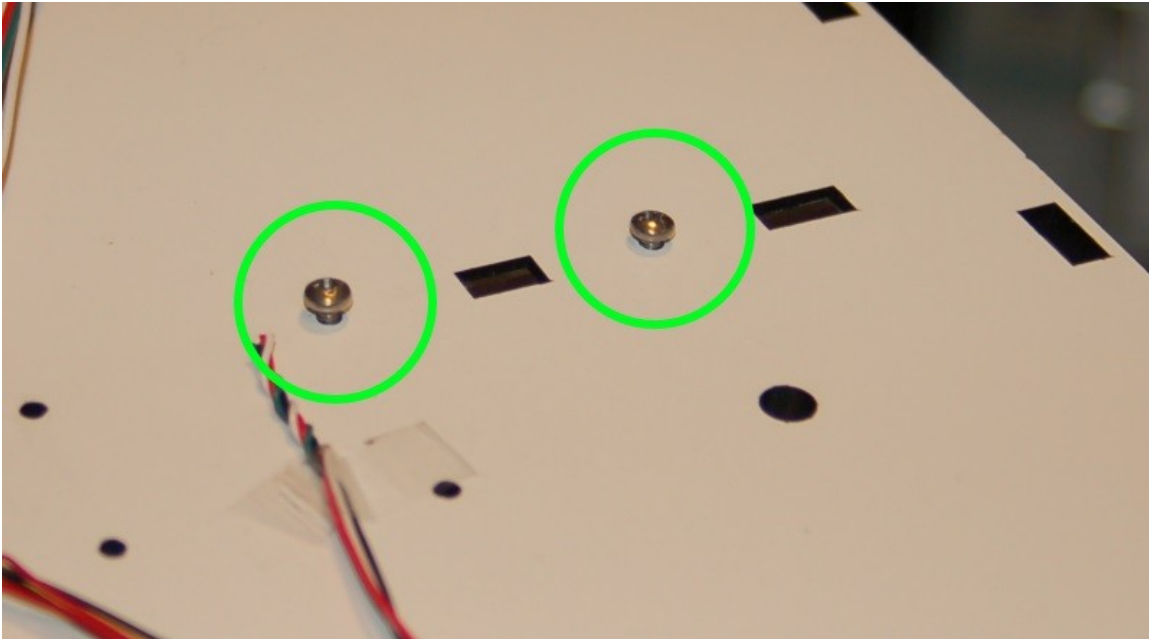

Fig. 10-21: Bracket screw holes.

Wiring the EZStruder Stepper Motor

Route the stepper motor wires through the center hole in the top plate. I've laid the machine horizontally to make working on the top end easier.

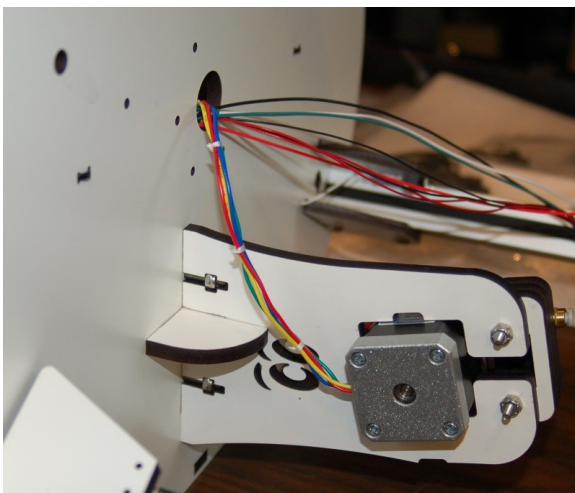

Fig. 10-22: Routing the stepper wires.

Now you'll want to use a short wire tie to bind the wiring of the stepper motor to the EZStruder bracket as shown below.

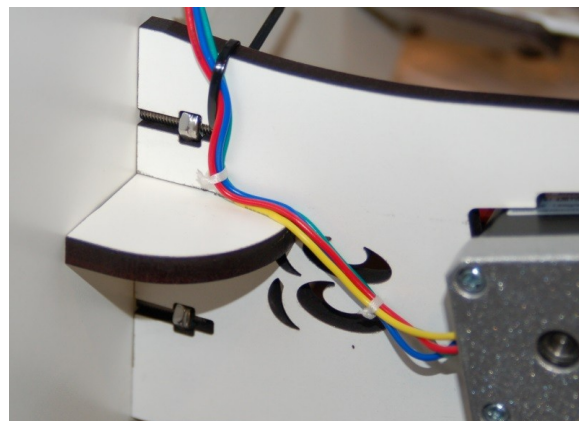

Fig. 10-23: Wires tied in place.

Rostock MAX v2 Assembly Guide

As shipped, the stepper motor wires are a lot longer than they need to be. Trim the stepper motor wires so they overlap with the ends of the Y tower fed wires by about 3 inches.

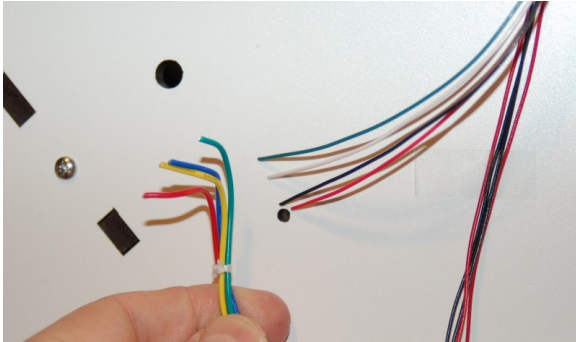
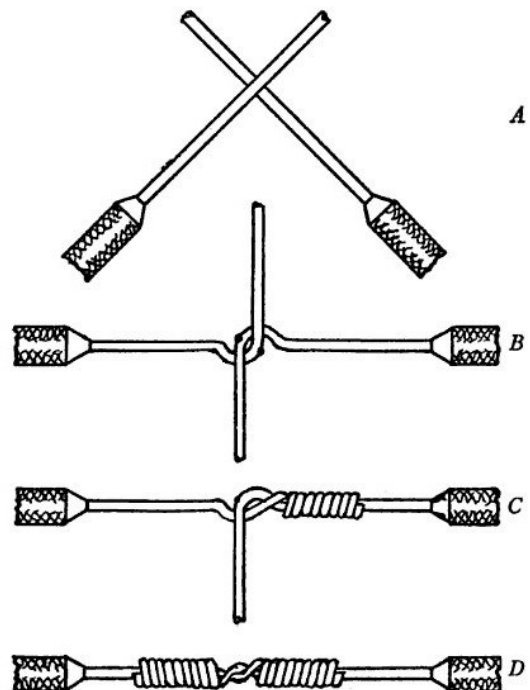
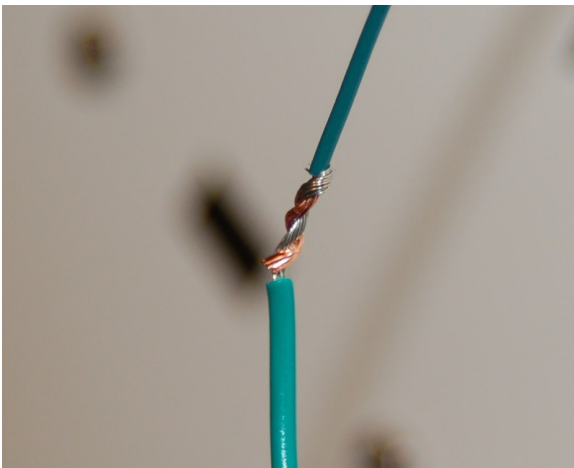

Fig. 10-24: Trimmed to length.

Strip about 1/2" of insulation off both the stepper motor wires and the feed wires coming from the Y tower.

If you've never spliced wire before, I'd recommend using a simple splice called a Western Union Splice. You can see how it's done below in Ill. 10-1.

Below is an example of what the splice looks like.



16

Ill. 10-1: A Western Union Splice.

Rostock MAX v2 Assembly Guide

I would recommend that if you use this splice, you solder the joint before covering it with Kapton tape.

You can also use heat shrink tubing if you've got some handy – it's personal preference really.

When splicing the wires together, please follow the chart below. This is important in order to get the pin assignments correct when you add the connector to the other end of the extension cable. (The connector & pins are supplied as part of the RAMBo parts kit.)

If you're color-blind, please get some assistance with this step. Getting the wires backwards will make you crazy. :)

Pin	Stepper Color	Extension Color
1	Green	Green
2	Red	Red
3	Blue	Black
4	Yellow	White

Table 10-1: Wiring Color Chart.

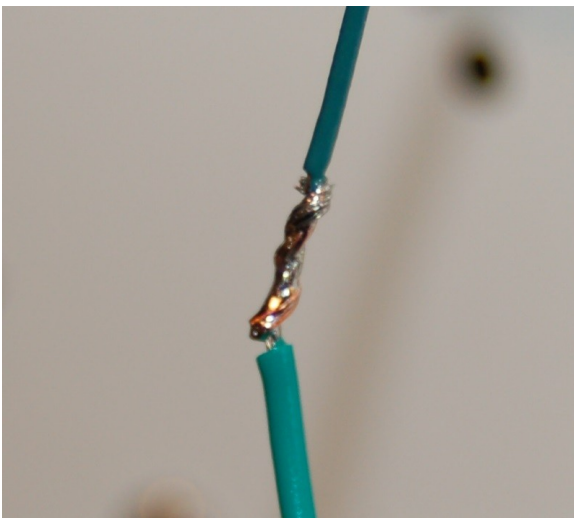

Fig. 10-26: Soldered...

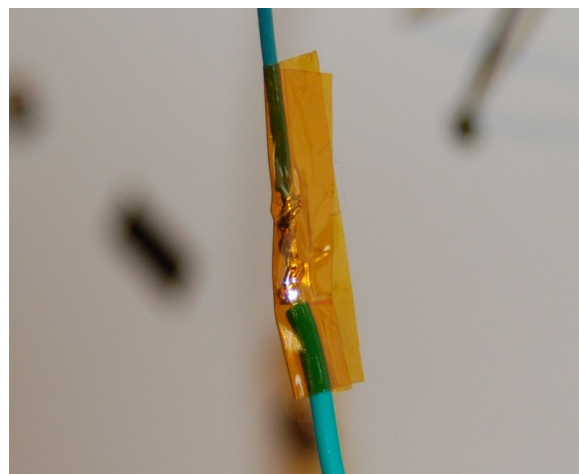

Fig. 10-27: ...and enclosed in Kapton tape.

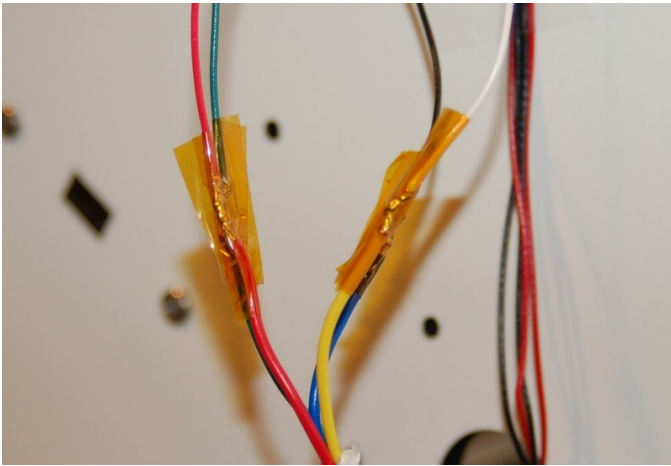

Fig. 10-28: All four wires done!

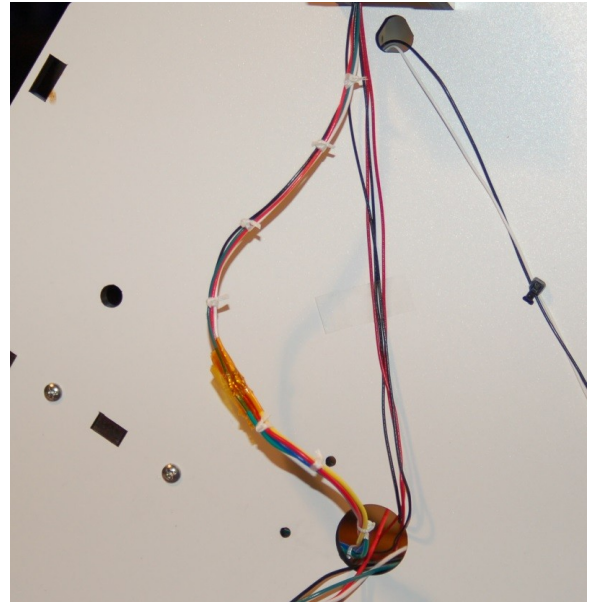

Fig. 10-29: Completed extruder wiring.

You'll note that the wires in Fig. 10-29 bend away from the black & white end stop wires on the far right. This is done on purpose. This is done in order to keep the motor wires way from the two small end-stop wires. If they're run in close parallel with one another, they can pick up current from the stepper motor and cause false end-stop triggers to be reported. If that happens, the printer does very, very odd things.

Checkpoint Video #14: http://youtu.be/0NF_g86H4hQ

11 – Installing the Hot End and Bowden Tube

Preparing the Hot End Wiring

For this task, you'll need the short length of heat shrink tubing and the 3/8" Black, Expandable Mesh Loom.



Mesh wiring loom and heat shrink tubing.

Rostock MAX v2 Assembly Guide

Before we begin the task of installing the wire loom, I want you to take a second and tie down the hot end wires. This is an earlier step that was delayed until this point.

Use a few short bits of Kapton tape to hold the hot end wires in place. This will ensure that they don't move over time and cause signal problems with the end stop wires to the left.

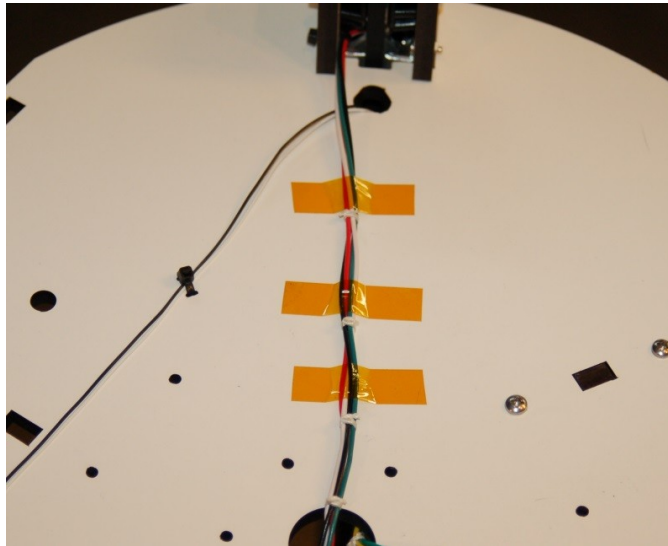

Fig. 11-1: Taping down the hot end wiring.

Cut a 26" long section of mesh loom. The material will cover the hot end wires from the top plate to a point about 2.5" short of the end of the wires. Tape the hot end wires together and slide the mesh loom section you just cut over them.

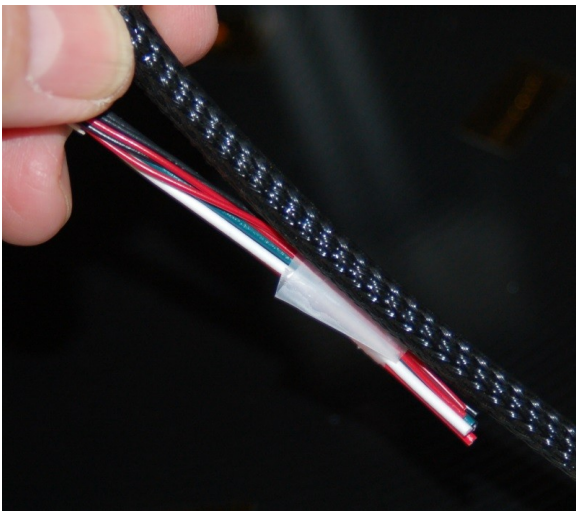

Fig. 11-2: Wires and mesh loom.

Make sure that when you slide the loom over the hot end wires that it reaches up to the center hole in the top, plus a little bit more.

Now, I want you to cut the heat-shrink tubing in half – you should end up with two bits about an inch long. Slide it over the bare-wire end of the mesh loom. Adjust it such that half is covering the mesh and half is covering the wire as indicated by the line in Fig. 11-3.

Rostock MAX v2 Assembly Guide

Using a hair dryer or heat gun, heat the tubing until it conforms to the loom & wires as shown in Fig. 13-5. Keep the heat source moving around the tubing as it shrinks to get an even shrink all the way around.

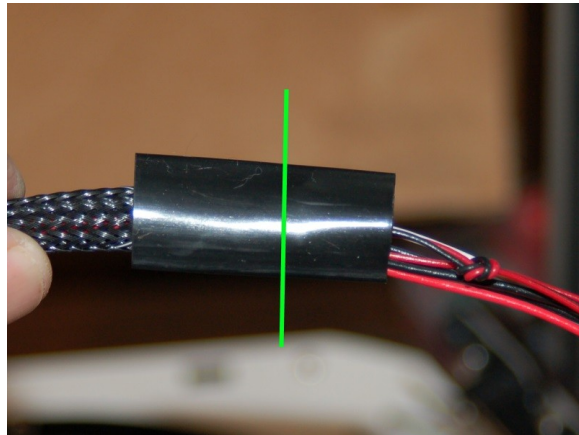

Fig. 11-3: Positioning the heat shrink.



Fig. 11-4: Heat-shrink applied.

Slide the other length of heat-shrink tubing up the loom to the top and shrink it.

Now it's time to prepare the hot end for wiring. By this time, the RTV in your hot end should be fully cured (make sure you've let it cure for at least 24 hours) and it should look like this:

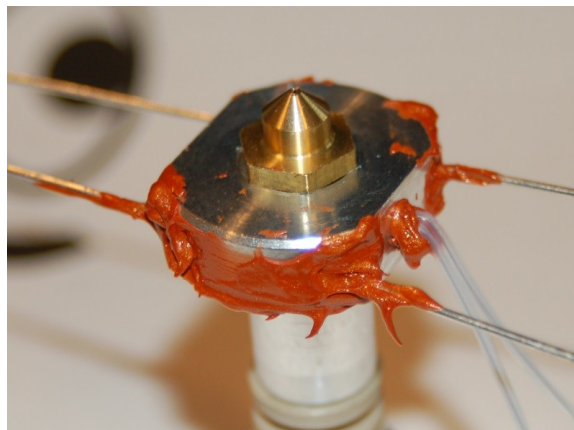

Fig. 11-5: Ready to go!

Rostock MAX v2 Assembly Guide

Before we start the wiring process, I want you to wrap the heater block of the hot end with a few loops of Kapton tape. This will help prevent the thermistor from being pulled out of the hot end if the wiring were to snag on something. If the thermistor comes out of the hot end while it's powered up, the PEEK section (the tan part) of the hot end *WILL BE DESTROYED* when the hot end temperature exceeds 247 degrees Celsius. The reason this happens is due to the firmware on the controller trying to get the hot end to its target temperature based on a thermistor input that is no longer close enough to the heater block to return a reliable reading.

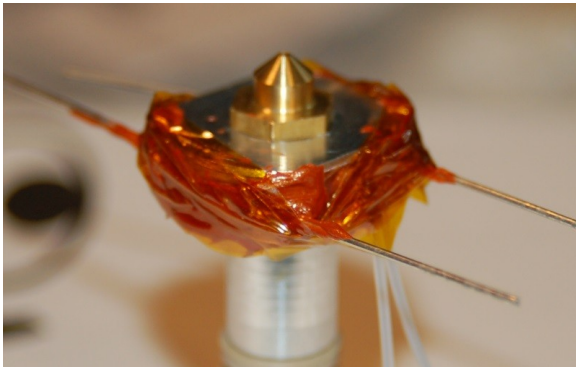

Fig. 11-6: Heater block wrapped in Kapton.

When you've got the heater block wrapped, go ahead and throw a loop around the upper hot section (the aluminum barrel portion). This will act as a bit of insulation to prevent the PEEK fan from inadvertently cooling down the hot end while in operation.

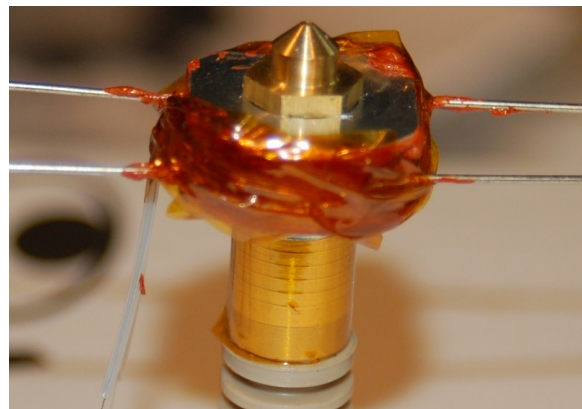

Fig. 11-7: Hot section wrap.

Wiring the Hot End

For this task, you'll need the completed hot end and two 22-16ga un-insulated crimp connectors.



Using a pair of needle nosed pliers, bend the resistor leads as shown in the following photos.

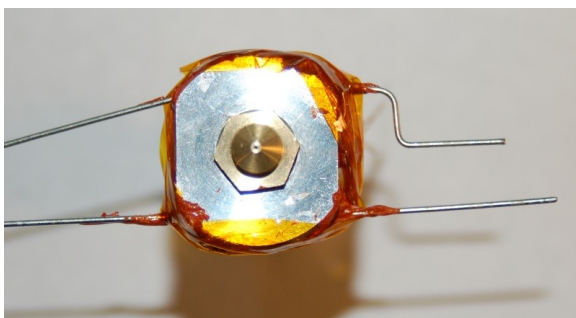

Fig. 11-8: Step #1.

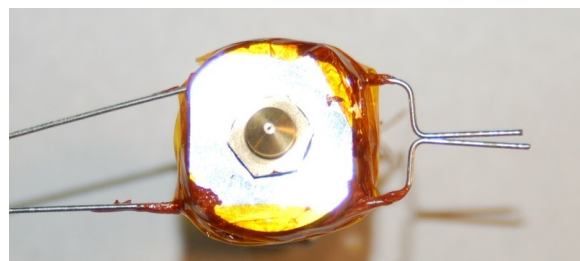

Fig. 11-9: Step #2.



Fig. 11-10: Step #3.

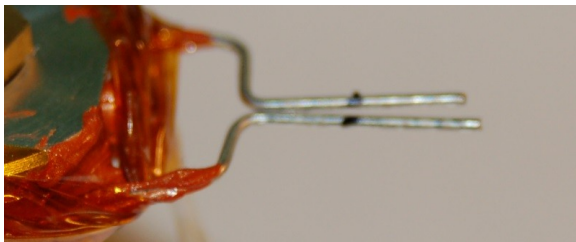

Fig. 11-12: Leads marked for cutting.

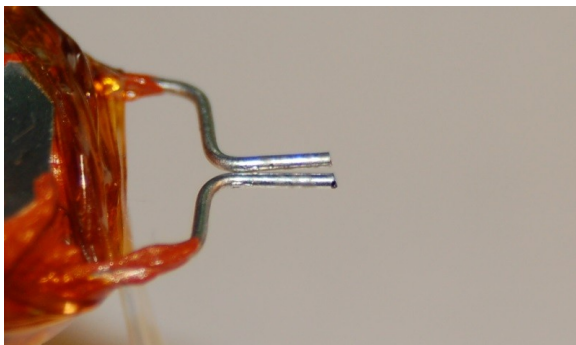

Fig. 11-13: Leads trimmed.

Repeat the process for the leads on the other side of the heater block.

The resistor leads on the hot end are too long to use right now. In order to trim them to the proper length, place one of the crimp connectors along side the wires and mark the wires just behind the center point of the crimp as shown below. Trim the leads off at that mark.

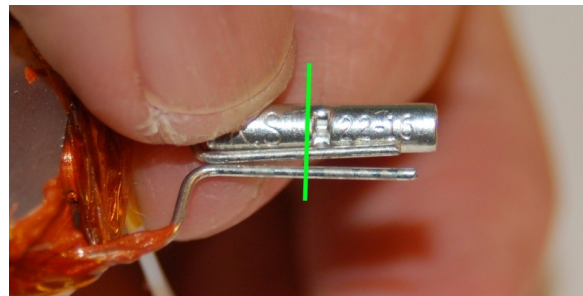

Fig. 11-11: Marking the trim point.

Finally, attach the crimp on connector to the freshly trimmed leads as shown.



Fig. 11-14: Crimp installed.

Rostock MAX v2 Assembly Guide

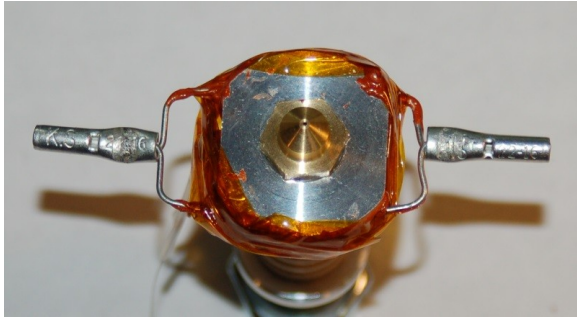

Fig. 11-15: Ready for wires.

Repeat for the other side with the red wire.

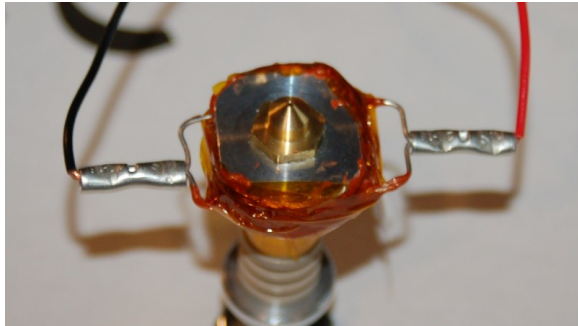

Fig. 11-17: ...and red wire attached.

Now strip off about 3/8" from the two 18ga black & red wires coming out of the hot end loom. These will be attached to the crimps you've just installed. Note that it doesn't matter which side you pick for black and which for red. Resistors don't have a specific polarity, so connection orientation doesn't matter.



Fig. 11-16: Black wire attached.

Bend the leads "up" or towards the open end of the hot end and cover the crimp connectors with Kapton tape. This will help prevent short circuits that could at the least blow fuses or at the worst, damage the RAMBo controller.



Fig. 11-18: Kapton insulation.

Now you'll be attaching the thermistor leads to the 18ga green and white wires in the hot end loom. Please be careful with this task – the thermistor wires are delicate and can be broken easily.

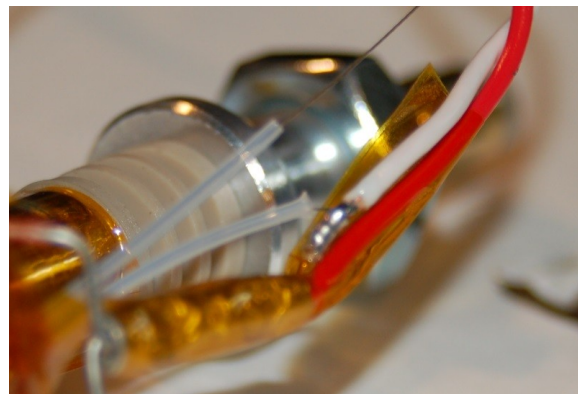

Fig. 11-19: Thermistor lead soldered to white wire.

Rostock MAX v2 Assembly Guide

As soon as you finish soldering the white wire to the thermistor lead, cover the joint with Kapton tape. Solder the other thermistor lead to the green wire and also cover it with Kapton. After you've done that, I want you to use more Kapton and tape the two thermistor leads to the power lead feeding the thermistor side of the hot end as shown.

The reason for this is to provide additional strain relief to the thermistor wiring to help prevent it from being pulled out of the hot end on accident.



Fig. 11-20: Thermistor leads bound tight.

Attaching the Hot End to the Hot End Mounting Plate

You'll need the following components to complete this task:

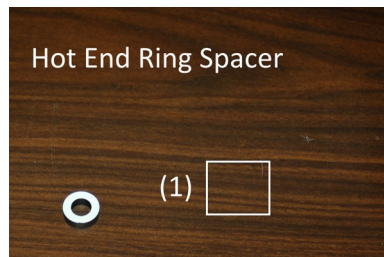
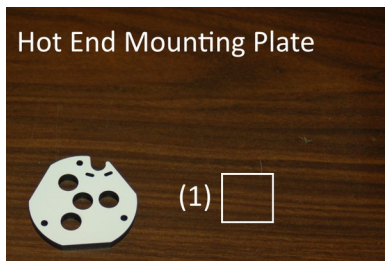

You'll also need one short wire tie and the freshly wired up hot end.

Before you can install the hot end in the hot end mounting plate, you'll need to remove both the press-fit connector and the mounting nut as shown below.

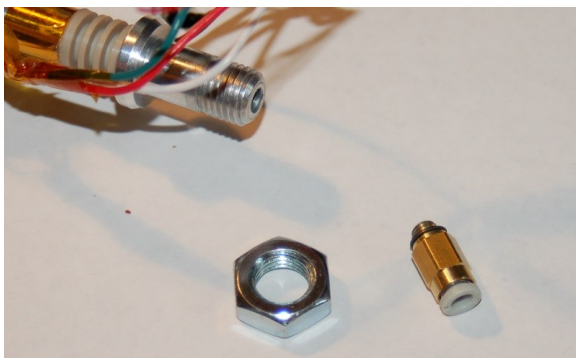

Slide the hot end into the center mounting hole on the hot end mounting plate.

Fig. 11-21: Nut & press-fit removed.

Next, slide the hot end ring spacer over the hot end.

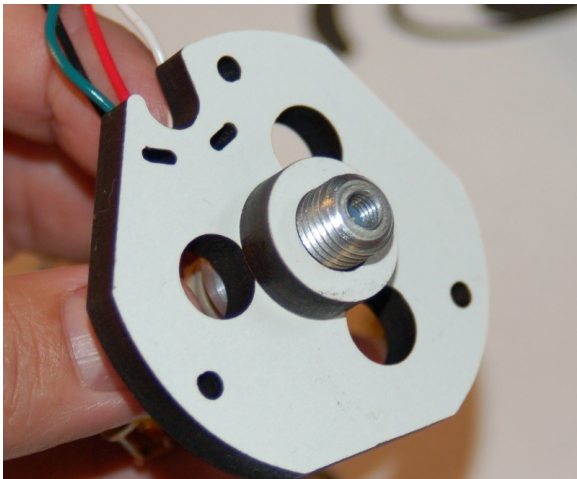

Fig. 11-23: Spacer installed.

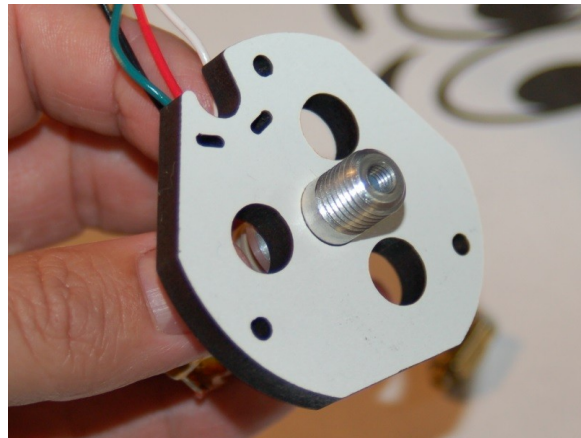

Fig. 11-22: Hot end mounting plate.

Now fix the hot end in place by re-installing the large retaining nut and tightening it.

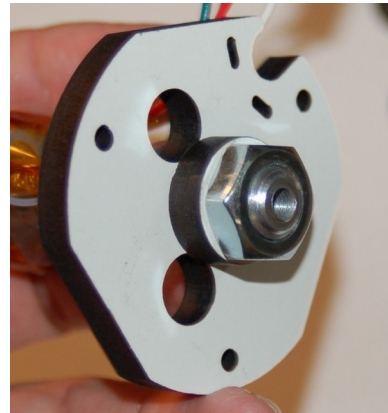

Fig. 11-24: Nut attached.

Now flip the hot end over and press the wiring into the strain relief notch in the hot end mounting plate as shown.

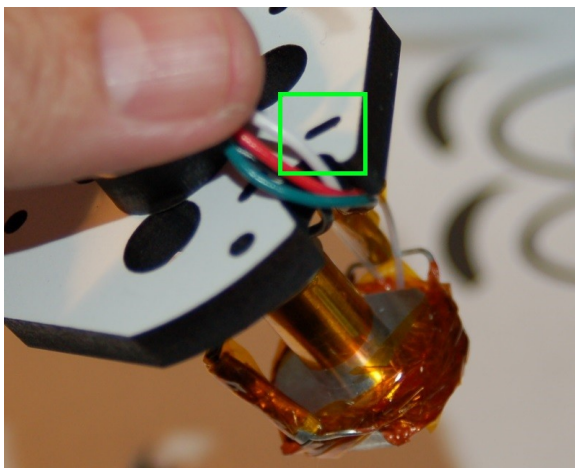

Fig. 11-25: Strain relief notch.

Bind the hot end wires into place using a wire tie. Insert the wire tie through the slot highlighted in green in Fig. 11-25.

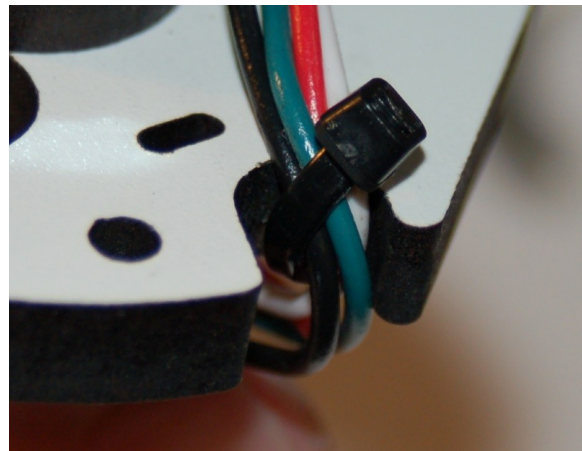

Fig. 11-26: Hot end wires tied into place.

Finally, re-install the press fit connector at the top of the hot end. Finger tight is sufficient.



Fig. 11-27: Press fit connector re-installed.

Installing the Bowden Tube

For this task you'll need the long PTFE Bowden tube that was included in the Hot End Pack.

The mesh in the hot end wiring loom will open up when you compress it. Grip the mesh about 2" above the heat shrink tubing and press down with the hot end on the table. This will open up the mesh enough so that you can insert the Bowden tube. Insert the tube 1" from the upper edge of the heat shrink tubing as shown below.



Fig. 11-28: Entering the loom at the bottom.

Thread the Bowden tube up the loom to a point about 2-1/2" short of the press fit connector on the extruder.

Open up the loom at that point and allow the Bowden tube to exit.

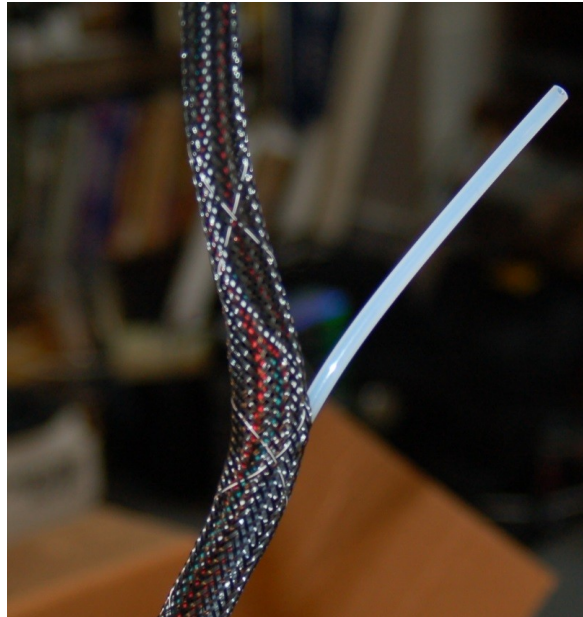

Fig. 11-29: Exiting the loom at the top.

Pull the tube through the loom until you have enough to insert the end into the press fit connector on the bottom of the EZStruder.

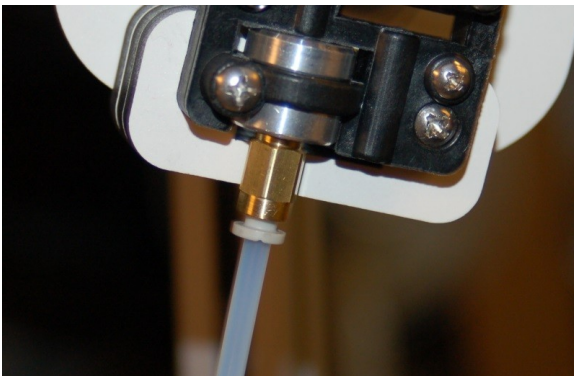

Fig. 11-30: Bowden inserted into the EZStruder.

Finish by inserting the tube into the hot end's press fit connector.



Fig. 11-31: Bowden in the hot end.

Checkpoint Video #15: http://youtu.be/gAEvIQ_FsMQ

12 – Installing the Effector Platform and Delta Arms

Assembling the Effector Platform

For this task, you'll need the following components:

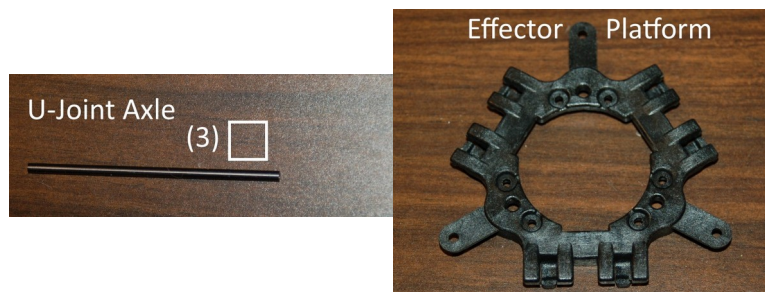

Rostock MAX v2 Assembly Guide

Assembling the effector platform consists of inserting the three steel axle rods into the clips on the platform.



Fig. 12-1: Inserting an axle.

The axle fit on the effector platform is VERY tight. This is by design. Wiggling the axle as you slide it into the retaining tabs can help it fit. Holding the axle against a table while you press down on the platform may help as well.

The axle should be as centered as you can make it. I use the fan mounting tabs as a visual alignment guide.

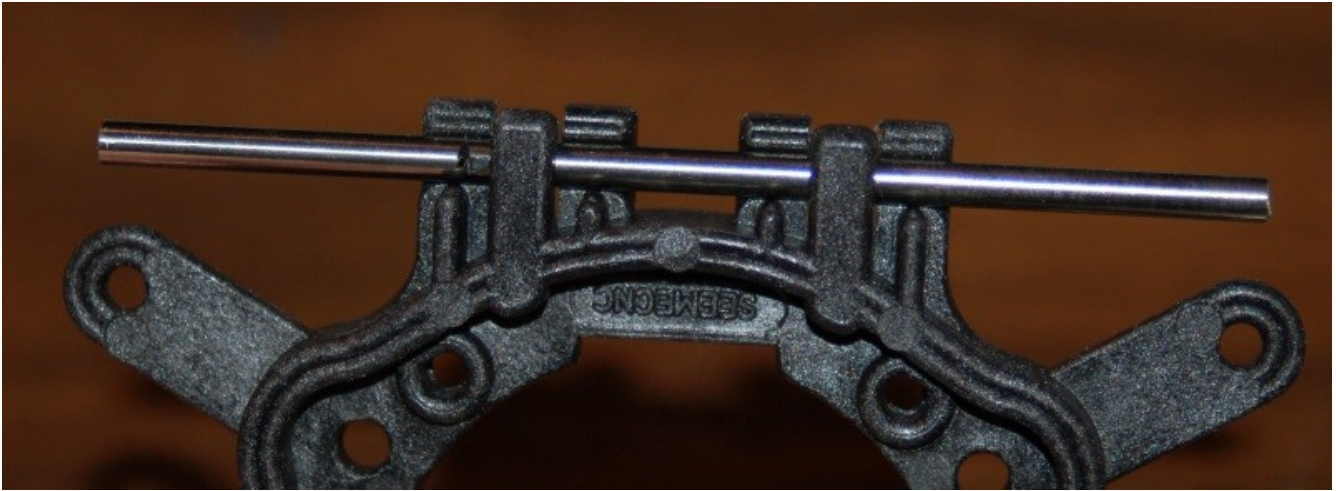

Fig. 12-2: Aligned axle installation.

Now go ahead and install the other two axles into the effector platform.

A quick note about part orientation – you'll notice in Fig. 12-2 above, you can see “SEEMECNC” printed on the part. This is the bottom of the effector platform. Fig. 12-3 on the right shows the platform “face up”. This is the orientation you'll want to install it when you perform the next task.

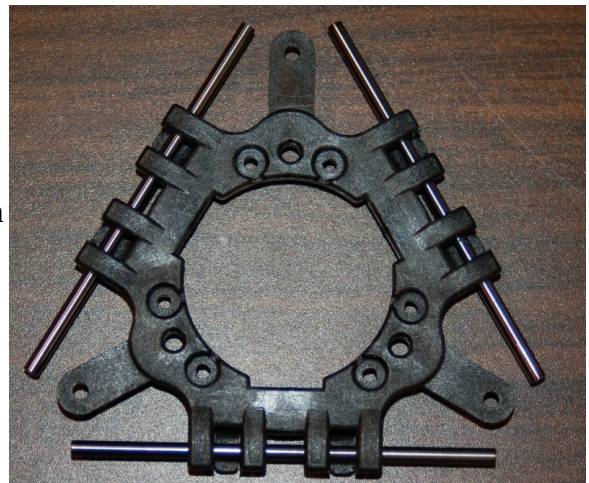
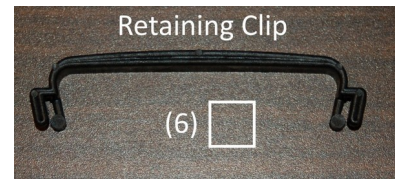
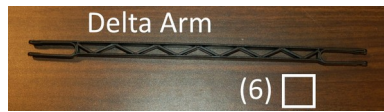
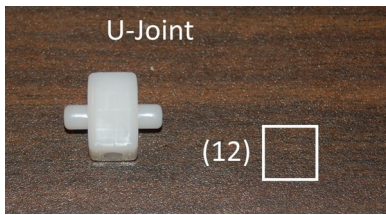

Fig. 12-3: All three axles installed.

Installing the Delta Arms

For this task, you'll need the following components:



Before installing the delta arms, clean the mold flashing from the inner and outer faces of the arm tips that will come in contact with the u-joints. You can do this easily with an X-Acto knife.

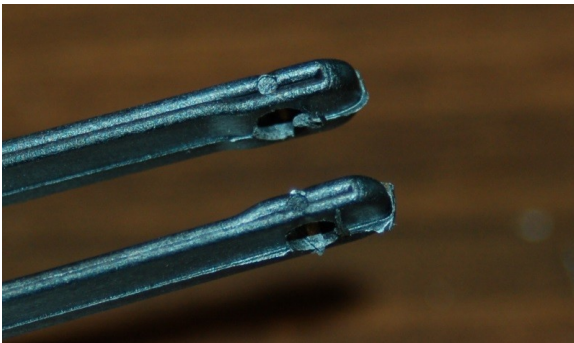

Fig. 12-4: Mold flashing.



Fig. 12-5: Cleaned off.

After you've got the mold flashing removed from the ends of the delta arms, install one u-joint into the end of each delta arm. Do this for all six delta arms.

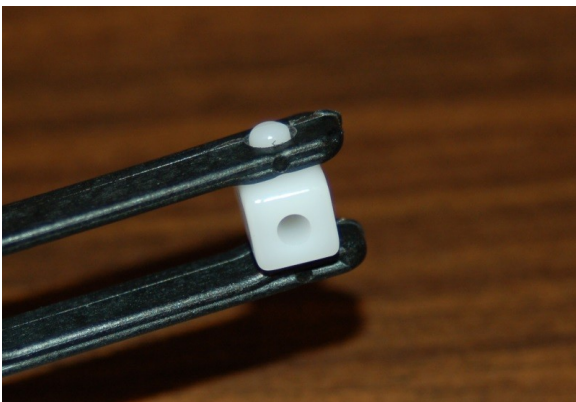

Fig. 12-6: U-Joint installed.



Fig. 12-7: Ready to go!

Rostock MAX v2 Assembly Guide

Before you start attaching the delta arms to the Cheapskates, move the hot end out of your way by looping it over the Y tower as shown below.



Fig. 12-8: Hot end out of the way.

We're going to the delta arms on the Cheapskates first. Simply slide the arm on to each axle end as shown, taking care to make sure that the previously mentioned ejector pin marks are face out as shown in Fig. 12-10.

The injection molded u-joints have two small, round marks on one face. These marks are from the ejector pins that kick the parts out of the mold when they're done. You need to make sure that when you slide the u-joints on to the axles that these ejector pin marks are facing out. We don't want them rubbing against the u-joint carriage mounts or the effector platform.

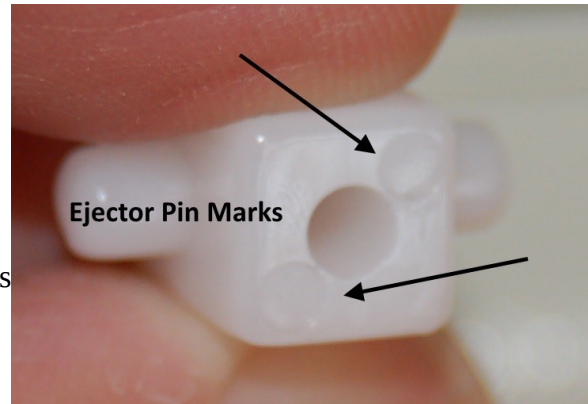

Fig. 12-9: Ejector pin marks.

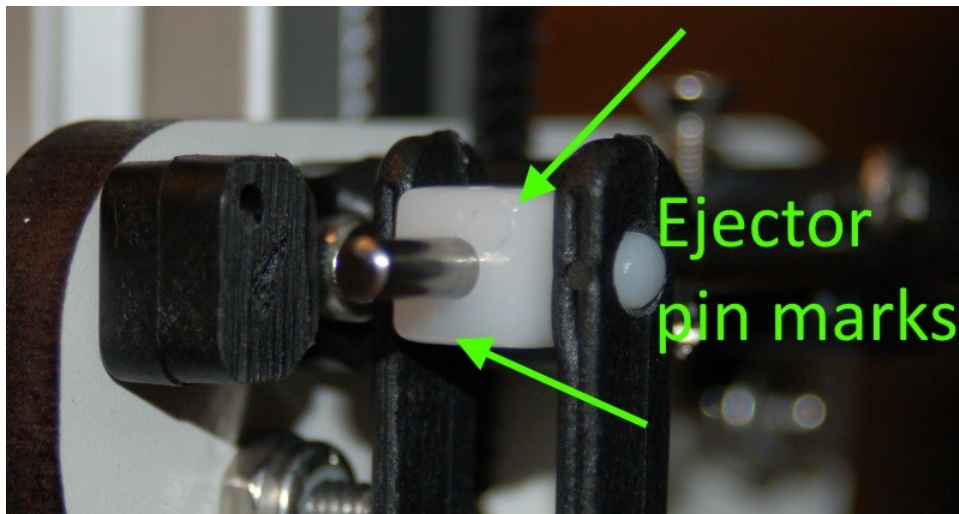

Fig. 12-10: Installing a delta arm.

Rostock MAX v2 Assembly Guide

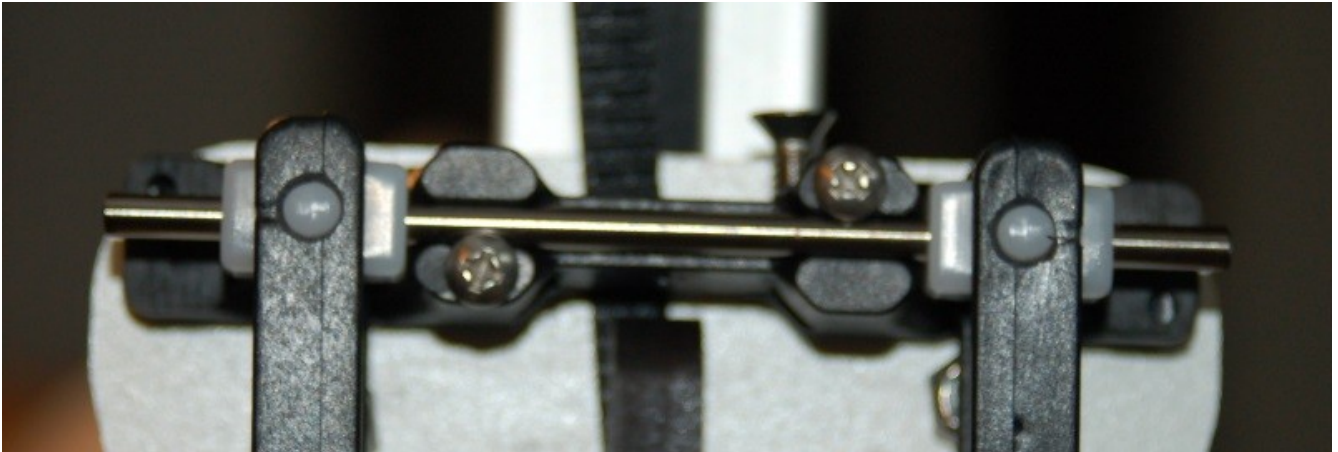

Fig. 12-11: Two arms installed.

With two arms on the Cheapskate, you now need to install a retaining clip. The clips slide in from the side, between the “fork” on the end of the delta arm as shown below.

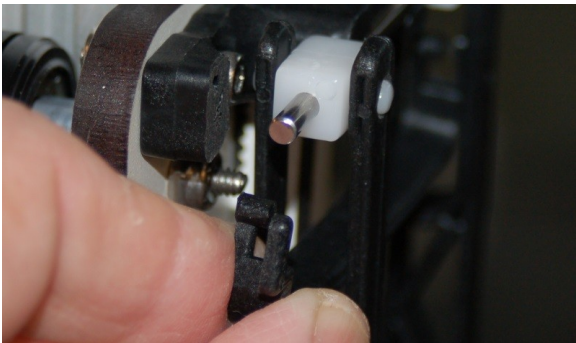

Fig 12-12: Retaining clip installation.



Fig. 12-13: Clip is seated on the axle.

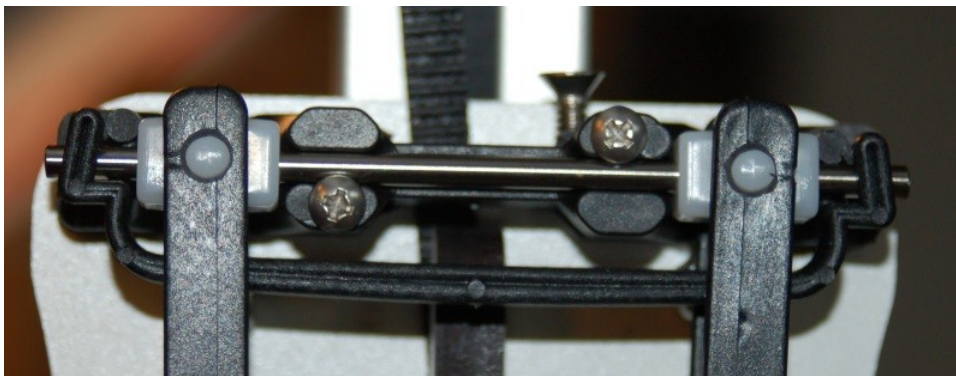

Fig. 12-14: Clip fully seated.

Repeat this task for the arms on the other two Cheapskates.

Rostock MAX v2 Assembly Guide



Fig. 12-15: All six arms installed.

Attaching the Effector Platform

For this task, you'll need the remaining three retaining clips and the assembled effector platform. The delta arms attach to the effector platform just as they did to the Cheapskates. Take care to make sure the ejector pin marks are facing outward!

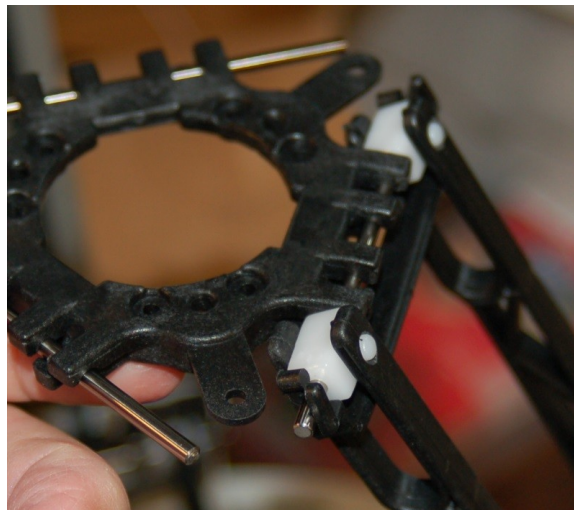

Fig. 12-16: First two arms attached.

Rostock MAX v2 Assembly Guide

Attaching the delta arms to the effector with the Cheapskates at the bottom will cause the platform to be raised off the bed as shown below. This will make the next task a lot easier.

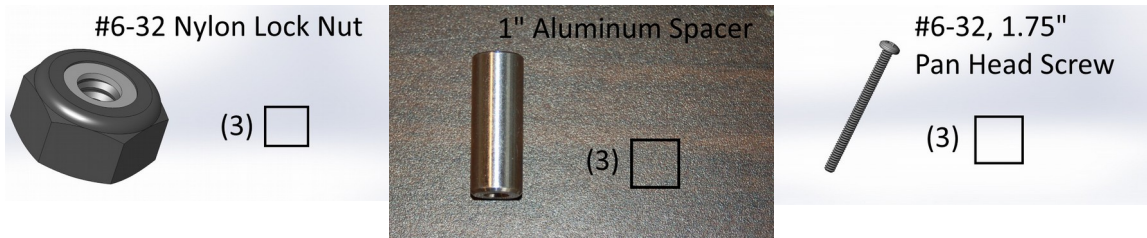

Fig. 12-17: Platform ready for the hot end!

Checkpoint Video #16: http://youtu.be/6GPLyV_8CZI

13 – Installing the Hot End

For this task you'll need the following components:



You should also have a soft cloth that you can cover the Onyx heated bed with. That way if you accidentally drop a tool during the installation, you won't damage or scratch the bed.

Start the installation by inserting a 1.75" pan head screw through the bottom of the platform and then slide a spacer over it as shown.

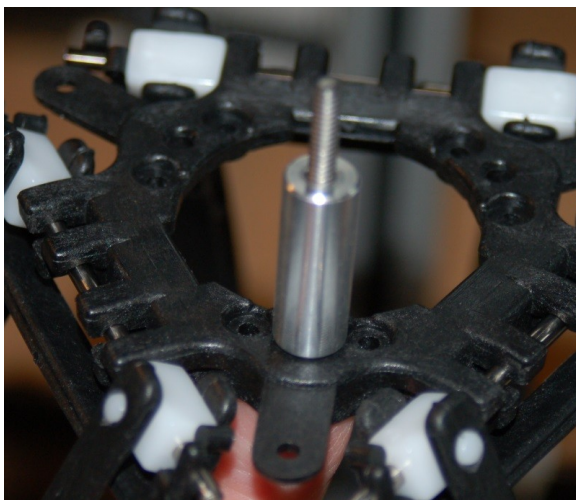

Fig. 13-1: First screw ready.

Repeat this task for the other two screws.

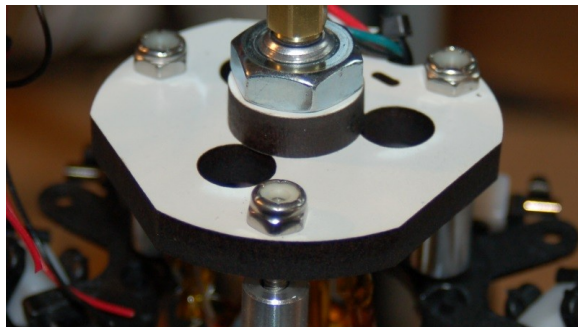

Fig. 13-3: Ready to tighten!

Next, set the hot end on the screw and thread a #6-32 nylon lock nut on the screw. It doesn't need to be tightened yet – we just want it there to keep the screw from falling out the bottom.

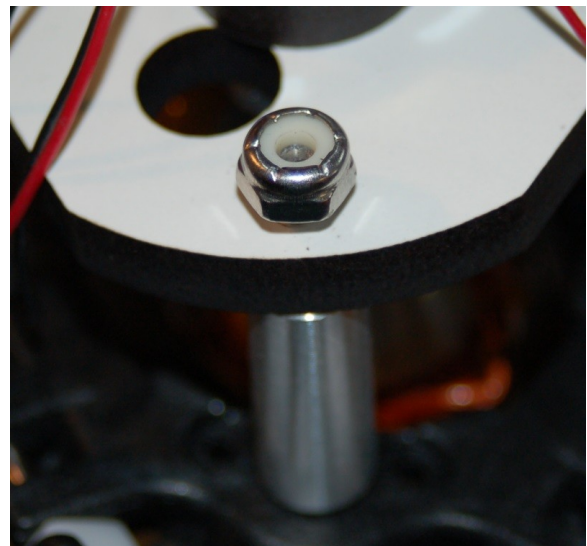

Fig. 13-2: First of three done.

Rostock MAX v2 Assembly Guide

The reason you're installing the hot end with the nuts on top is that the interior sides of the effector platform can make it problematic to reach the nut when it's close to being tight. This way, you can hold a wrench on to the nut on the top and drive the screw in quickly from the bottom. This is another spot where a power screwdriver is the perfect tool for the job!

Go ahead and tighten all three screws – you'll need a 5/16" wrench for the nuts.

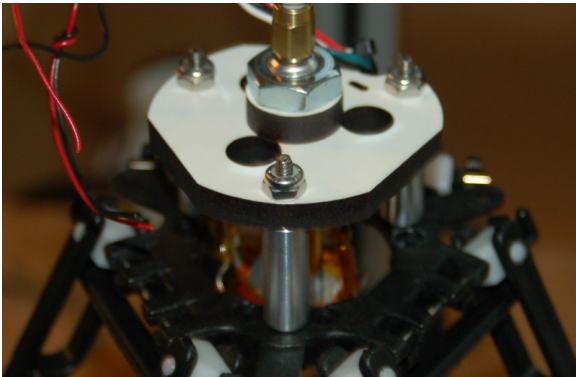

Fig. 13-4: Installation complete!

To complete this step, gently pull up on each Cheapskate, one at a time in order to place the hot end into “operating” position.

If you're transporting your printer anywhere, it would be a good idea to invert the effector platform before you take it for a ride. It'll prevent the hot end from striking the bed or anything else.

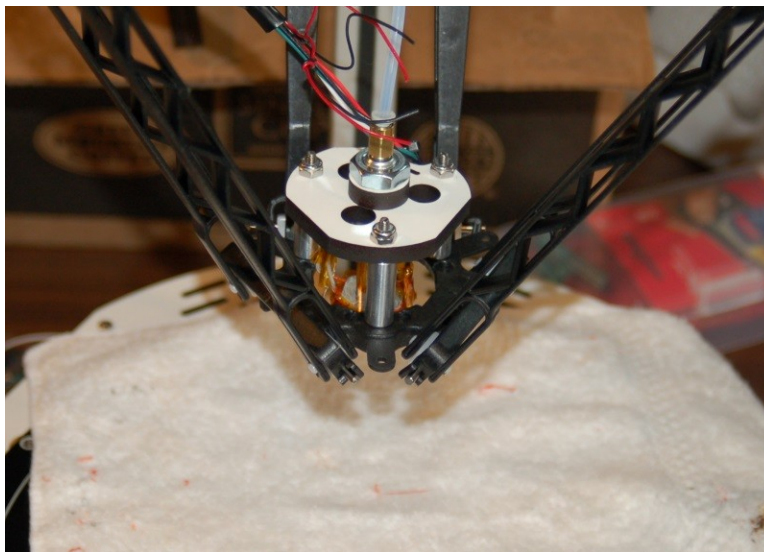

Fig. 13-5: Business end down!

Checkpoint Video #17: <http://youtu.be/vEleiIq3pgM>

14 – Finishing the Top End

Installing the Spool Holder

For this task, you'll need the following components:



The first step is going to be installing two #6-32 nylon lock nuts into the spool holder brace as shown in Fig. 14-1.

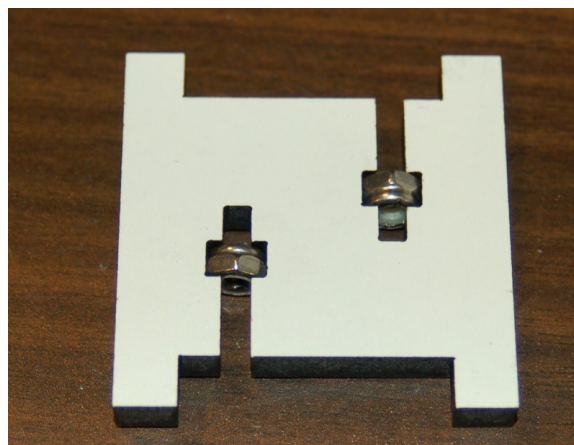

Fig. 14-1: Spool holder brace done.

Rostock MAX v2 Assembly Guide

Now install the brace into the inner spool holder support. Make sure you've got the support oriented as I show in the photo. Use a #6-32, 1" pan head screw to fix it in place.

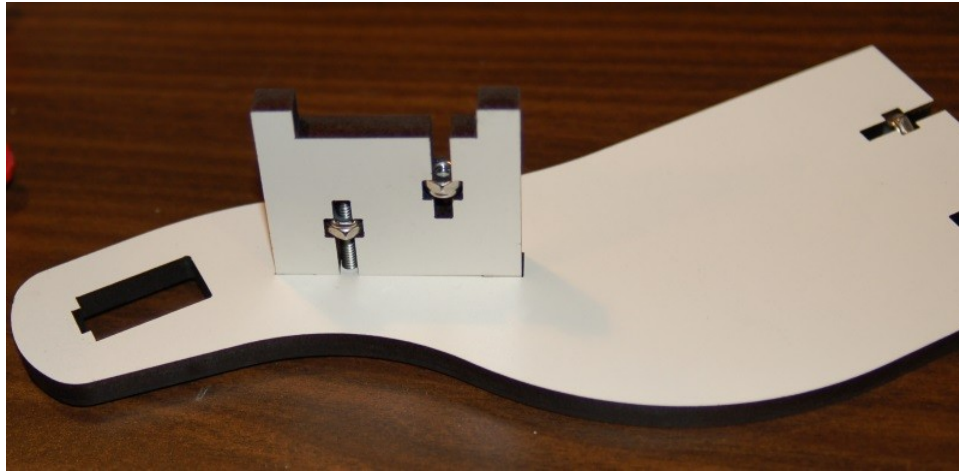

Fig. 14-2: Brace installed in inner spool support.

Now attach the outer spool holder support to the brace using a #6-32, 1" pan head screw as shown to the right.

Flip over the assembled spool holder and insert three #6-32 nylon lock nuts into the nut capture pockets.



Fig. 14-3: Nuts installed.



Fig. 14-4: Assembled spool holder support.

Rostock MAX v2 Assembly Guide

The spool holder support is attached to the printer's top plate using the three holes highlighted below.

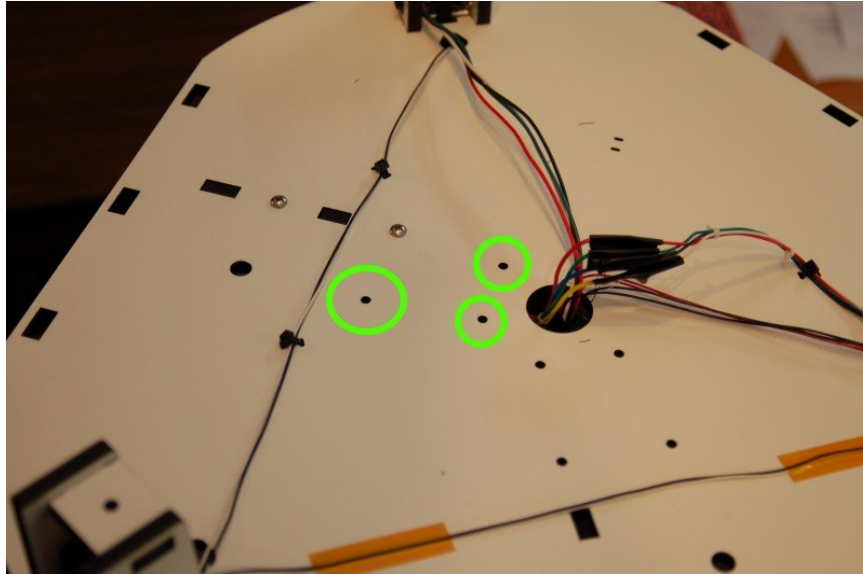

Fig. 14-5: Spool holder mounting holes, top view.

Hold the spool holder support in place with your left hand while you carefully feed in and finger tighten the three #6-32, 1" pan head screws used to fix it in place.

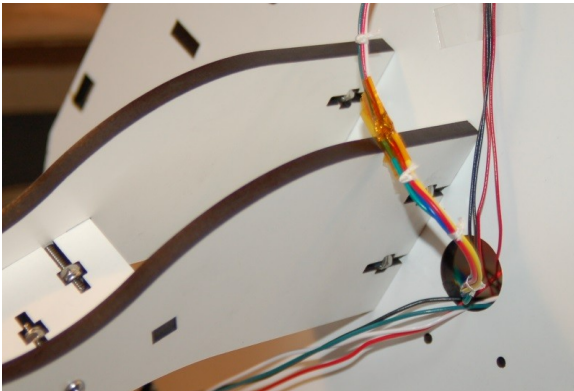

Fig. 14-6: Spool holder support installed.



Fig. 14-7: Screw locations, bottom view.

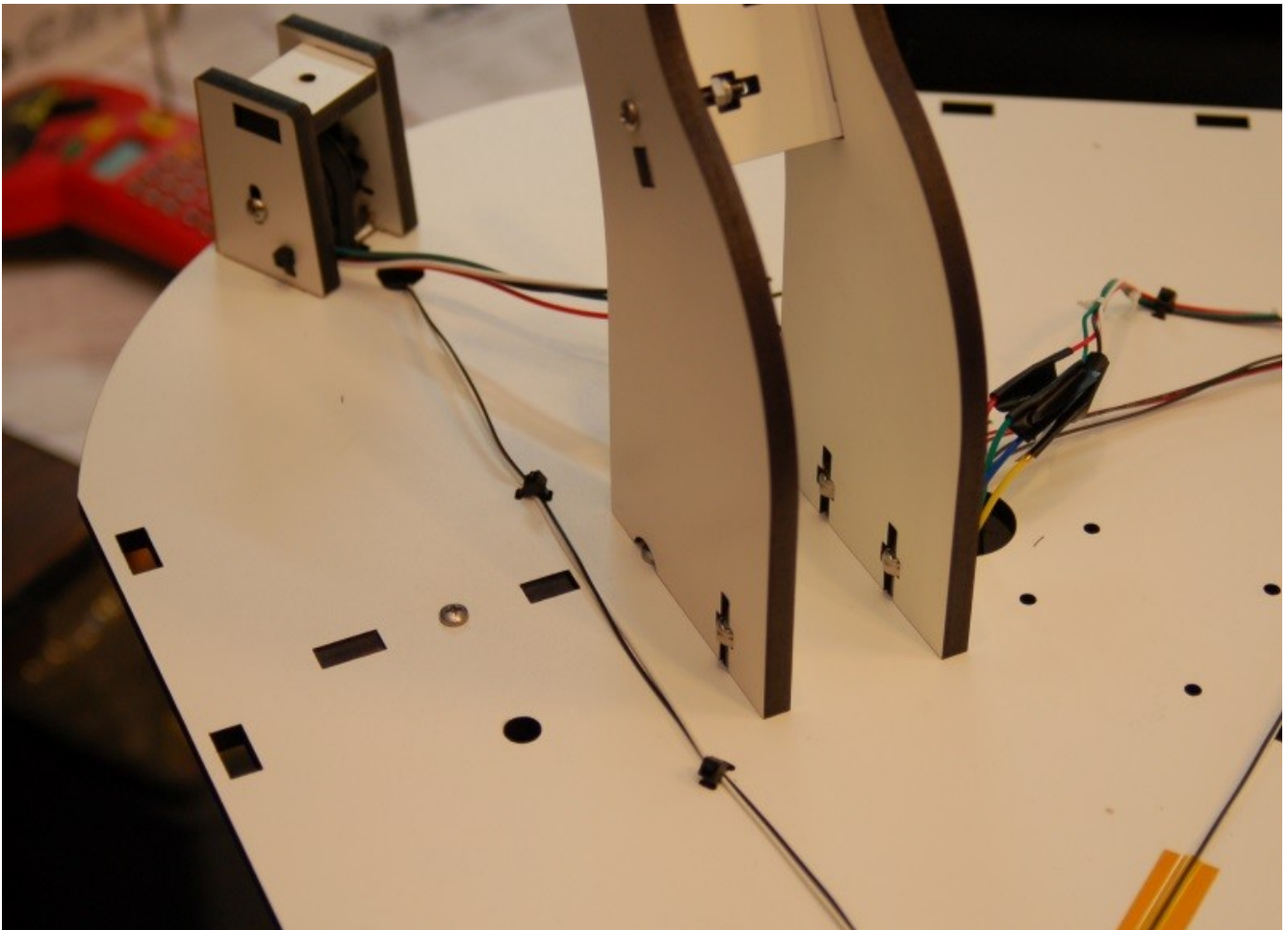

Fig. 14-8: Spool holder support installed.

Installing the Top Plate and Spool Support Arm

For this task, you're going to need the following components:



Before we can install the top section vertical supports, we'll need to install two #6-32, 1/2" flat head screws in each one. They need to be installed on the inside face (opposite of the SeeMeCNC logo engraving).

Remember that you only want to drive the screw in until the tip of the screw is flush with the outside face of the part, just like you did on the vertical supports in the base.

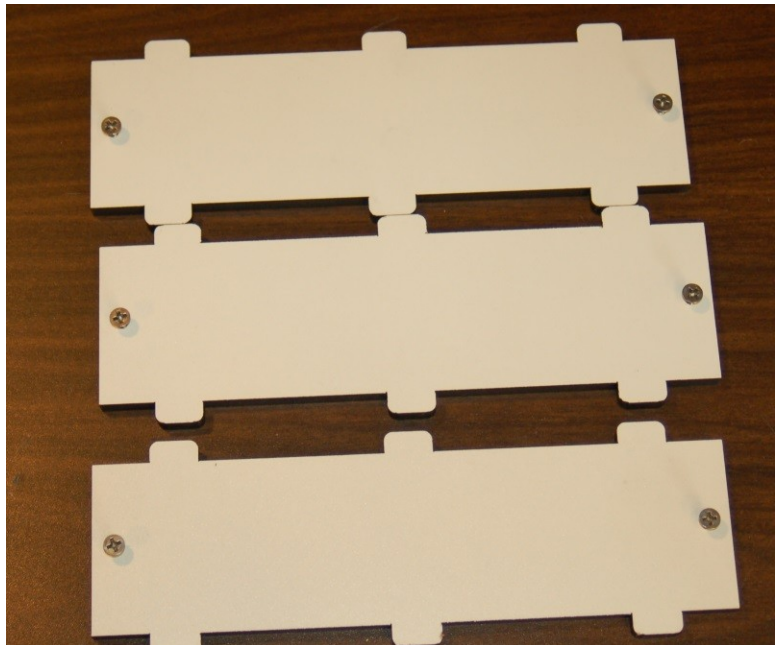

Fig. 14-9: Screws installed.

Rostock MAX v2 Assembly Guide

Now you can insert each one of the vertical supports on each “side” of the top. The tolerance for the tabs is VERY tight. If you're unable to get the tabs to seat properly, you can use a “squeeze” clamp to help fit the vertical support into place. Take care not to blow out the slots in the top though!

You should set the machine on the floor for these tasks – it'll make it them LOT easier to do!

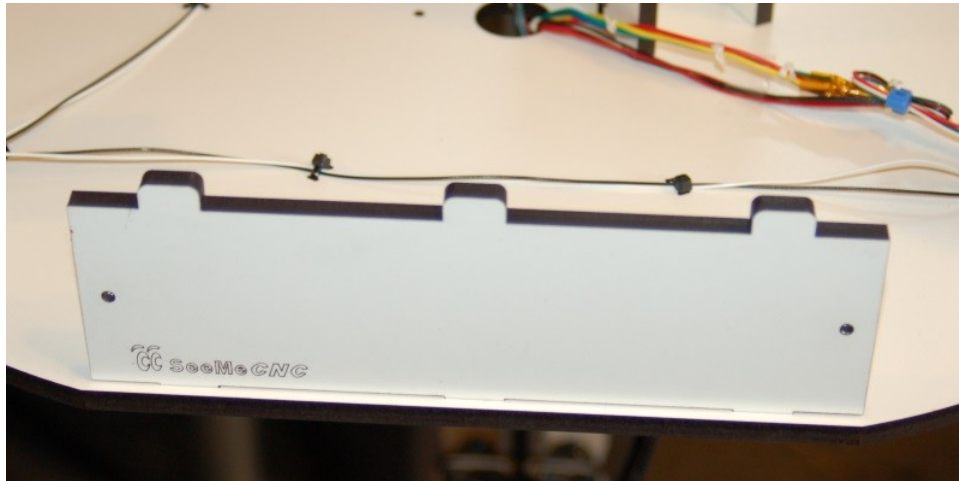

Fig. 14-10: First vertical support installed.

Install the other two vertical supports and then we'll get the top on!

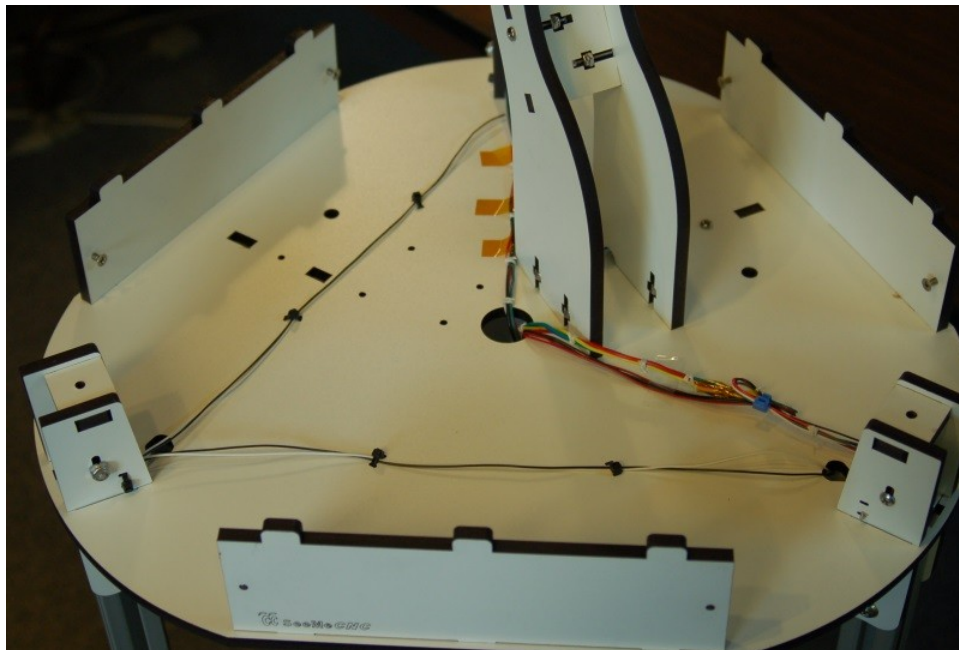

Fig. 14-11: Vertical supports installed.

Rostock MAX v2 Assembly Guide

Install the top by aligning it as shown below and fitting the tabs from the three vertical supports into the slots in the top. Work your way around the perimeter, doing a bit at a time until it's fully seated.

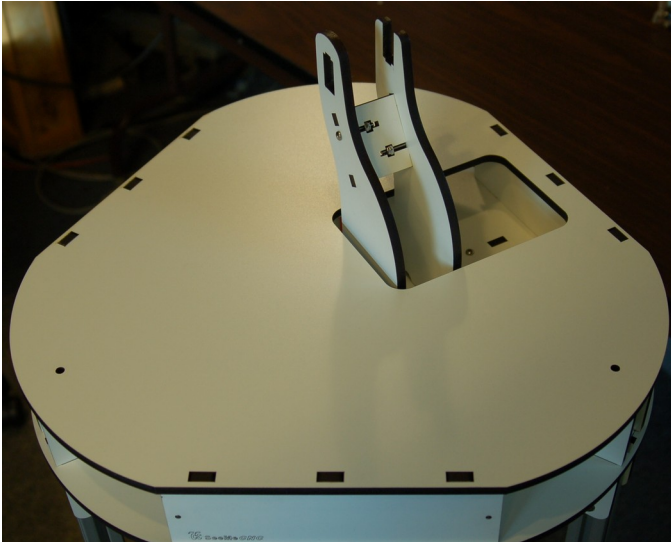

Fig. 14-12: Top set in place...

Now you need to install one #10-32 nylon thumbscrew in the hole at each “corner” of the top in order to lock it into place.



Fig. 14-13: Thumbscrews installed.

Congrats! There's one last step to take before the mechanical build of your Rostock MAX v2 3D printer is completed!

That's right, you need to install the spool holder **IN** the mount! Now pay close attention, this is **brutally** complex.



Fig. 14-14: Arms together now!

First, put your arms together. No, not YOUR arms, ^^^^ those arms. Jeez.

Rostock MAX v2 Assembly Guide

Now oh so carefully, slide the arms (no, your arms won't fit) into the spool holder as shown.

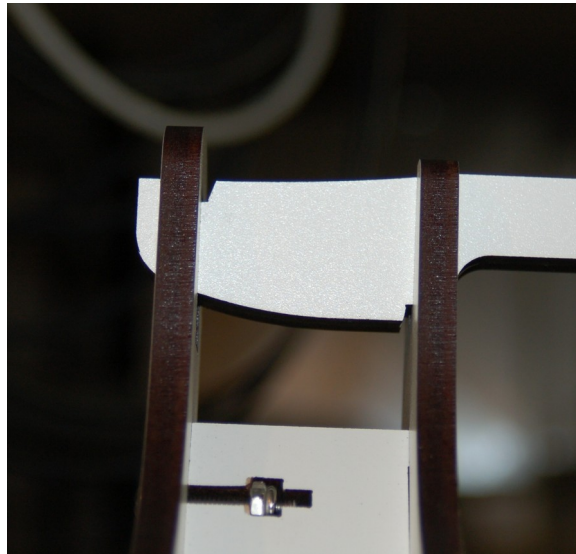

Fig. 14-15: Not your arms.

TA DA!



Fig. 14-16: Yer done.

Okay, so I lied. You're not done yet. You're *almost* done.

Checkpoint Video #18: <http://youtu.be/P-H-Zq0vl2E>

15 – Assembling & Installing the LCD Panel Mount

For this task, you'll need the following components:

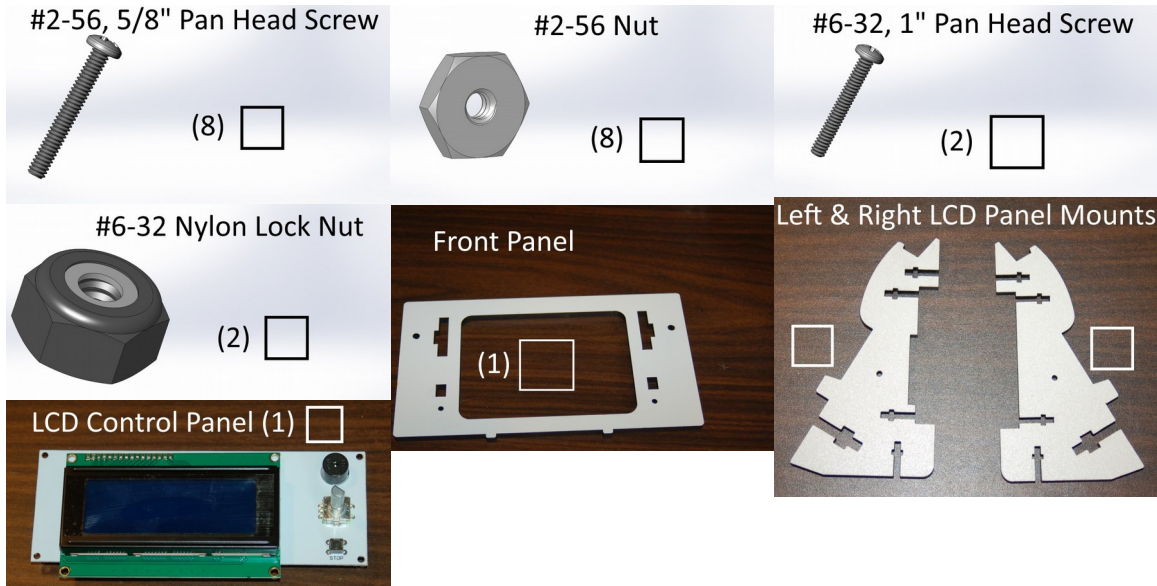

The LCD control panel can be found wrapped in bubble wrap, inside the clear plastic box marked, “LCD Controller”.

Assembling the Front Panel

First up, go ahead and install the #6-32 Nylon lock nuts and the #2-56 finish nuts in the nut pockets on the two LCD mounting brackets.

Keep in mind that the panel mounts come as left and a right part. The left side has a notch cut out to accommodate the SD card reader socket in the LCD panel itself. This notch is highlighted in green in Fig. 15-1.

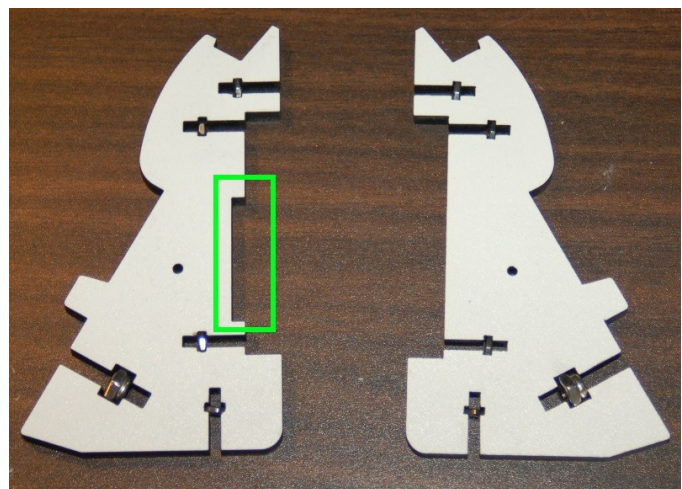

Fig. 15-1: TGIF! (T-Nuts Go In First)

Rostock MAX v2 Assembly Guide

Start with the left side first – the narrow end of the support fits into the front panel as shown below. Make sure that you've got the front panel oriented properly – the tab pointed to by the arrow should be pointing down when the front panel is held vertically.

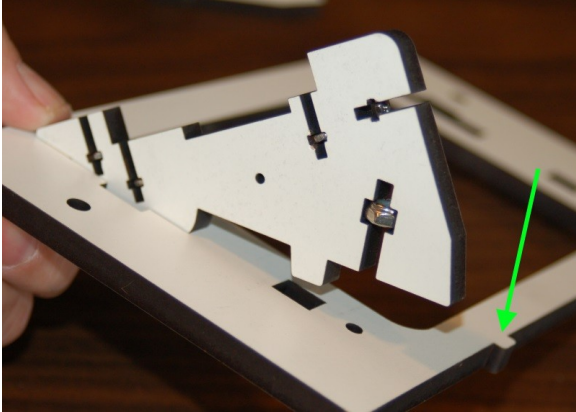

Fig. 15-2: Installing the left side.

Now install the right side and fix it in place.

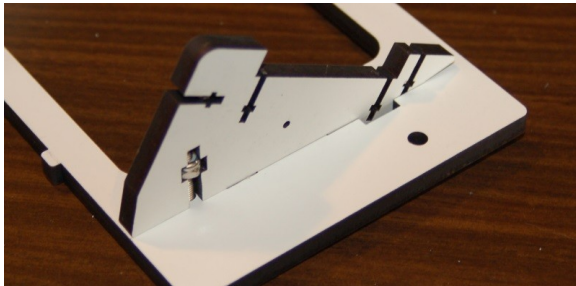

Fig. 15-4: Right side installed.

Press the tab into place until the mount is flush with the face of the front panel as shown. Fix in place with a #6-32 pan head screw.

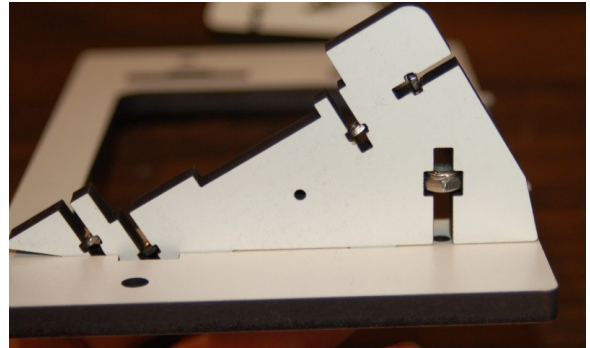

Fig. 15-3: Left side ready for a screw.

Now you can attach the LCD control panel to the mounts. Orient the LCD panel as shown so that the SD card socket matches the notch for it.

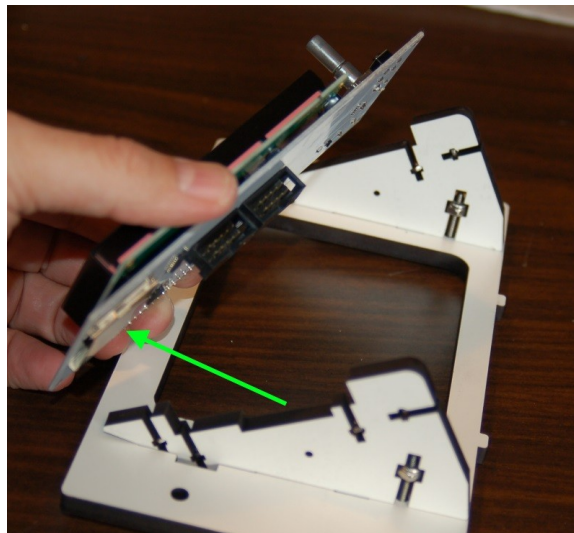

Fig. 15-5: LCD panel orientation.

Rostock MAX v2 Assembly Guide

Attach the LCD panel to the mount using four #2-56, 5/8" screws.

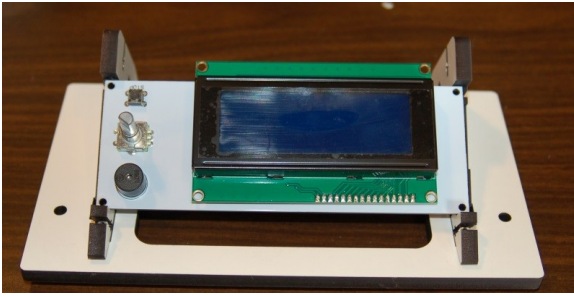

Fig. 15-6: Ready for screws!

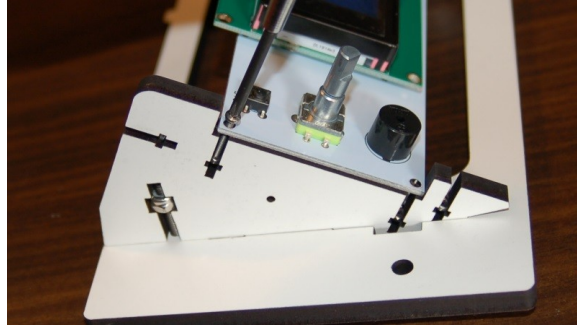

Fig. 15-7: First screw going in.

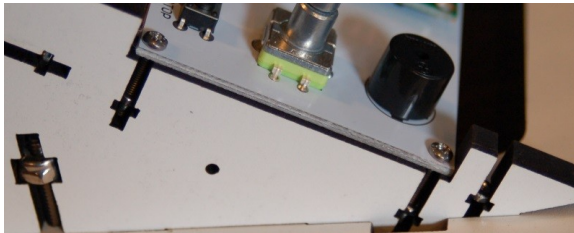

Fig. 15-8: Right side done.

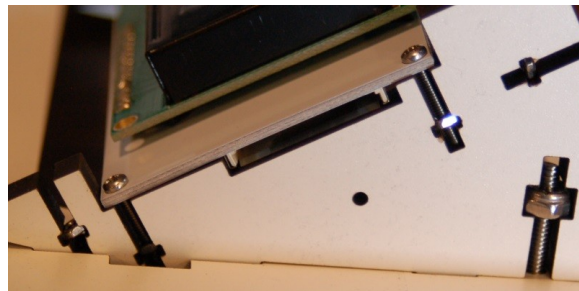
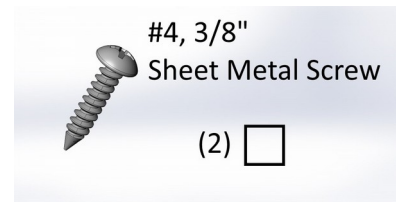
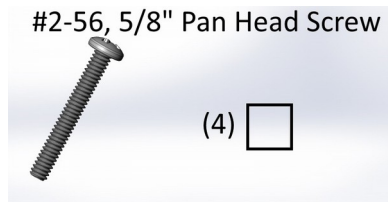
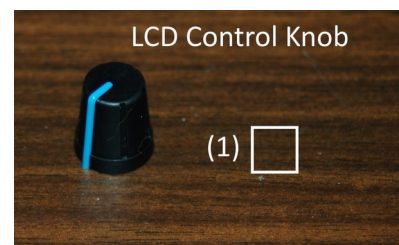
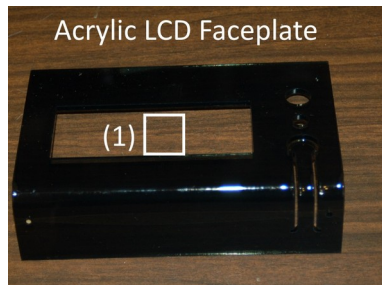
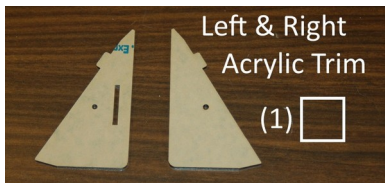

Fig. 15-9: Left side done.

With that done, we can move on to getting the acrylic LCD covers in to place!

Installing the LCD Trim Panels

For this step, you'll need the following components:



Start by peeling the protective cover paper off the left & right acrylic side trim.

Install the left trim piece using a #4, 3/8" sheet metal screw as shown below.

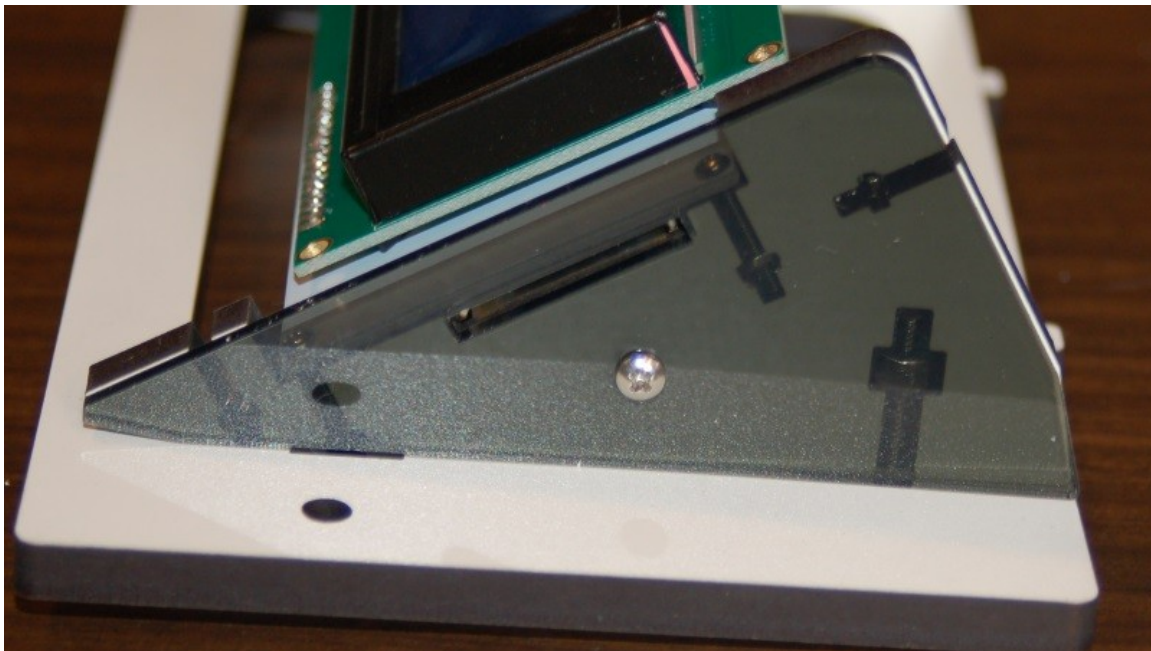

Fig. 15-10: Left side trim installed.

Install the trim on the right side in the same manner as the left.

Set the acrylic face plate over the LCD (it should clear easily) and install two #2-56, 5/8"

Rostock MAX v2 Assembly Guide

screws at the locations shown below. Do not tighten the screws all the way – leave them a few turns loose.



Fig. 15-11: Bottom faceplate screws.

Next, install two more of the #2-56, 5/8" screws at the top front of the faceplate and tighten. Tighten the lower screws at this time. Install the knob last.

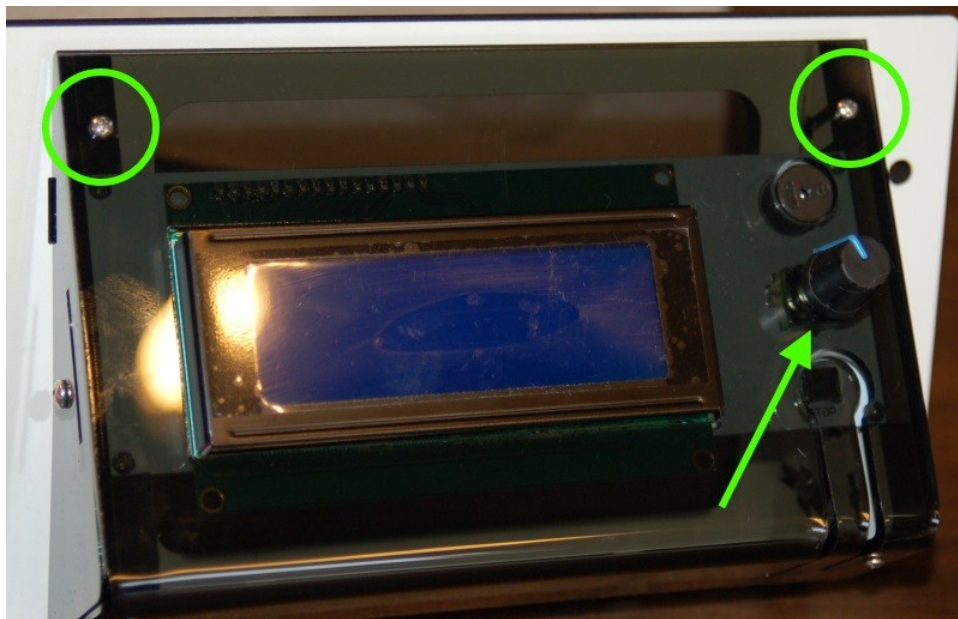

Fig. 15-12: Completed LCD control panel.

Flip the LCD control panel over and mark the EXP1 and EXP2 connector positions as shown below. Use a Sharpie or other permanent marker.

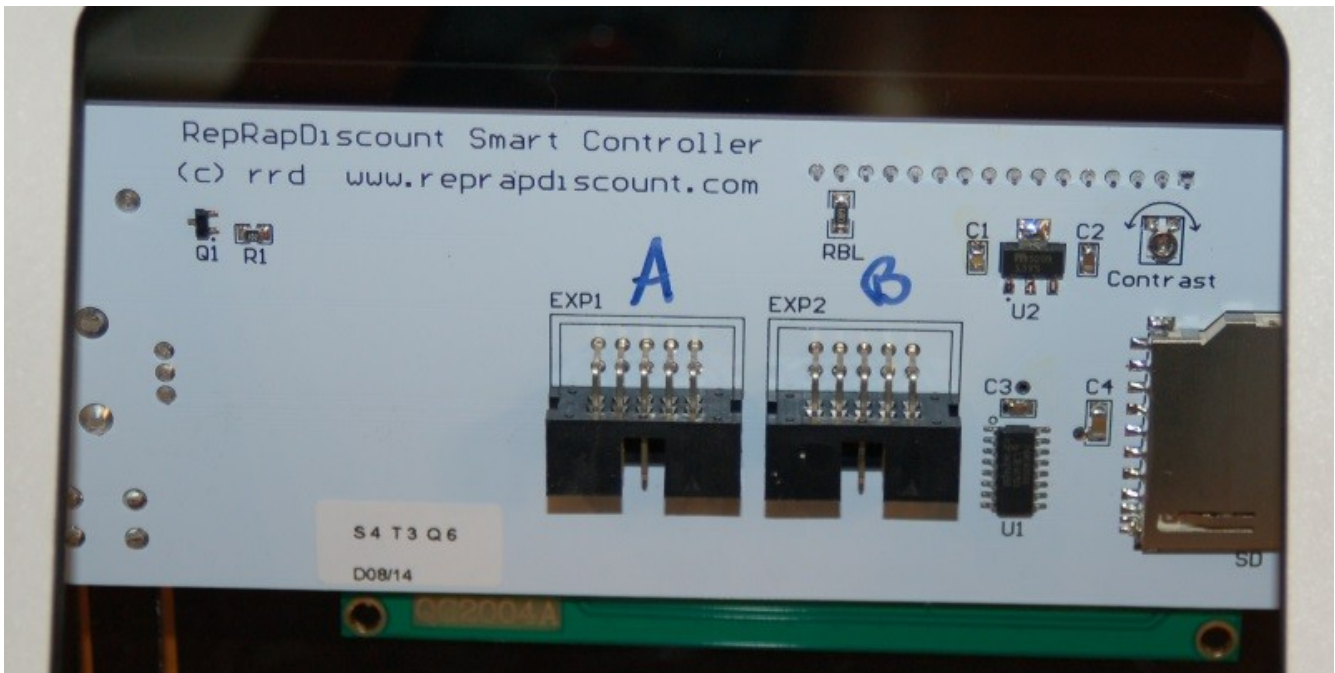

Fig. 15-13: Marked control cable connections.

Put your newly completed LCD controller in a safe place – we'll get back to it soon enough.

You should congratulate yourself at this point – the mechanical assembly of your Rostock MAX v2 kit is complete. Wander off and enjoy \$ADULT_INTOXICANT, kick back and relax for a while. Next on the agenda is the electronics!

Checkpoint Video #19: <http://youtu.be/kFCU8PWTrOk>

16 – Installing & Connecting the RAMBo Controller

Preparing the RAMBo Mounting Plate

For this task, you're going to need the following materials:

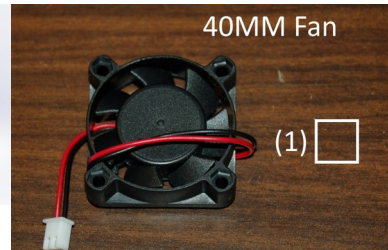
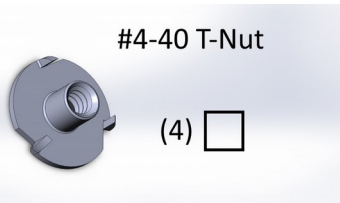
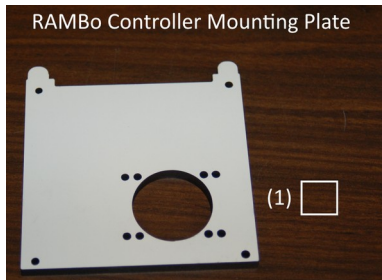

You'll also need two short wire ties in order to attach the fan to the back of the RAMBo mounting plate.

Let's get the 40MM fan attached. Lay the mounting plate on your work surface so that the opening for the fan is on the left edge. Set the 40MM fan over the opening with the blades facing you.

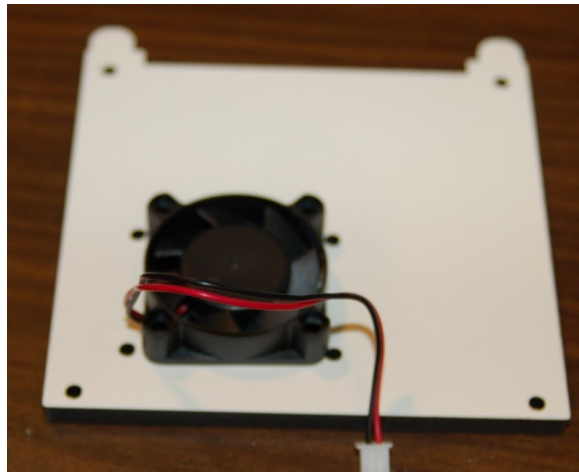

Fig. 16-1: Mount & fan orientation.

Fix the fan in place with two wire ties. First, attach the lower left corner as shown. Try not to capture the power wires when you close the wire tie. :)

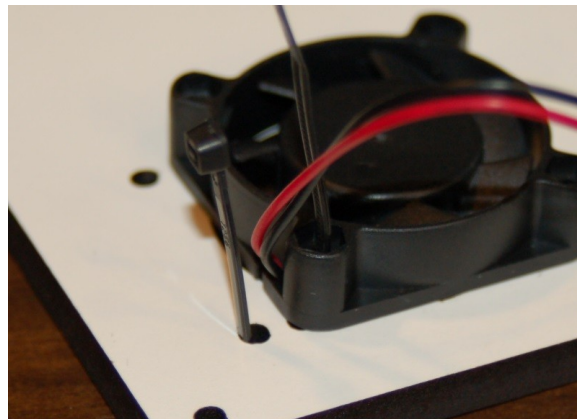

Fig. 16-2: First wire tie location.

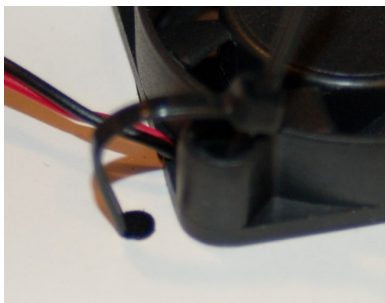

Fig. 16-3: Wire tie closed.

Install the second wire tie in the upper right mounting hole

Rostock MAX v2 Assembly Guide

as shown below.

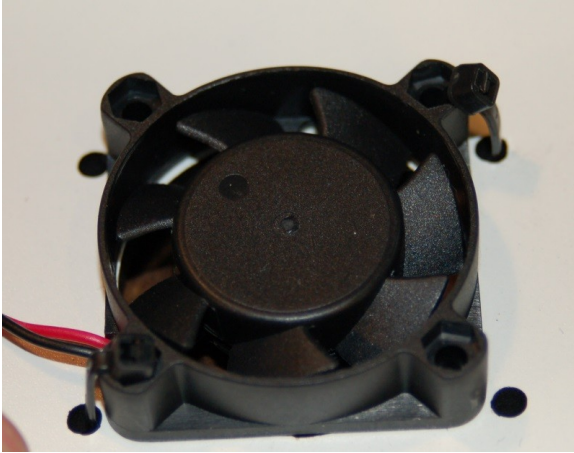

Fig. 16-4: Fan installed.

Now install a #4-40 T-Nut into the four corner holes in the RAMBo mount.

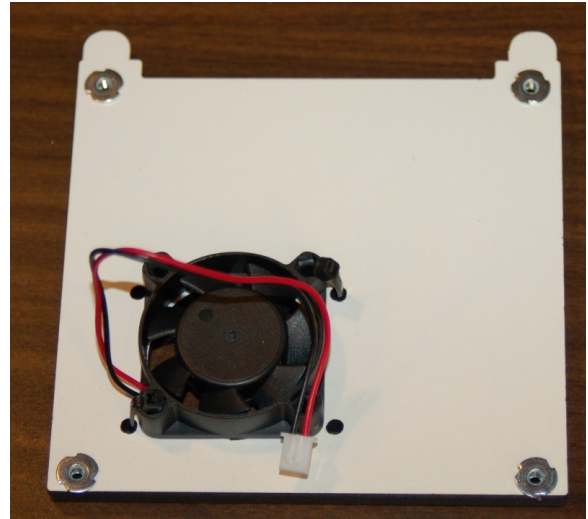
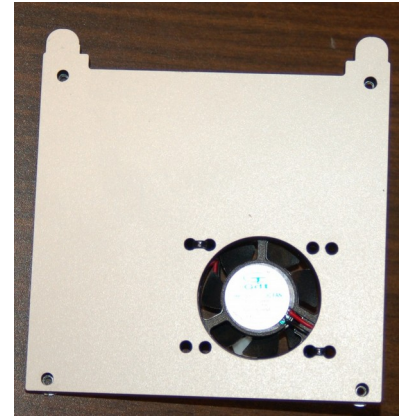
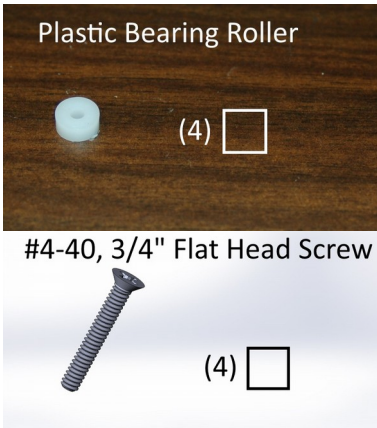
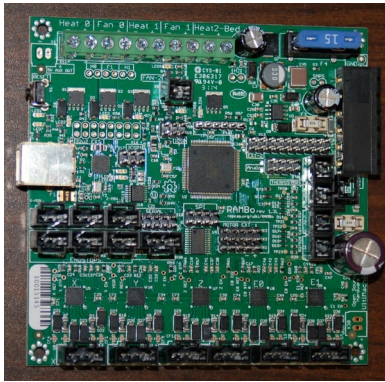

Fig. 16-5: T-Nuts installed.

Mounting the RAMBo Controller

For this task, you'll need the following components:



The first thing you'll need to do is get the 40MM fan wires soldered to the RAMBo controller. Start by cutting off the connector at the end of the fan leads and strip off about 1/8" of insulation.

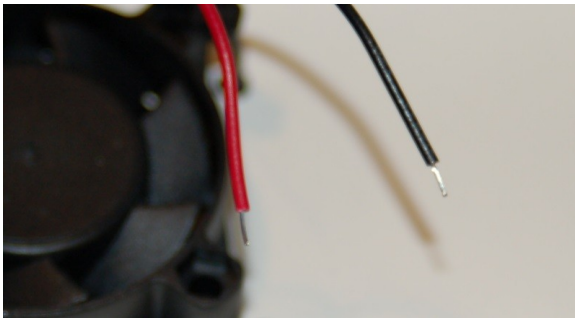

Fig. 16-6: Fan leads stripped.

Make sure that you install the wires as shown – the red wire needs to be in the pad marked with the “+” next to it. If you install it the other way, the fan may run in reverse and won't cool the MOSFET chips on the RAMBo very well. (The MOSFETs are those little black squares in the photo in Fig. 16-7.)

Get your soldering iron heating and insert the ends of the fan wires into the two solder pads on the bottom right hand corner of the RAMBo controller as shown.

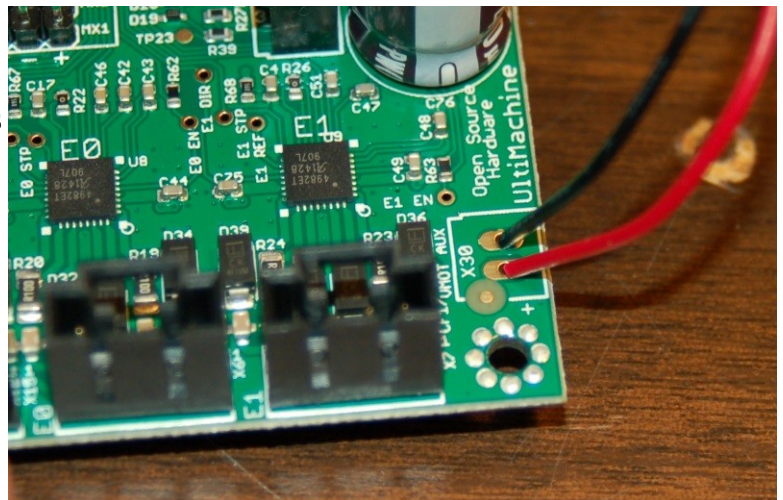

Fig. 16-7: Fan wire installation location.

Rostock MAX v2 Assembly Guide

Hold or tape the wires into place and flip the RAMBo controller upside down so you can reach the solder pads on the back side of the board. Solder the leads in place.

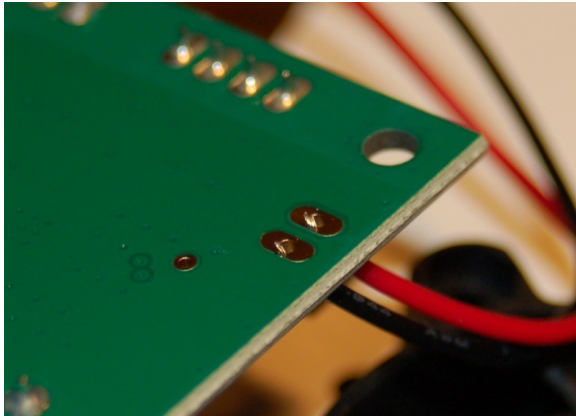

Fig. 16-8: Fan power solder pads.

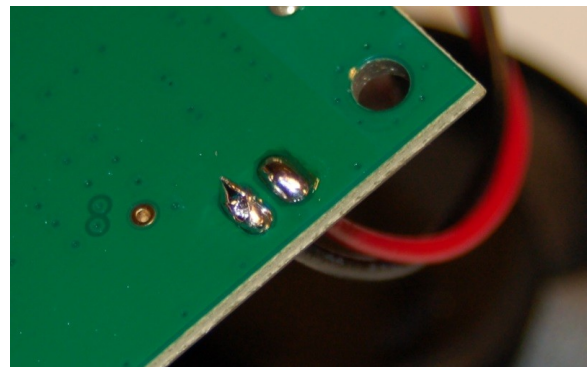

Fig. 16-9: All done.

Mounting the RAMBo is very straightforward. Simply set the RAMBo on top of the mount and slide a plastic roller between the RAMBo and the mounting plate as shown in Fig. 16-10. Insert a #4-40, 3/4" flat head screw in the hole and tighten a few turns.

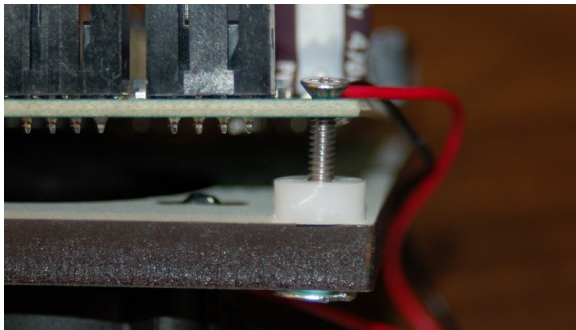

Fig. 16-10: Starting the screw.

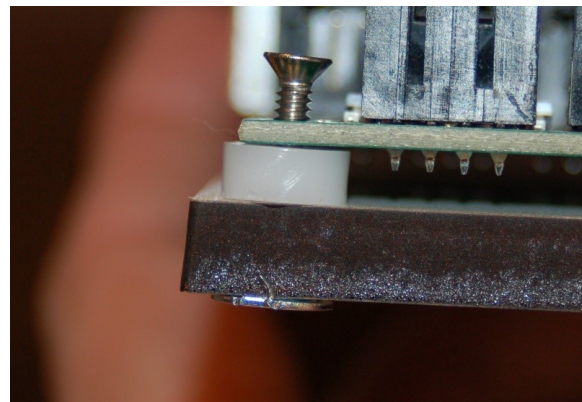

Fig. 16-11: Same idea, different screw.

When you've got all four screws started, go ahead and tighten them all down. Take care to not over tighten them or you'll damage the circuit board!

Checkpoint Video #20:

<http://youtu.be/JrmqtoH2MQ4>

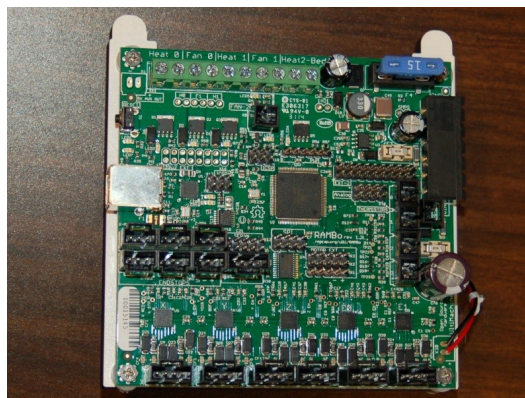
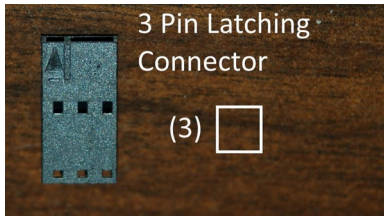

Fig. 16-12: Done!

Wire Prep: End Stops

For this task, you'll need the following components:



The 3 pin latching connectors can be found inside the RAMBo parts baggie (marked “RAMBo v1.3 Kit” or similar).

The end stop wires came with female crimp connectors already attached. Each connector has a tiny little metal tab that points slightly away from the connector itself. This metal tab engages a little hole in the middle of each connector position on the 3 pin latching connector shell.

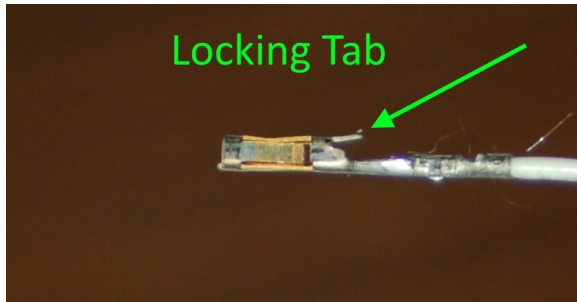

Fig. 16-13: Female crimp connector.

Insert the white wire from the X axis end stop into the pin #1 position on the connector as shown. Make sure that the locking tab is oriented in line with the locking tab retaining hole. You'll hear a soft “click” sound when the tab engages the hole. At that point, the connector is fully seated.

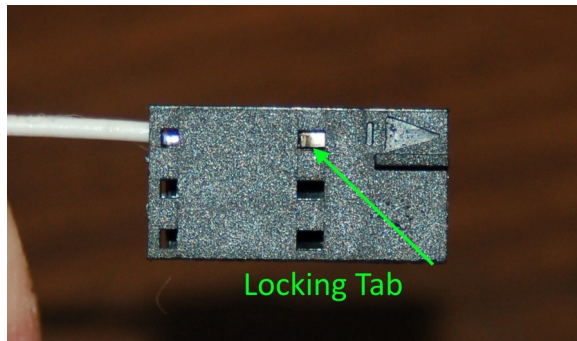

Fig. 16-15: Connector fully seated.

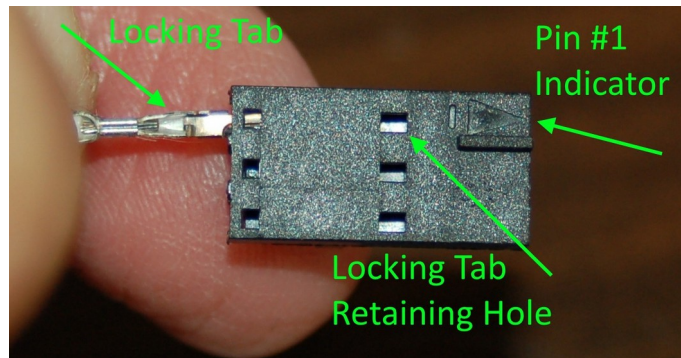

Fig. 16-14: Setting the first connection.

Insert the black wire from the X axis end stop into the second position, right below the first. Repeat this task for the Y and Z axis end stops.

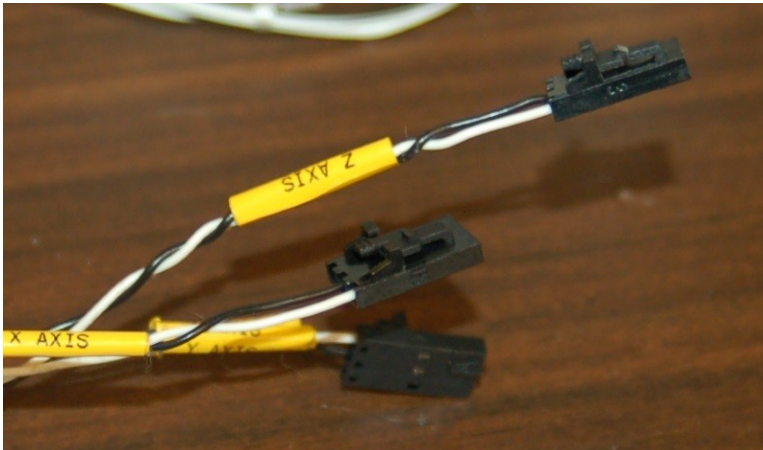

Fig. 16-16: Finished end stop connectors.

You'll want to bundle up the end-stop wires similarly to how I've done on the right. The X axis end-stop wire should be looped up a little to take up the extra wire it has.

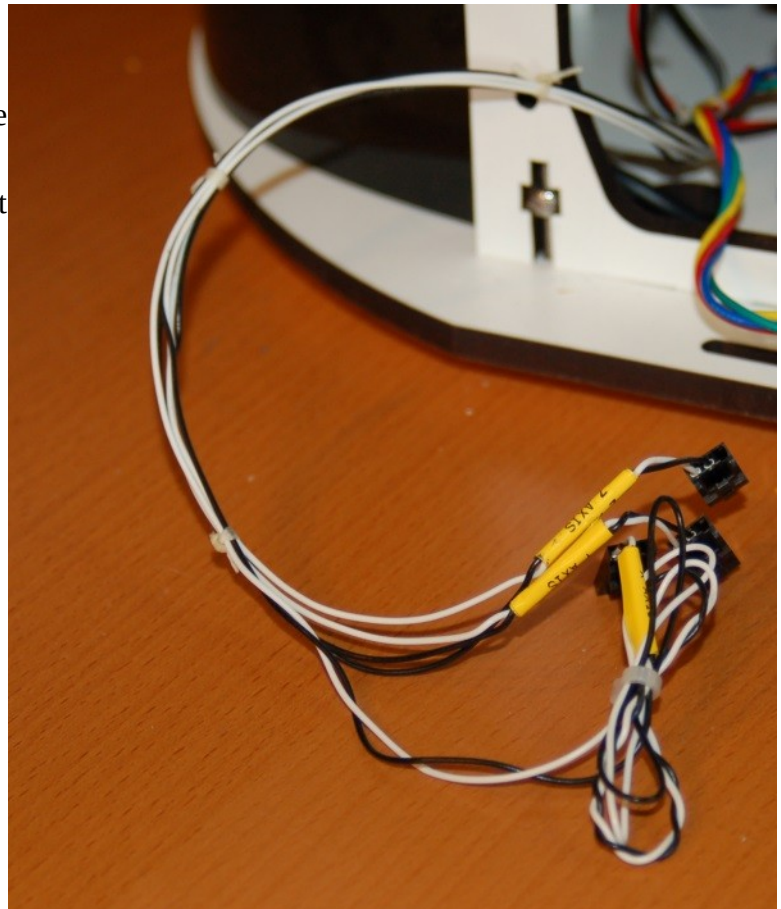

Fig. 16-17: End-Stop wires bundled, with connectors attached.

Wire Prep: The Hot End Thermistor Connector

For this task, you'll need the following materials:



Thermistor leads.

Unwrap the thermistor leads you got from the RAMBo box and cut them so you've got about 3" of wire after the 2 pin connector.



Fig. 16-19: Thermistor leads cut to length.

The thermistor leads can be found inside RAMBo parts baggie (marked "RAMBo v1.3 Kit" or similar).

The first thing you'll need to do is trim the hot end thermistor and hot end power wires to their working length. You want about 8" of wire as measured from the front edge of the machine.

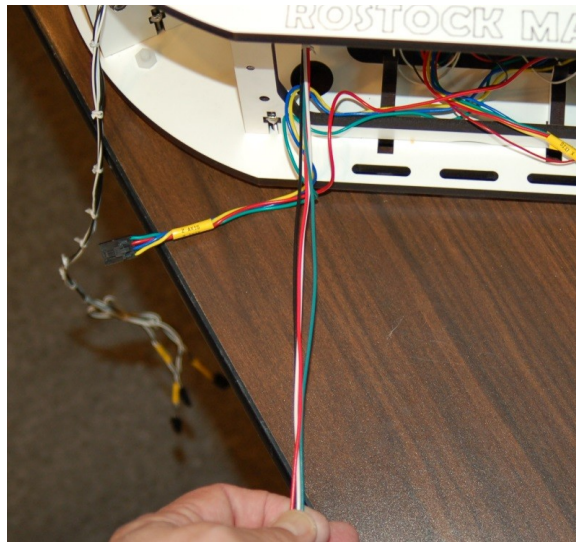
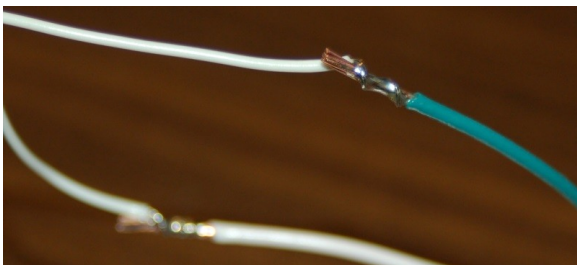

Fig. 16-18: Working length for hot end & thermistor wires.

Solder the shortened thermistor leads to the 18ga white & green wires. We're doing this because the crimp connectors aren't designed to handle 18ga wire.



When you're done, cover the solder joints with Kapton tape and label the leads, "T0 HOT END THERMISTOR" (That's a "T" followed by a zero.)



Thermistor leads finished & labeled.

Wire Prep: The Heated End Thermistor Connector

The Onyx heated bed wiring doesn't require a connector to be added, but you should label the wire and loop up the extra. Label the end of the wire "T2 BED THERMISTOR" I'm using a Brady IDPal label tool for my wiring, but a bit of masking tape does the same job. :)

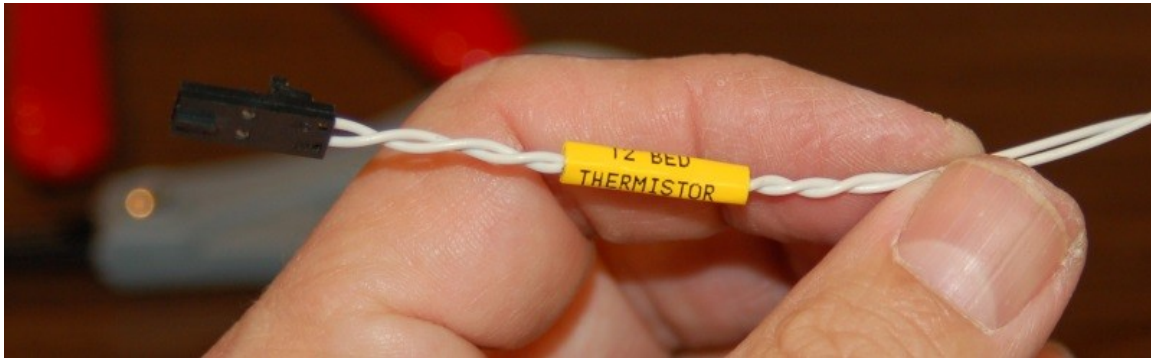

Fig. 16-22: Bed thermistor lead labeled.

Now loop up the extra wire from the bed thermistor lead. You only need about 6-8" of wire sticking out the front of the machine to have enough slack to work with later on. **Do not cut the wire to shorten it.**



Fig. 16-23: Bed thermistor wire bundled up

Wire Prep: Extruder Motor Connector

For this task, you'll need the following components:

Rostock MAX v2 Assembly Guide



The 4 pin latching connector and crimp sockets are found inside RAMBo parts baggie (marked “RAMBo v1.3 Kit” or similar).

This task requires that you crimp four crimp sockets on to the leads coming out of the Y tower from the extruder. Please refer to the notes about wire crimping in the Introduction.

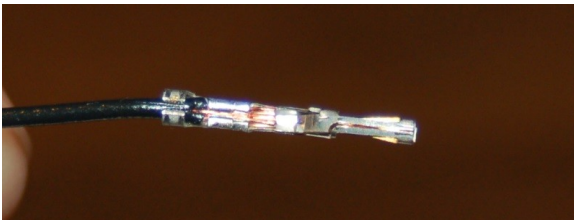

Crimp a female socket on to each of the four 22ga extruder extension wires.

The 4 pin latching connector body has an arrow that marks the #1 pin (the same marking as the one you saw on the thermistor connector).

Fig. 16-24: First of four crimps.

Insert the wires into the connector shell in the order shown in Fig. 16-25. (green, red, black, white)

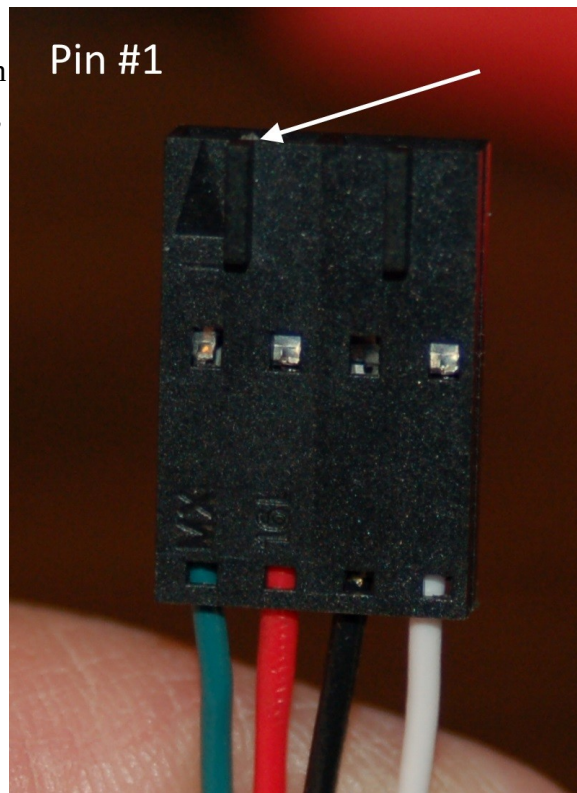

Fig. 16-25: Connector wire order.

Wiring the RAMBo Controller – Terminal Block

Note that all wiring should be brought through the center opening in the front vertical support!

Rostock MAX v2 Assembly Guide

First up, let's get the hot end resistors connected to the RAMBo. Bring the wires forward so they exit the front opening of the printer and trim them so there is 6" of wire extending past the outside edge of the machine. You'll be trimming the other "bare" wires to this length as well, but not yet.

Strip 1/4" off the black & red 18ga wires that come from the hot end. Insert them into the **Heat 0** connector as shown below. Note that the black wire goes into the side with the "-" above it, and the red wire goes into the side with the "+" above it. Tighten the screws for these two points on the terminal block. **DO NOT, UNDER ANY CIRCUMSTANCES "TIN" THE LEADS GOING INTO THE TERMINAL BLOCKS! DOING SO CAN CREATE AN INTERMITTENT OR HIGH-RESISTANCE CONNECTION THAT COULD BECOME A FIRE HAZARD!**

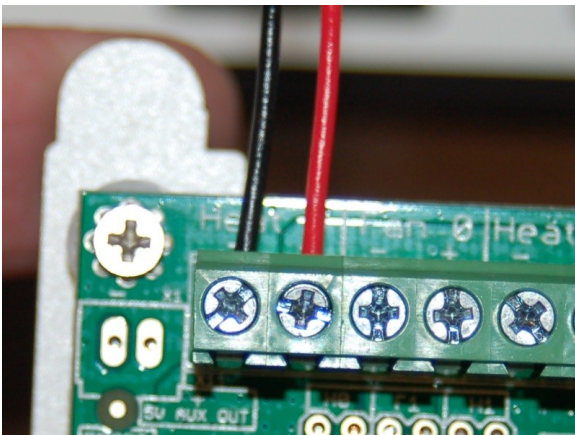

Fig. 16-26: Hot end wires installed.

Next up is – yep, the PEEK fan wires. This is the pair of 26ga wires *with* the knot in them. The PEEK fan wires are installed in the terminal block at the location marked "**Heat 1**". You may want to label this wire pair, "**PEEK Fan**" before you install them.

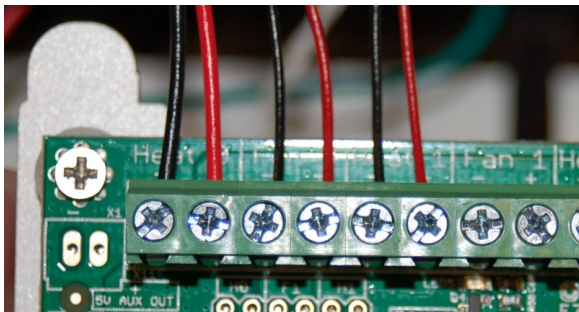

Fig. 16-28: PEEK fan wires installed.

The next pair of wires to be installed are the layer fan wires. These are the black & red, 26ga wires that do *not* have the knot tied in them. The layer fan wires should be inserted into the terminal block position marked "**Fan 0**". Strip 1/4" of insulation off them and install them. You might want to label this pair "**Layer Fan**" so that you can readily tell them apart from the peek fan wires that you'll install next.

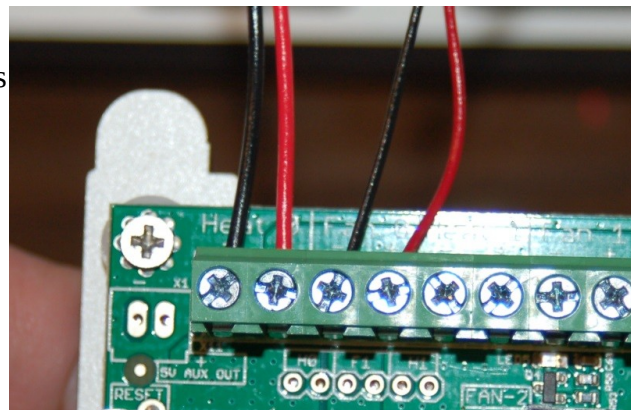

Fig. 16-27: Layer fan wires installed.

A quick note about the PEEK fan wiring. The firmware used on the RAMBo is configured to use a single hot end. Because of this, the **Heat 1** terminal block position will automatically turn on the PEEK fan when the hot end is first heated and

will automatically turn off when the hot end temperature falls below 50C. At some point in the future, you may want to install a second hot end. If you do this, you'll need to modify the firmware so you can use the **Heat 1** output for a hot end and the **Fan 1** output for one or more PEEK fans.

The last terminal connection you're going to make is for the Onyx heated bed. Like you did with the other wiring, strip 1/4" off the wires. Insert the heated bed wires into the terminal block at the position marked "**Heat2-Bed**" as shown below in Fig. 16-29.

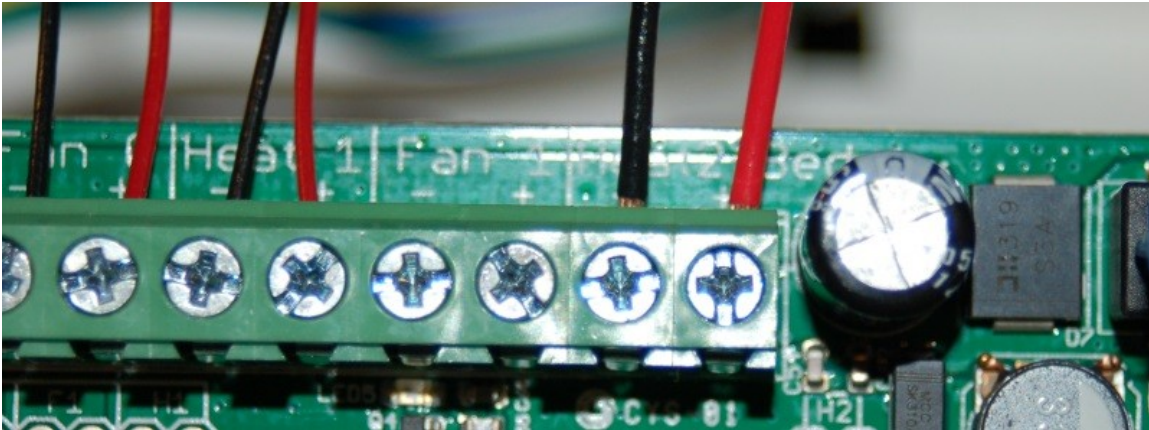

Fig. 16-29: Heated bed wires installed.

Plugging cabling into the RAMBo

Now we're going to plug in the end-stop connectors, the stepper motors, the thermistors and finally the main power connector. I'll keep the photos big so detail is easy to see.

First, let's get the end stop wires plugged in.

Insert each of the three end-stop connectors into the sockets shown below. I've labeled each position in Fig. 16-30 as the board silk screen can be difficult to read due to its small size.

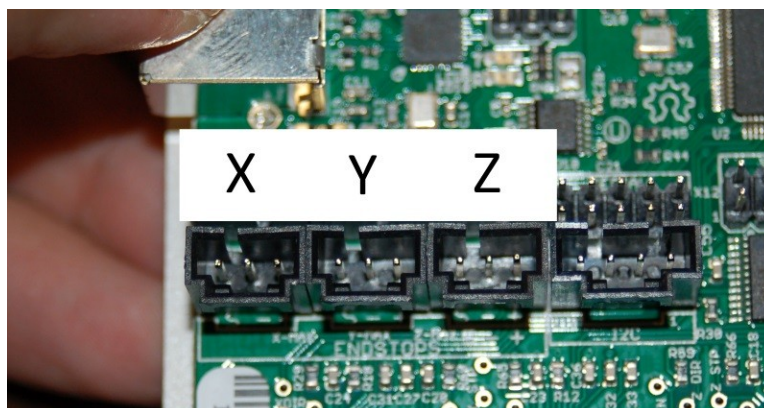

Fig. 16-30: End stop connector plugs.

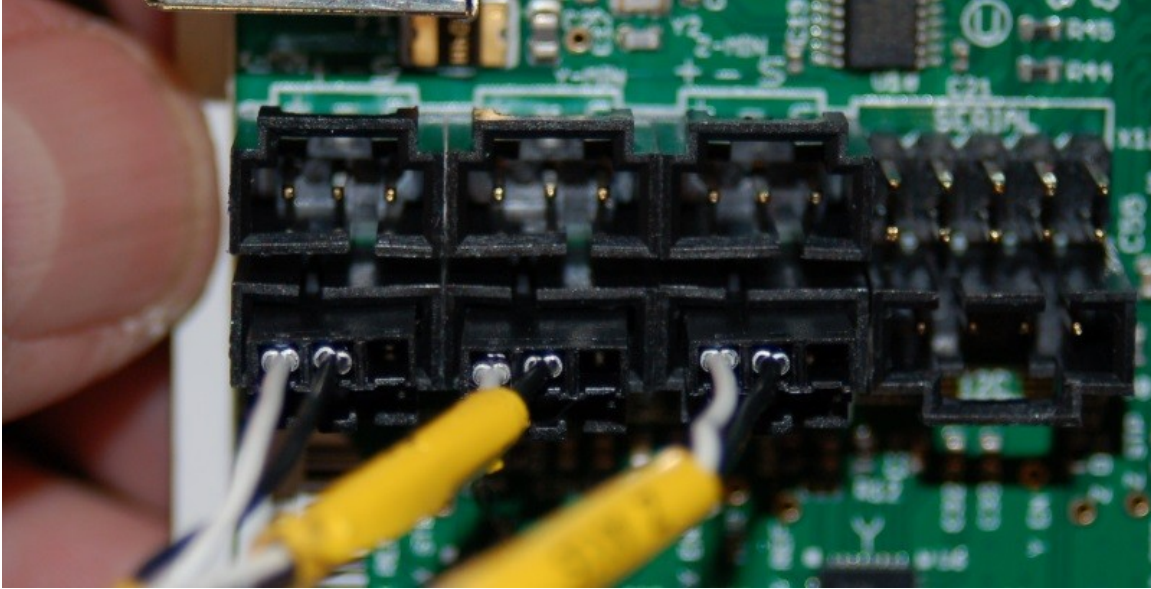

Fig. 16-31: End stops plugged in.

Now you can install the thermistor connectors. Remember how I had you label the thermistor leads with “T0” and “T2”? Well there was a method to that particular madness. The thermistor positions on the RAMBo are marked T0 through T3. By labeling them ahead of time, it eliminates any confusion about which is which and you won't have to refer to the manual to see who does what. :)

I've marked the T0 and T2 positions for you, so go ahead and get the thermistors plugged in!

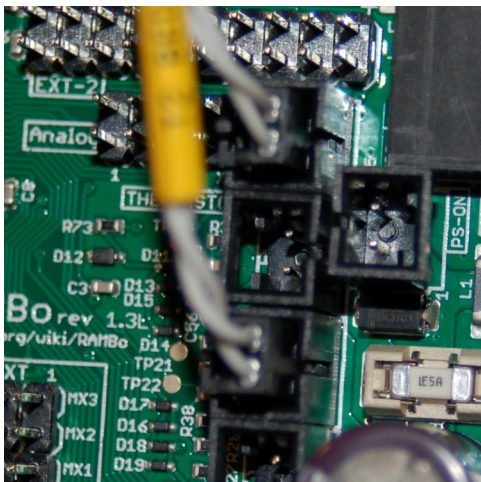

Fig. 16-33: Thermistors plugged in.

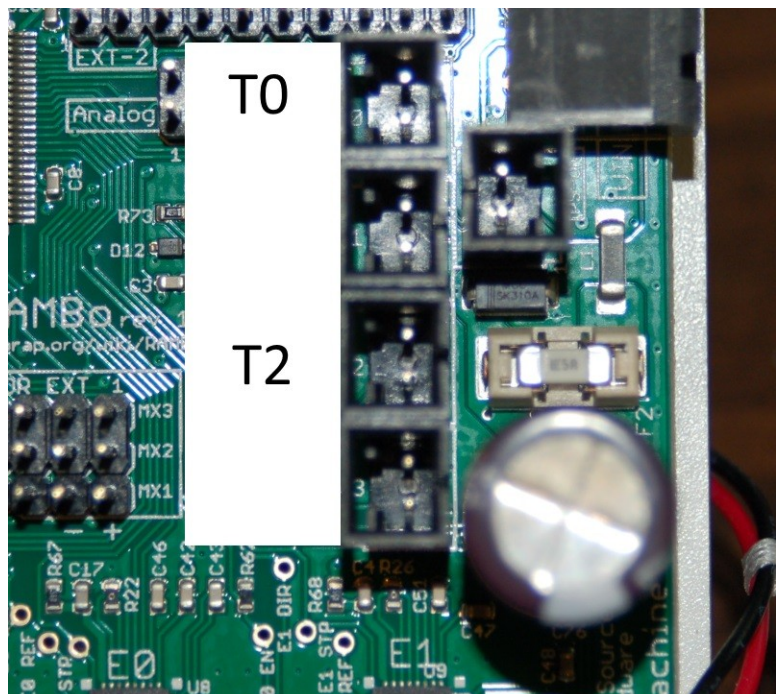

Fig. 16-32: Thermistor connectors.

Rostock MAX v2 Assembly Guide

Now bring out the stepper motor wires and connect them into the motor plugs along the bottom edge of the RAMBo controller. Each axis is labeled – make sure you match them up! The position marked “E” below is where the extruder connects to.

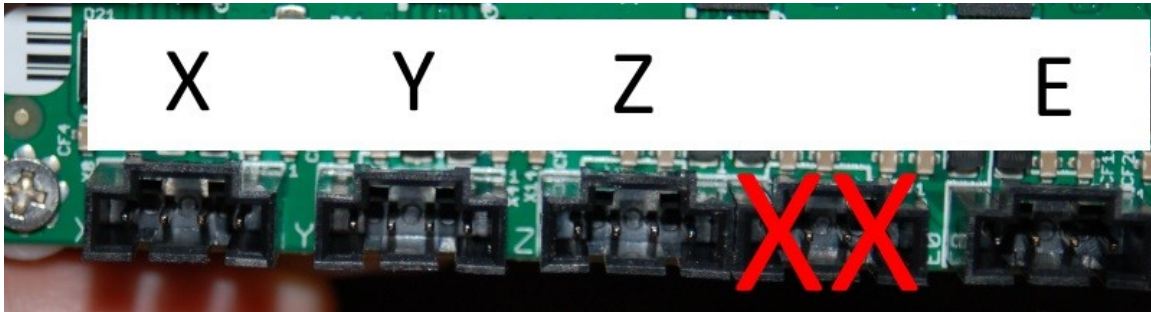

Fig. 16-34: Stepper motor connectors.

You'll notice I've marked one of the connectors with a double red “X”. This is because this connector is for an extra Z axis. Delta configuration printers don't require this – I pointed it out to ensure you didn't accidentally plug the extruder into it...like I did. ***ahem***

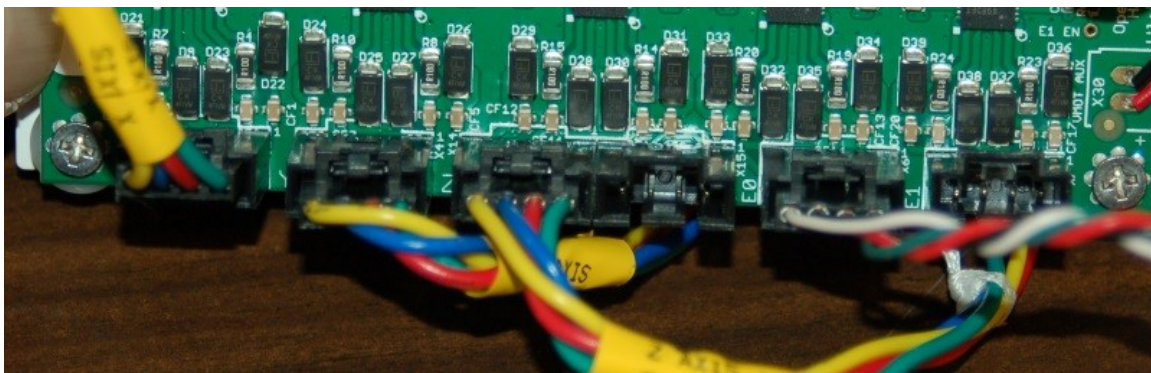

Fig. 16-35: Stepper motors plugged in.

Just a quick note on the stepper motor connectors. The connectors you see in Fig. 16-35 are 4 pin latching connectors. That means they've got a little locking tab that positively engages a little ledge on the inside of the socket that's on the RAMBo. Sometimes SeeMeCNC has to procure stepper motors from a secondary source. These motors don't have the locking tab feature.

The connector will work just as well as the locking version, but does look different and can be accidentally inserted backwards. The pin indicated by the arrow in the Fig. 16-35.5 is pin #1. This pin is on the right edge of the connector when you plug it in to the RAMBo. **These motors are made by Kysan or Automation Technology and are just a little bit different**

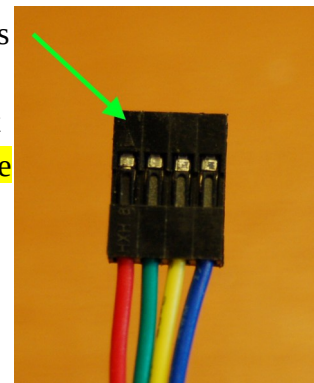

Fig. 16-35. Alternate connector style.

from the “stock” motors. Later on we’ll be making a change to the firmware to account for this difference.

Finally, you’ll need to plug the big power connector into the side of the RAMBo as shown below.

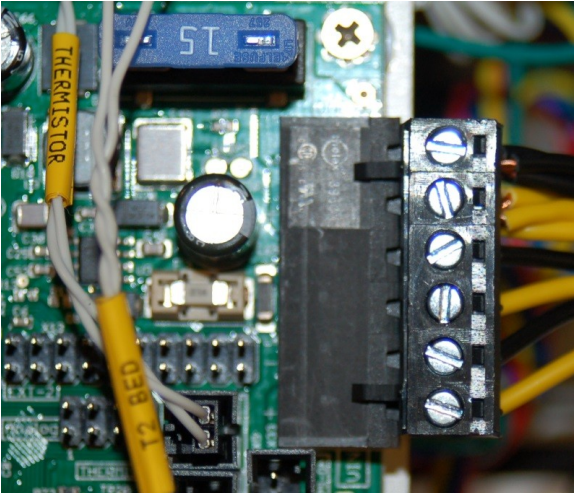

Fig. 16-36: Power connector attached.

Installing the RAMBo Into The Machine Base

Now the RAMBo board can be installed into the base of the printer.

The RAMBo mounting plate has two curved tabs that fit into slots located on the top plate of the base. When installed correctly, the tabs will fit into those notches and the base of the RAMBo mount will rest on the two support legs that you installed when you were building the base.

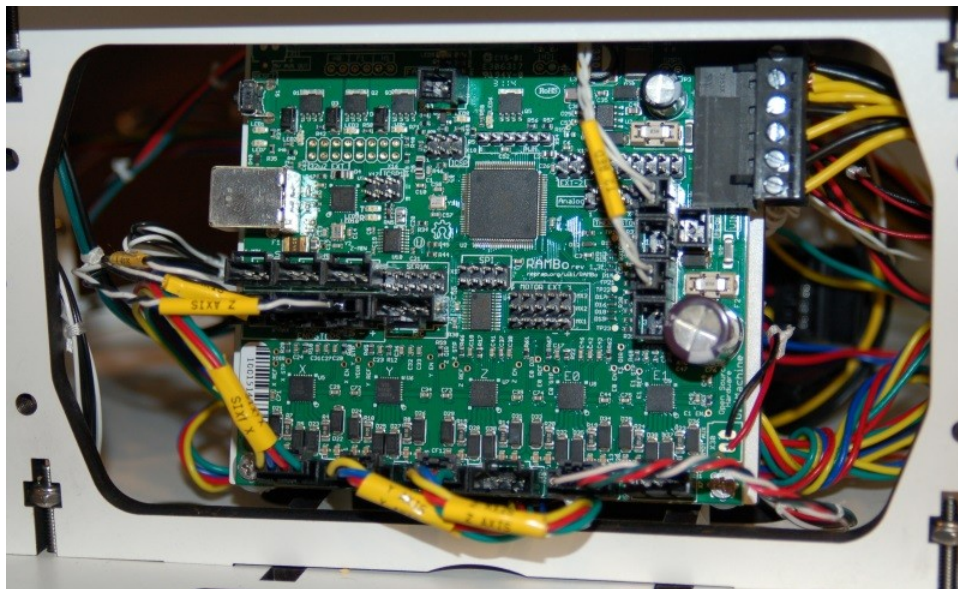

Fig. 16-37: RAMBo installed!



Fig. 16-38: Right slot.

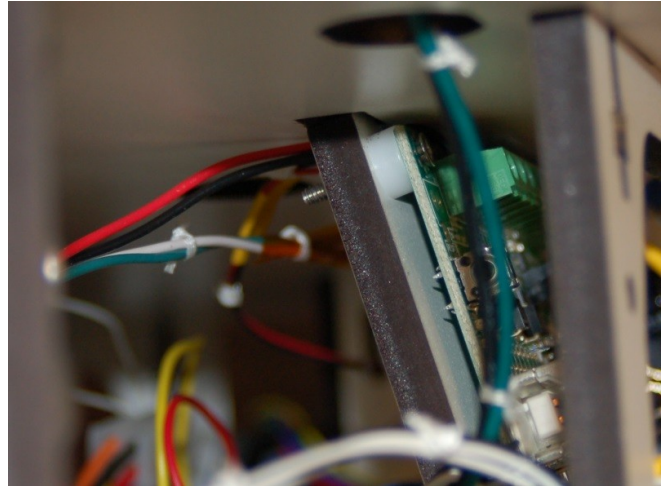

Fig. 16-39: Left slot.

Once you've got the two tabs on the top of the RAMBo mounting plate fitted into the two slots, you can lift up and the mount will slide into place along the two support legs. The X, Y and Z stepper motor wires can be routed directly under the board – there *is* room. Take care to not pinch a wire between the bottom of the RAMBo mount and one of the support legs. The extruder stepper wire can be routed to the right if you don't want to run it under the board.

Installing the Power Switch and LCD Controller Cables

In the plastic box the LCD panel came in, you'll find two gray, flat ribbon cables and a small circuit board marked “RAMBo to SmartController adapter”. These cables connect the LCD to the RAMBo controller via the LCD interface board.

Label the adapter board's two 10 pin connectors as “A” and “B” as shown below.

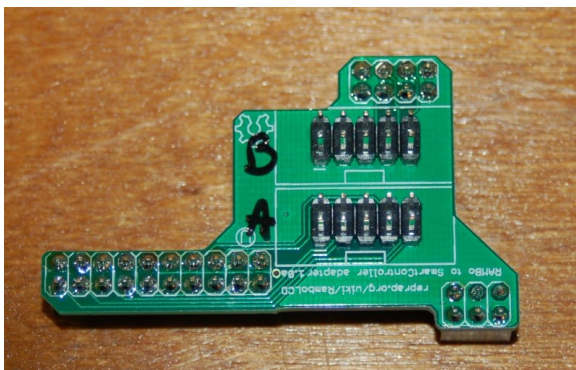

Fig. 16-40: Adapter labeled.

Next, label the two cables with “A” on both ends of one and “B” on both ends of the other.



Fig. 16-41: Cables labeled.

Rostock MAX v2 Assembly Guide

Install the ribbon cables on the LCD interface board as shown below.

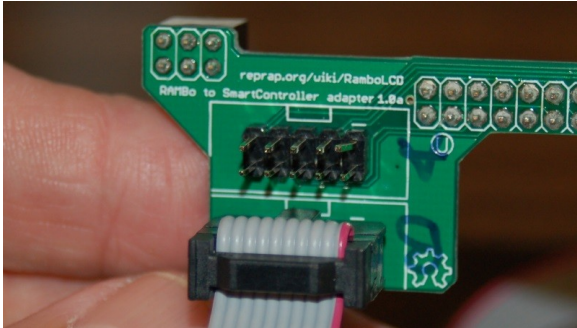

Fig. 16-42: "B" Cable installed.

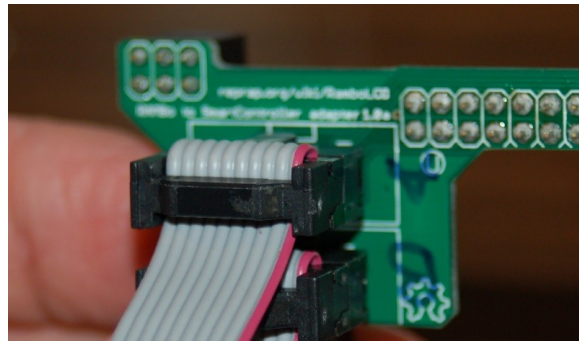

Fig. 16-43: "A" Cable installed.

Install the LCD interface board on to the RAMBo controller as shown. Wiring has been omitted for clarity.

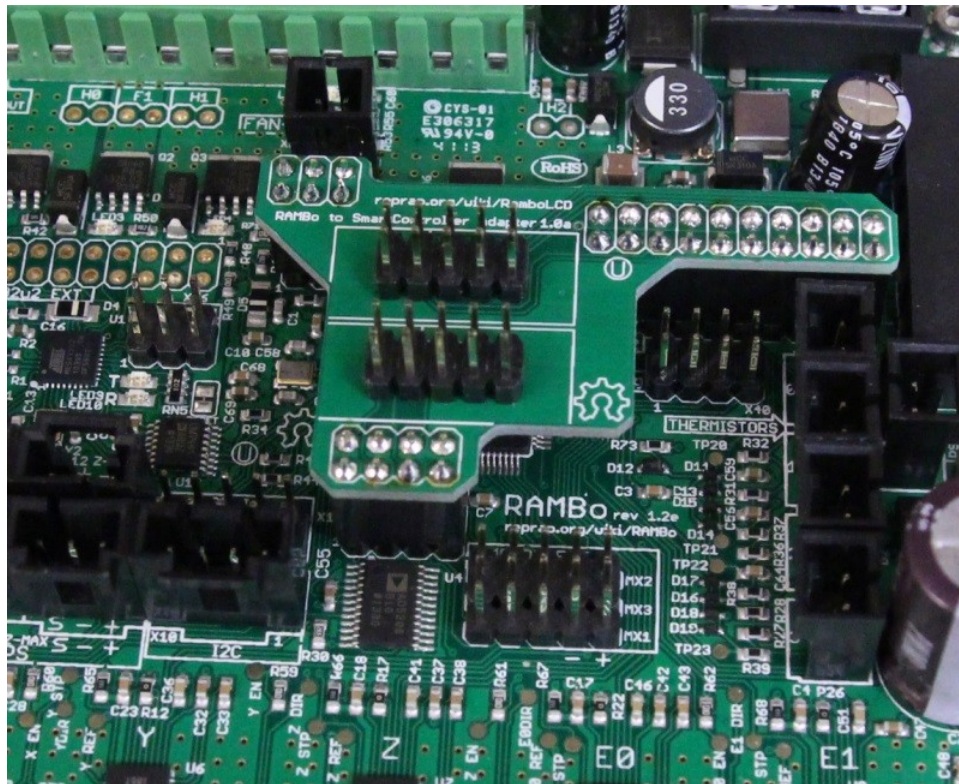

Fig. 16-44: LCD interface adapter installed.

Rostock MAX v2 Assembly Guide

Make sure that the interface adapter board is properly seated on the RAMBo board – it is possible to set the board down offset one row to the left or right and the LCD will not function.

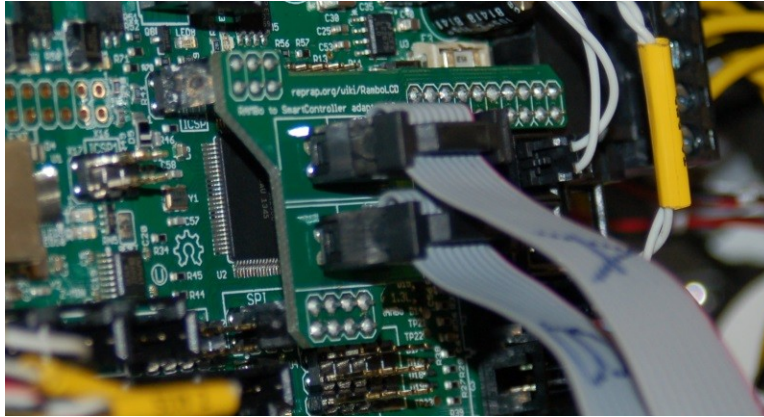

Fig. 16-45: Adapter with cables attached.

Your last task for this chapter will be to install the power switch. You'll of course need the power switch to install it. :)



Fig. 16-46: The Power Switch.

Remove the plastic nut from the power switch and route the black & green wires from the power supply through the nut and then up through the hole in the top plate. Attach the spade connectors to the switch as shown in Fig. 16-48.

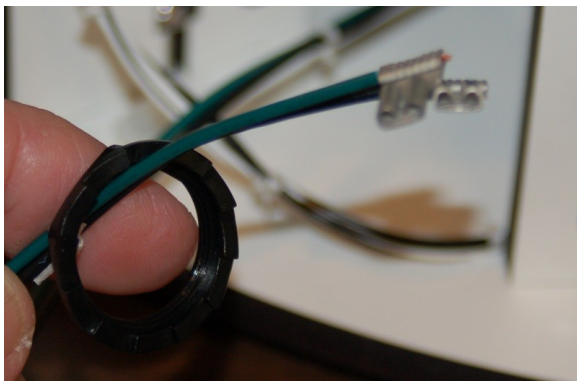

Fig. 16-47: Nut over the power leads.

Make sure that you keep the power switch in the

“off” position. This is shown below.



Fig. 16-48: Ready to install.

Finally, insert the switch into the mounting hole and install & tighten the plastic nut you threaded on to the power wires previously.

Checkpoint Video #21:

<http://youtu.be/UGjHWfnrtKE>

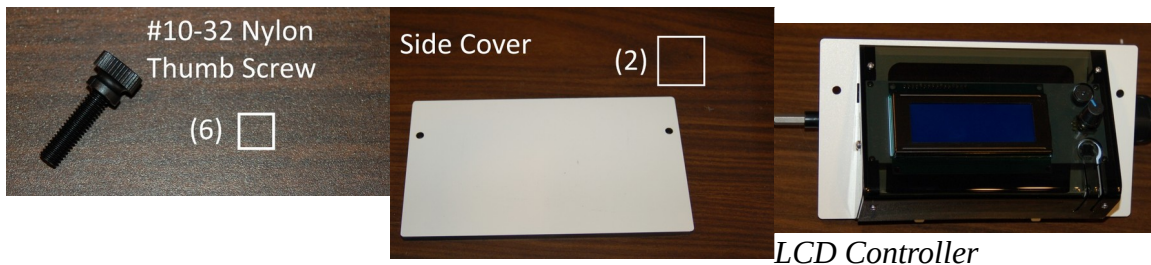

Fig. 16-49: Power switch installed.

17 – Final Assembly Tasks

Attaching the Base Covers & LCD Panel

For this task, you'll need the following components:



Remember back when you built the base, I had you tap the two “top” holes in each vertical support? Now you get to use them! Install a side cover plate on the “back” sides of the Rostock MAX v2 – between the X and Z and Y and Z axes. Use two #10-32 nylon thumbscrews on each one.



Fig. 17-1: Cover plate installed.

Now install the “A” and “B” cables on to the back of the LCD controller in the locations you labeled when you first assembled it.

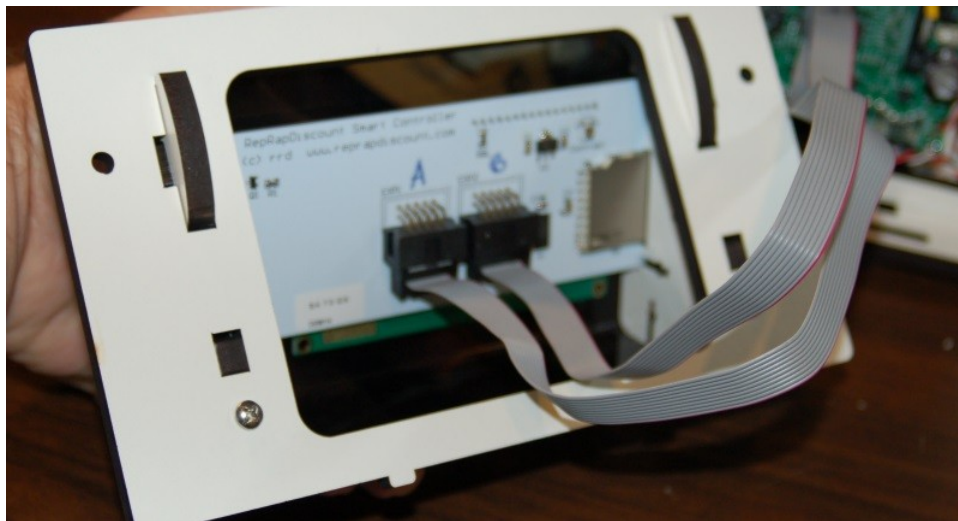

Fig. 17-2: LCD controller cables installed.

You'll notice two small tabs on the bottom edge of the LCD controller assembly. Those tabs fit a pair of slots in the center vertical support. Coil up the controller cables in the space at the bottom of the LCD controller and fit it to the front of the machine as shown.



Fig. 17-3: LCD controller being installed.

Now tilt up the panel and fix it in place using two #10-32 nylon thumbscrews.



Fig: 17-4: LCD panel installed!

Attaching the Power and USB Cables

As shipped, the power supply is set for 115V. If you're in Europe or another country that uses 240V, you'll need to flip the source voltage switch on the power supply so that it reads "240" instead of "115". Fig. 17.5 below shows the switch configured for US power.

Rostock MAX v2 Assembly Guide



Fig. 17-5: Source voltage switch.

Note that if the switch is set for 115V and you feed it 240, you can expect the rapid, unscheduled dis-assembly of certain critical electronic components inside the power supply. This will likely be accompanied a loud noise and a puff of magic smoke as its released.

Route the power cord through the bottom of the machine and insert it into the back of the power supply as shown.

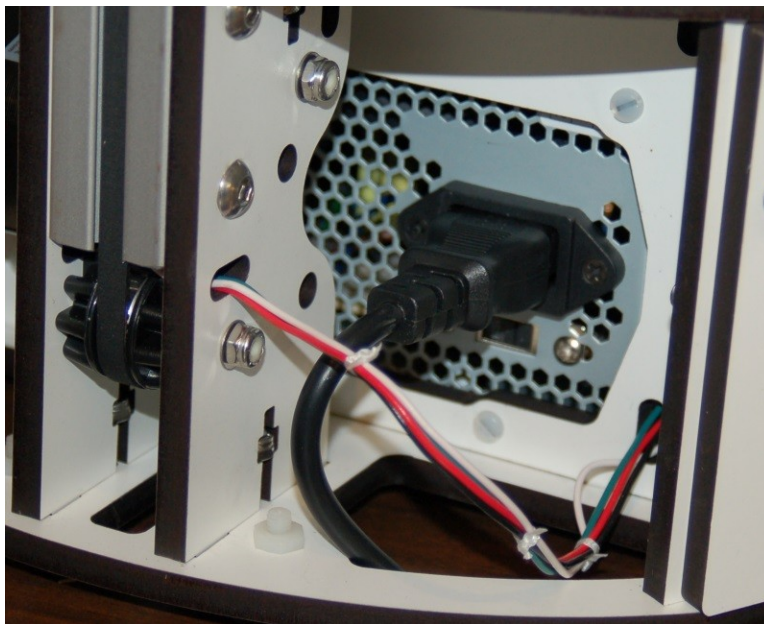

Fig. 17-6: Power cord installed.

Route the USB cable up through the hole in the front of the machine and install it into the RAMBo as shown:

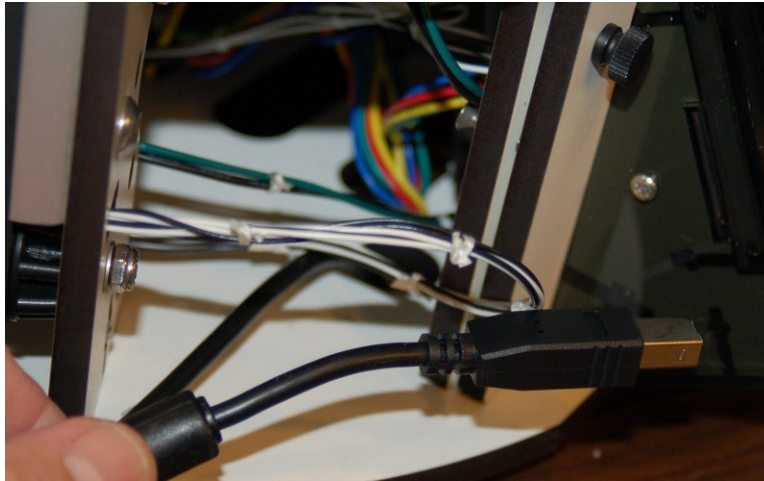

Fig. 17-7: USB cable routed up through the bottom...

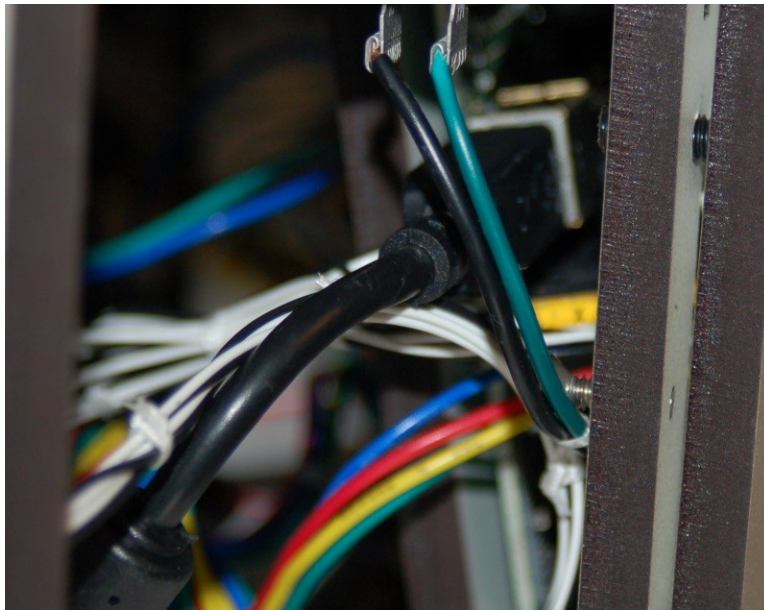

Fig. 17-8: ...and inserted into the RAMBo.

After you've got the USB cable installed, I want you to inspect all the wiring and belt paths to ensure that there's no interference between the wiring and the belts – make sure the belt paths are clear and no wiring is rubbing against a belt.

Installing the Acrylic Cover Panels

For this task, you'll need the following components:

Rostock MAX v2 Assembly Guide

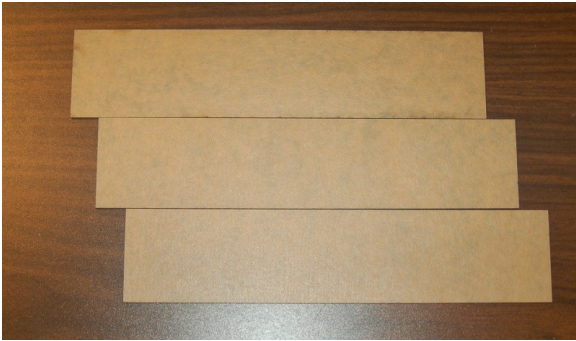

Top Acrylic Panels

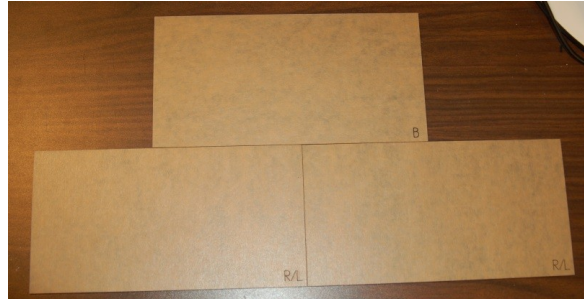

Bottom Acrylic Panels

Both the top and bottom acrylic panels are covered with a paper protective covering. You'll need to peel this paper off before installing the panels.

We'll do the bottom first. Two of the bottom panels are marked "R/L" and are used to cover the X and Y axis spaces. The other panel is marked "B" and is used to cover the Z axis. Start with the Z axis. Insert the acrylic panel as shown – it will rest against the side of the #6-32 flat head screw you installed when building the base. Carefully bend the panel over the back of the Z axis and slide it into the open space on the right – it should come to rest on the #6-32 flat head screw on that side. The other retaining screw is indicated by the green arrow in Fig. 17-10. You'll want to make sure that the laser engraved "B" is facing inward so it can't be seen once the panel is installed.

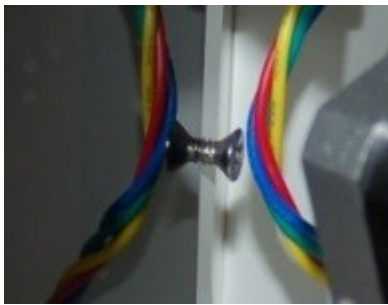

Fig. 17-9: Left retaining screw.



to place.



Fig. 17-11: Z Axis cover installed.

Rostock MAX v2 Assembly Guide

Now install the “R/L” panels on the X and Y axes as shown below. Make sure you've got the laser engraved “R/L” marking facing inward so it can't be seen once installed.

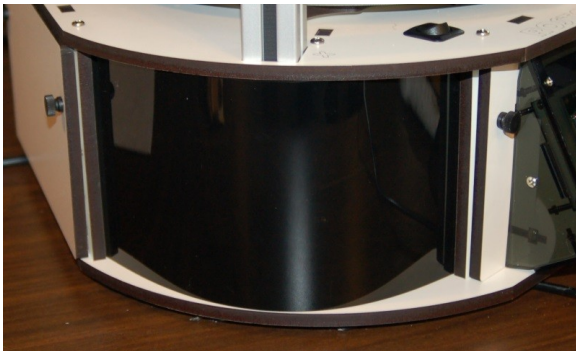

Fig. 17-12: X axis covered.

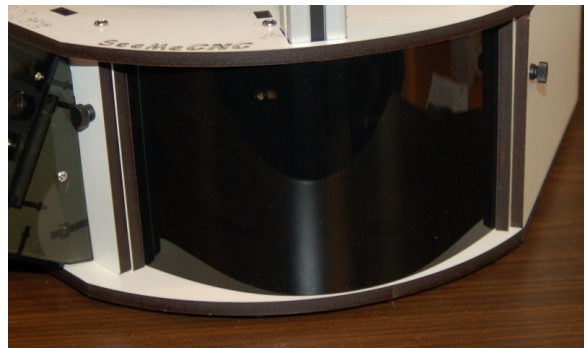

Fig. 17-13: Y axis covered.

The top acrylic covers are all the same size so you don't have to worry about which one goes where. Install all three in the same manner as you did the lower acrylic cover panels.

Dem



Fig. 17-14: Upper acrylic covers installed.

Feet!

Hopefully you haven't lost the little rubber shoes for the feet, because you need to install them now. :)

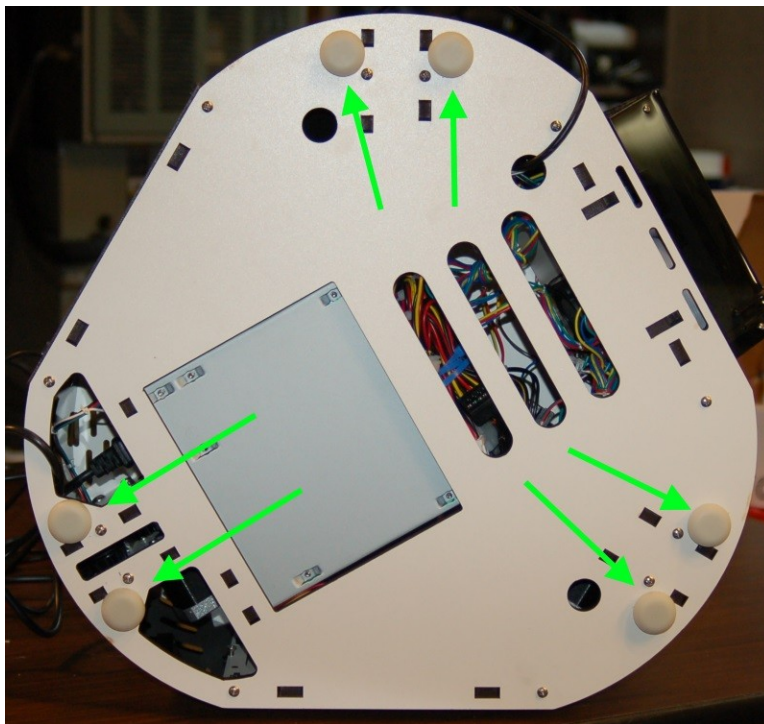

Fig. 17-15: Wrestle the feet away from the cat and install them.

Installing the Borosilicate Glass Build Plate

For this task you're going to need the Borosilicate glass build plate. (But you knew this, right?)

Rostock MAX v2 Assembly Guide

Before you set the glass on the Onyx heated bed, I want you to *carefully* remove the Kapton tape you used to cover the center hole in the bed.

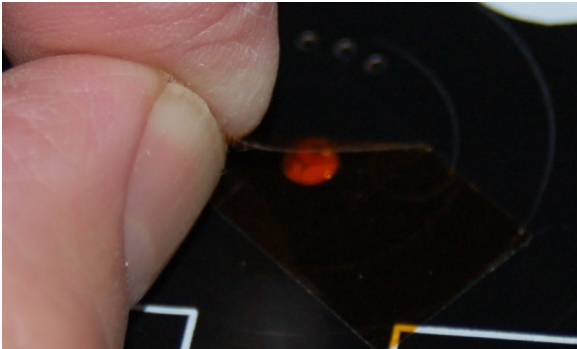

Fig. 17-16: Kapton removal.

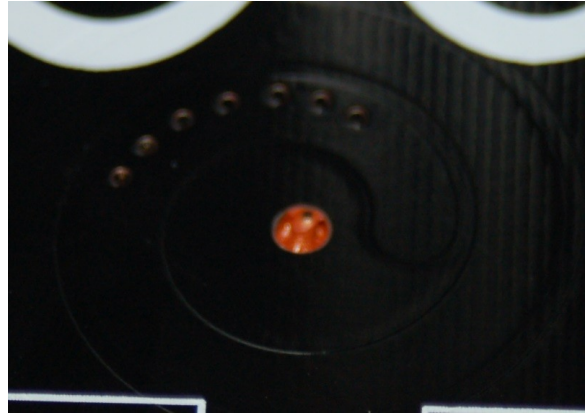

Fig. 17-17: Uncovered thermistor.

The reason you're removing the tape is to ensure that it doesn't lift the Borosilicate glass plate in the center. I know that it doesn't feel very thick, but even a little can make a difference.

Take the glass plate out of the protective shield and using a permanent marker, make a 1/4" wide mark on the edge of the glass.



Fig. 17-18: Glass edge marked.

The mark will give you a guide when replacing the Borosilicate glass build plate if you remove it for any reason. Even though the glass thickness is very consistent, tiny variations in the surface of the glass can introduce calibration issues if the glass isn't replaced in the exact spot it was when you first calibrated your printer. You may even want to make the mark a "T" to help ensure that you get it right side up when re-installing it.

I discovered this issue while working on Orange Menace (my original Rostock MAX v1) recently and thought it was important enough to let new builders know about the potential issue it could cause.

Rostock MAX v2 Assembly Guide

Carefully set the Borosilicate glass plate on top of the Onyx and rotate it so that the mark you put on the glass edge aligns with the center screw next to the bed heat LED as shown below.



Fig. 17-19: Glass alignment.

Now screw up the six document clips that were included in the kit and install them as shown.



Fig. 17-20: Document clips installed.

(I bet the guy that invented those things is constantly amazed at their non-document uses!)

Smoke Test!

One last thing (there's *always* something else, isn't there?) you should do is a final check of all

Rostock MAX v2 Assembly Guide

your wiring in the Rostock MAX v2. Make sure no bare wire is touching any other bare wire, etc. Finally, plug the sucker in and hit the power switch. If everything works as expected, you should here the RAMBo cooling fan (if you listen closely) and the LCD display will display two rows of blocks and no readable text. This means that the RAMBo is active and waiting for a program upload. I'll cover the firmware upload next!



Fig. 17-21: Insert obligatory Dr. Frankenstein quote here.

At the beginning of this project, you'd probably questioned your sanity and your ability to get a 3D printer built from a box of funny smelling wooden parts and some bits of plastic and metal.

You need to appreciate what you've managed to accomplish here. You've not only built a pretty technical kit, but you've joined the ranks of many brilliant and distinguished people on the bleeding edge of 3D printing technology.

Kick back for a bit and relax. Have a beer or other drink of choice (Scotch!) and enjoy the moment. Congratulations on a job well done!

Hey! Put down that beer! We've got software to install!



Checkpoint Video #22:

http://youtu.be/n_S4EZKHkKw

18 – Driver and Software Installation

The Rostock MAX v2 does not include the firmware required to operate it. This was a conscious decision by SeeMeCNC to encourage builders to become more proficient in the operation of their new 3D printer.

Downloading the tools necessary to build and upload Repetier-Firmware is simple and easy. However, before you get to that point, you're going to need to install a driver in order to communicate with the RAMBo controller. If you're using MacOS or Linux, you can skip the driver installation instructions.

Installing the RAMBo Driver

Download the USB Driver zip file from this location:

http://download.seemecnc.com/Software/RAMBo_USBdriver.zip

The driver will work with all versions of Windows – XP to v8.1.

If you haven't done so already, connect the Rostock MAX to your computer using the included USB cable and turn the Rostock MAX on using the power switch you installed previously.

Unzip the file to a temp directory or other place that you know the location of. For Windows users (and likely XP, Windows 8 and Vista users as well), plug in the RAMBo and let Windows “fail” to find the correct driver for the board. Open up the device manager by right-clicking on “Computer” or “My Computer” and select “Properties” followed by “Device Manager”. Scroll down to the “Unknown Devices” entry and right-click on the RAMBo entry. Choose “Update Driver” and then “Browse my computer for driver software” (or something similar to this). Choose “Let me pick from a list of device drivers on my computer”, then click the button for “Have Disk”. Browse to where you unzipped the file you downloaded and then click “OK”. It may complain (depending on OS) that the driver isn't signed – allow it to install it anyway. That's all there is to it. The RAMBo will now appear on your computer as a standard serial port. On my computer it appeared as COM10 – it will most likely be different on yours.

Rostock MAX v2 Assembly Guide

The easiest way to find out what port your RAMBo is listening on is to open up the Device Manager and look for the RAMBo entry. In order to discover this bit of information, you'll need to open up Device Manager (right click on My Computer, click “Properties” and then click “Device Manager”). You'll get a window that looks something like this:

The entry we're looking for is highlighted in green. Your “COM” entry will more than likely be different from mine. Write this entry down as you'll need it very soon.

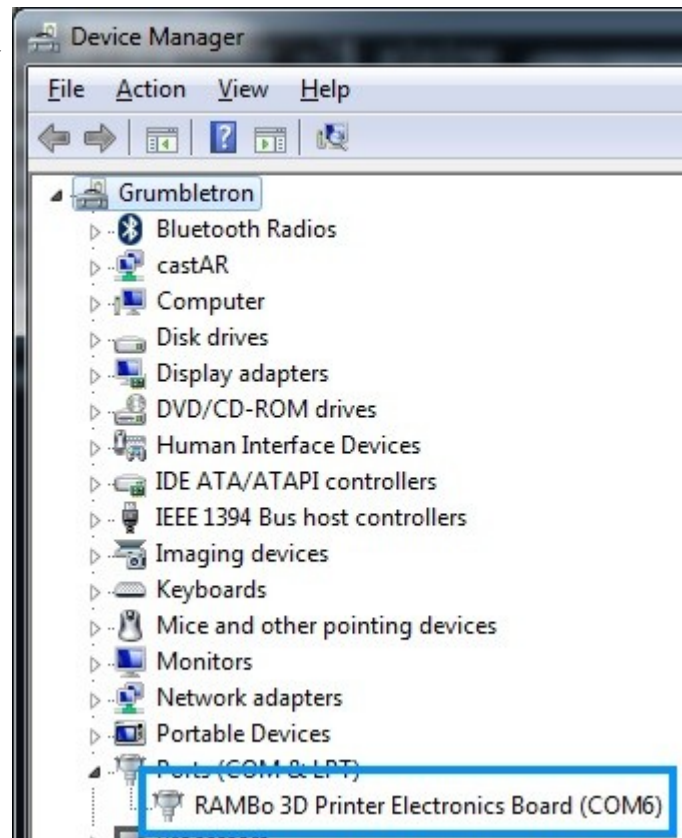

The RAMBo in the Device Manager

Installing the Arduino IDE

In order to compile and upload the firmware to the RAMBo controller, you're going to need the Arduino IDE. This is an open source software development environment targeted at the Arduino family of ATmega-based microcontroller project boards. At its heart, the RAMBo controller is just an Arduino Mega 2560 with a *lot* of goodies attached to it.

You can download the Windows, MacOS and Linux version of the Arduino IDE from here:

<http://arduino.cc/download>

The version of the IDE used as of this writing is 1.6.1

Install the Arduino IDE using the downloaded installer.

Now you need to download the firmware from SeeMeCNC's github repository.

<https://github.com/seemecnc/Repetier-091-ROSTOCKMAX/archive/master.zip>

Unpack the “master.zip” file that you downloaded into a directory where you can keep track of it. You may need to reference it in the future.

Start the Arduino IDE – you should be presented with a screen that looks similar to this:

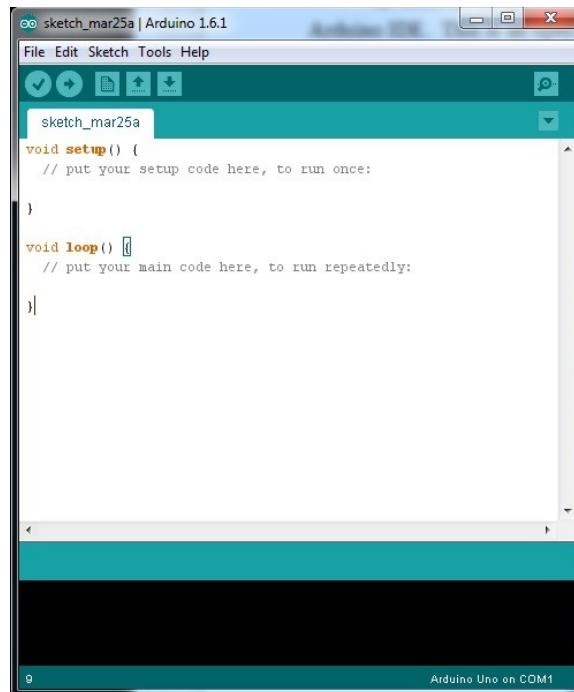

Fig. 18-1 - The Arduino IDE

Configuring the Arduino IDE

Before we can use the IDE to upload the firmware to the RAMBo controller, we need to tell the Arduino IDE what kind of board we have and what communications port it needs to use in order to perform the upload task.

Click on the “Tools” menu item and then click on “Board” and then “Arduino Mega or Mega 2560”.

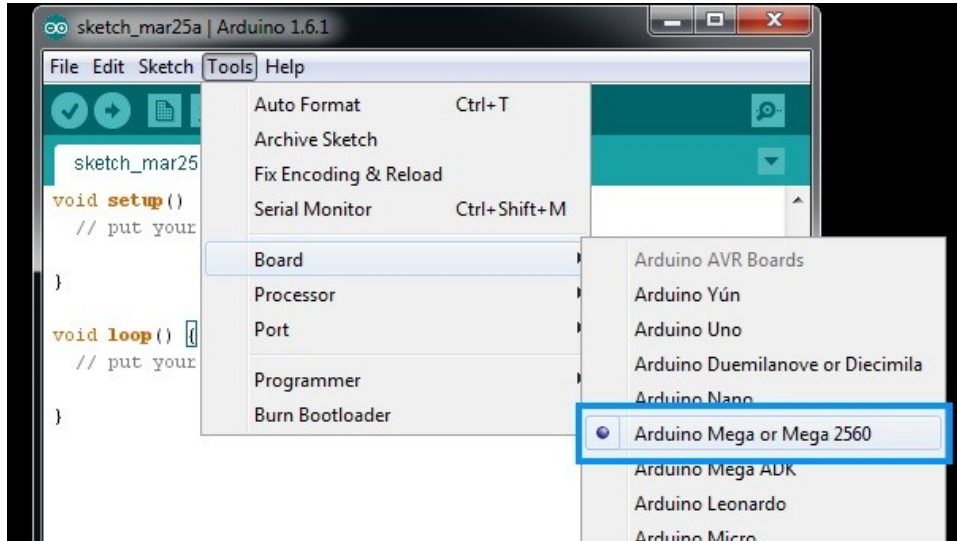

Fig. 18-2: Choosing the board type.

Next, you'll need to tell the Arduino IDE what port to talk to the RAMBo on. To do this, click on “Tools”, “Serial Port” and then choose the COM port that your RAMBo appears as on your computer.

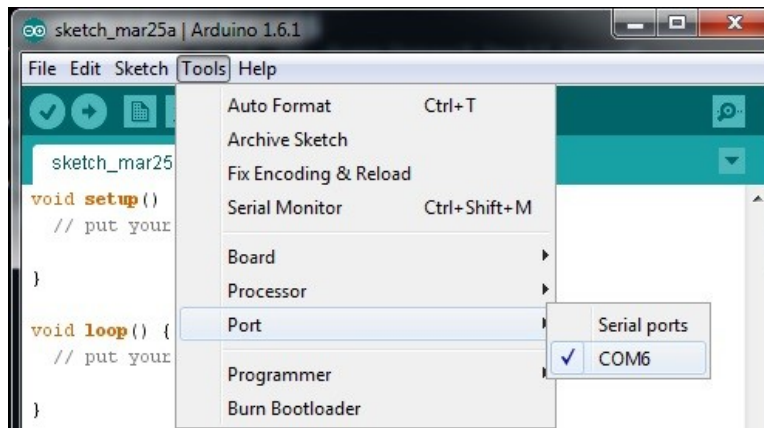

Fig. 18-3: Choosing the Serial Port.

Test Upload

Ok, now that you've got the Arduino IDE configured, we're going to do a quick task that'll do two things. First, it will validate that you've got the Arduino IDE configured properly and that you're able to connect and upload a program to the RAMBo controller. Remember – the RAMBo controller is just an Arduino Mega 2560 with a bunch of goodies piled on top!

Second, the program I'm going to have you run will clear the EEPROM on the RAMBo controller to make sure you start with a clean slate. The EEPROM is an Electrically Erasable Programmable Read Only Memory and it's where Repetier-Firmware will store settings. When you can store configuration information in the EEPROM, it means that you don't have to re-upload the firmware every time you make a change.

Click on “File”, “Examples”, “EEPROM”, and finally “eeprom_clear” as highlighted in green in Fig. 18-4.

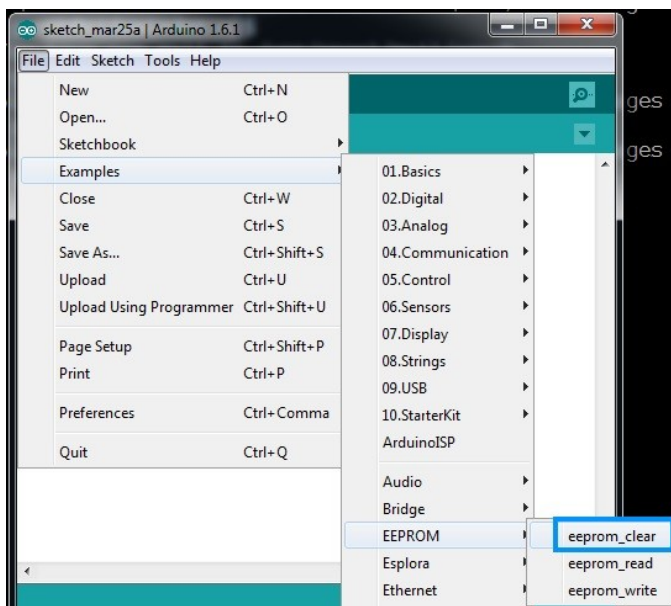

Fig. 18-4: Loading the eeprom_clear program.

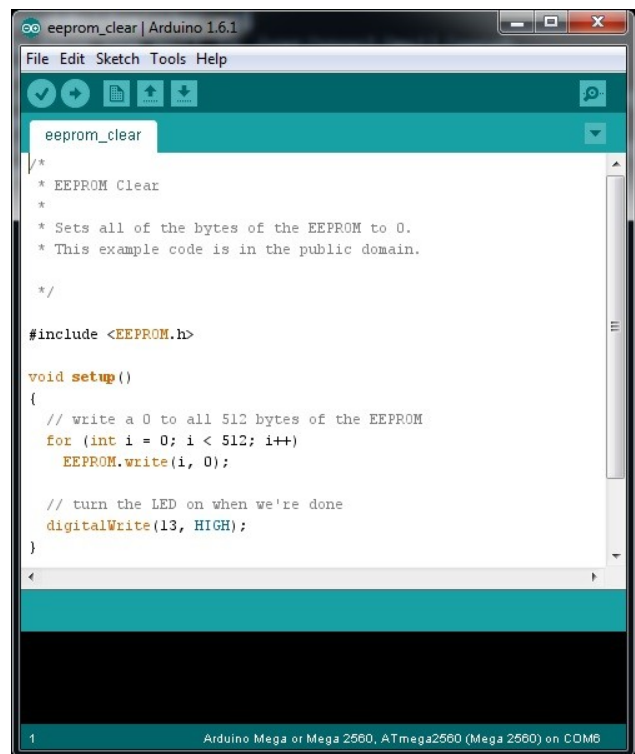

Fig. 18-5: eeprom_clear loaded and ready to go.

The only thing you need to do now is click the “Upload” icon in the Arduino IDE. The upload icon is represented by this symbol:



Rostock MAX v2 Assembly Guide

Turn your Rostock MAX v2 on if you haven't already and then click the Upload icon.

When the upload is finished, you should see results similar to that in Fig. 18-6. The “Done uploading” is the status you want. There is no other external evidence that the `eeeprom_clear` program has done its job, but it has!

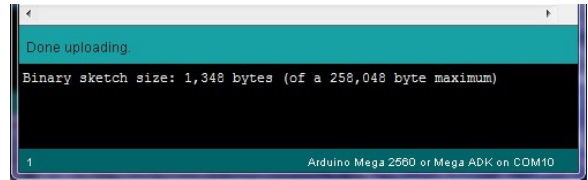

Fig. 18-6:Success!

Uploading Repetier-Firmware

Now it's time to load Repetier-Firmware into the Arduino IDE and upload it to the RAMBo controller!

Click “File”, “Open” and browse to where you unpacked the master.zip file you downloaded from the SeeMeCNC github repository. Select the file “Repetier.ino” and click the Open button.

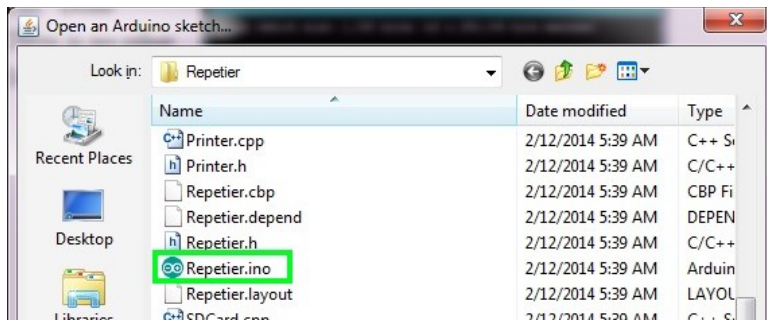

Fig. 18-7: Opening Repetier.ino

Once it's loaded up, the Arduino IDE is going to look something like this:

Go ahead and click on the Upload icon to send Repetier-Firmware to the RAMBo!

Depending on the speed of your computer, this could take up to a few minutes to accomplish. Be patient and wait for the “Done uploading.” status to appear just like it did when you uploaded the “eeprom_clear” program.

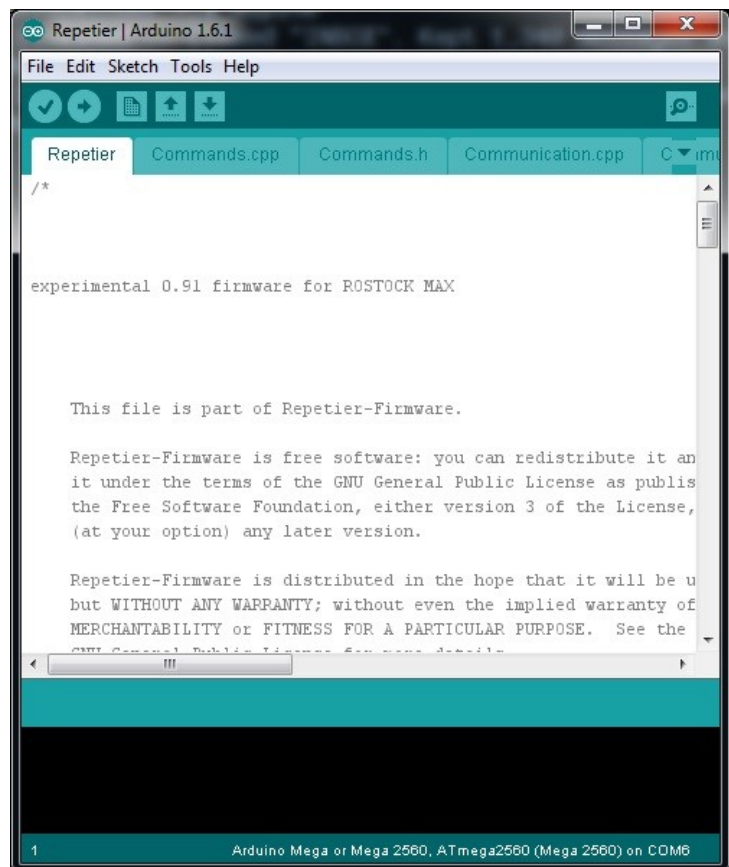
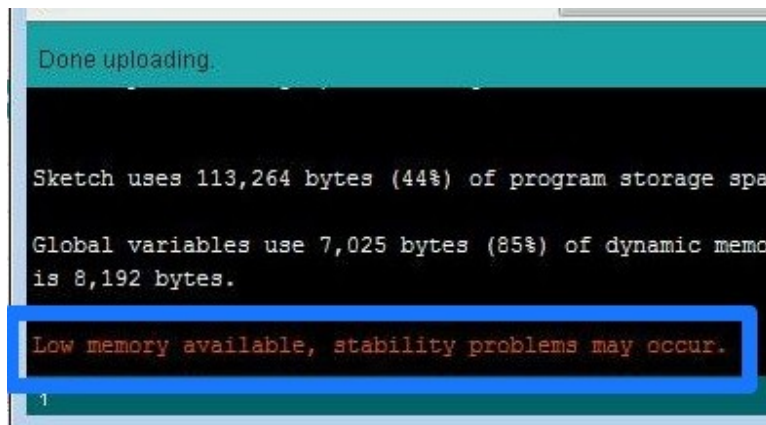

Fig. 18-8: Repetier-Firmware loaded in the IDE.

Rostock MAX v2 Assembly Guide

You may see a warning similar to the one shown below. This is strictly an advisory message and won't affect how the firmware works with your Rostock MAX.



```
Done uploading.  
  
Sketch uses 113,264 bytes (44%) of program storage space.  
Global variables use 7,025 bytes (85%) of dynamic memory,  
which is out of the 8,192 bytes allowed.  
  
Low memory available, stability problems may occur.
```

Compiler advisory message.

When the upload has finished the RAMBo will restart and you should see the following display on the LCD:



*Fig. 18-9: It's **ALIVE!***

Congrats again! You've got a living, breathing (hey, work with me here!) 3D printer that you've *built yourself*.

If for some weird, inexplicable reason you do NOT see that display (or something very, very similar!), carefully retrace your steps. Start back at the beginning with the `eprom_clear` test and go from there. If you still don't get a working display please contact support@seemecnc.com right away!

If your kit was shipped with the Kysan or Automation Technology stepper motors (we covered that earlier, remember?), you're going to need to make a small tweak to the firmware in order to adjust the current drive that they need.

Rostock MAX v2 Assembly Guide

Click on the tab in the Arduino IDE marked “Configuration.h”. At line #701, you should see this text: `#define MOTOR_CURRENT {175,175,175,200,0}`.

Change that line to this: `#define MOTOR_CURRENT {155,155,155,165,0}`

Save your changes and upload the updated firmware to the RAMBo, just like you did in the prior step.

The LCD and Front Panel Controls

Let's go over what information the LCD displays and what the front panel controls do.

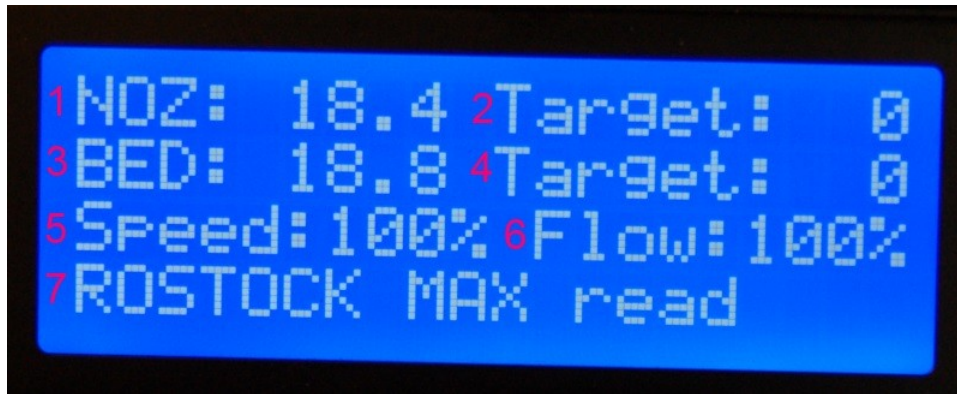

Fig. 18-10: Default LCD display.

1. Nozzle Temperature. This is the temperature at the nozzle as measured by the thermistor that you installed when you put the hot end together. It reads in degrees Celsius – you'll find quickly that just about everything to do with 3D printing is done in Metric units of measure. FYI, 18.4C is 65.12F.
2. Target Nozzle Temperature. When you're printing a part, this field will show you what temperature you've set the hot end to.
3. Bed Temperature. This is the temperature of the Onyx heated bed as measured by the thermistor that you installed in the center of the bed. Just like the nozzle, it reads in Celsius.
4. Target Bed Temperature. This displays the temperature that you've set the Onyx to heat to.
5. Speed Rate. This is the speed multiplier field. Normally it will read 100%, but if you've changed the speed control from MatterControl, this number will display what that setting is. We'll get into this in more detail later.
6. Flow Rate. This shows the current flow rate of the extruder. This is also a field that is controlled from MatterControl.

Rostock MAX v2 Assembly Guide

7. Status Line. This is a multipurpose display field that will change depending on what the printer is currently doing.

The front panel:



Fig. 18-11: The Front Panel.

1. The LCD Display. (but you knew that, right?)
2. Beeper. That's it does. Beeps. (and beeps, and beeps and beeps...)
3. Input Controller. Turning the knob clockwise & counter clockwise is how you navigate through the LCD menus. Pressing the button straight in acts similarly to a mouse click – it selects the current menu item.
4. Emergency Reset Button. When you hit that button, a number of things are going to happen. First, the RAMBo is going to turn off both the heat bed and the nozzle heaters. Next, it's going to send all three Cheapskates to their “home” positions at the top of the Rostock MAX v2 and then the RAMBo controller will reboot itself. If the printer is really going nuts on you, this is the fastest way to make it behave.

Note that in order to operate the reset button, you need to press **hard**. You'll hear it click, but that's kind of deceptive. The button doesn't close until more force is applied to the little reset button arm. It is somewhat of a safety feature to prevent accidental resets during a print job.

Rostock MAX v2 Assembly Guide

The last thing I'm going to cover in this section is the “activity” display that the LCD can show you. Turn the knob either direction and you'll get a display that looks something like this:

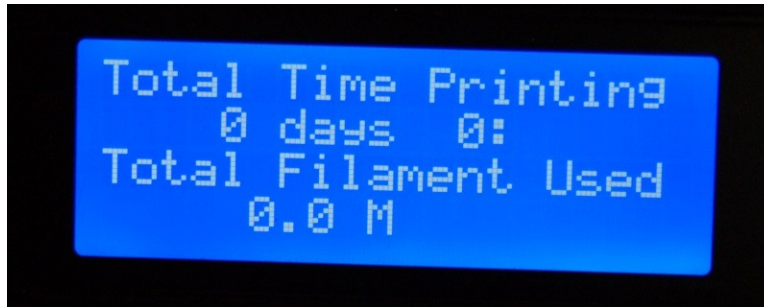

Fig. 18-12:Activity display.

This will tell you at a glance how much time your Rostock MAX v2 has spent printing and how much filament it's used in the process. The time display breaks down into days, hours and minutes. The filament display shows filament used in fractional meters.

Now let's get this thing calibrated and printing!

19 – Installing MatterControl and Calibrating the Printer

This is the fun part! The Rostock MAX v2 3D printer is very easy to calibrate, but it can take some time and a number of iterations to get it as good as you can. You'll want to take your time here because the better you calibrate the printer, the better it will perform.

Downloading, Installing, and Configuring MatterControl

The “host” software of choice for the Rostock MAX is called MatterControl.

MatterControl is a full featured and multi-platform host interface for 3D printers. There are other host interfaces out there such as Octoprint, Repeater-Host, and Pronterface, but this guide will only cover MatterControl. MatterControl is available for Windows and MacOS platforms. If you've got a Linux machine, you'll want to look into either Pronterface or Repetier-Host.

MatterControl can be downloaded from <http://seemecnc.com/pages/downloads>. Scroll down to the “Software” section.

After the download completes, run MatterControl and click on “File” and then “Add Printer”.

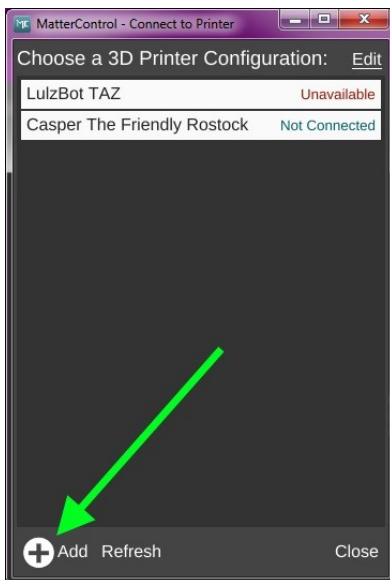

Fig. 19-1: Add Printer.

Click the “Add” button as highlighted on the left. This will open a dialog box that you'll use to name and configure your printer.

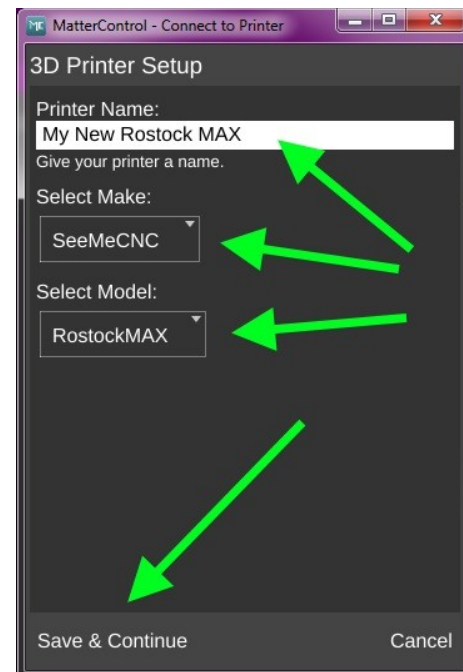

Fig. 19-2: Printer setup.

Click in the “Printer Name” field and enter a name for your Rostock MAX v2 3D printer. I've named mine “Casper The Friendly Rostock”. (quit laughing)

Rostock MAX v2 Assembly Guide

Select “SeeMeCNC” from the “Select Make” drop-down box and then “RostockMAX” from the “Select Model” drop-down.

Note that since you're using the SeeMeCNC customized version of MatterControl, “SeeMeCNC” will be the only option for the make. The model drop-down will contain other models of SeeMeCNC printers as well as “Other” if you'd like to configure MatterControl to use a non-SeeMeCNC printer in the future.

Click the “Save & Continue” button to continue.



Fig. 19-3: Auto-detect printer.

When the new printer configuration is saved, MatterControl will then try to auto-detect the printer. It does this by attempting to interrogate printers on each serial port present on your computer.

MatterControl can detect what kind of firmware it's talking to based up on the response it gets for this step.

The first step shown in Fig. 19-3 is a bit unclear – the MatterControl guys are assuming that you might have gotten ahead of yourself. If you DID connect MatterControl (using the CONNECT button), go ahead and click the DISCONNECT button and then bring the 3D Printer Setup dialog to the front by clicking on it in the task bar.

Go ahead and click the Continue button. You'll be presented with a new dialog as shown in Fig. 21-4.



Fig. 19-4

Make sure you've got the USB cable connected to the RAMBo and your computer. Power on your Rostock MAX v2 and then click the “Connect” button.

Rostock MAX v2 Assembly Guide

If for some reason MatterControl cannot “see” the Rostock MAX v2, you may see an error like the one shown below.



Fig. 19-5: Oops!

If you do get this error, click on the “Manual Configuration” link at the bottom of the dialog box.



Fig. 19-6: Manual Configuration

The Manual Configuration link will bring up a dialog box that allows you to choose which communication port your printer is connected to.

You'll be presented with a list of the serial ports that MatterControl can currently “see”. If you don't see any ports, or the one you need isn't listed, then click the “Refresh” button at the bottom of the dialog. If the port STILL does not appear, check to make sure that the USB cable to the Rostock MAX v2 is correctly connected and the printer is turned on. If you still see no port after clicking Refresh, please contact SeeMeCNC support!



Fig. 19-7: Serial port selection

Rostock MAX v2 Assembly Guide

If your port is listed, click on the little circle to select it and then click the “Connect” button at the bottom of the dialog. You should be rewarded with the following dialog:

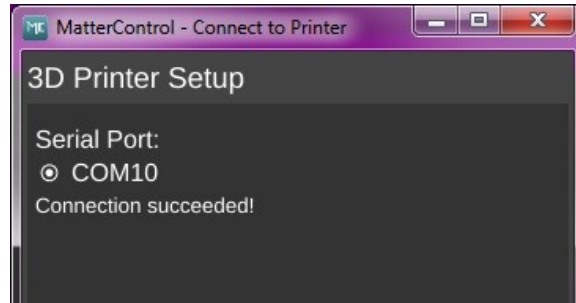

Fig. 19-8: Success!

Click the “Done” button and let's continue!

Maximize the MatterControl window to see the entire main screen. If you shrink the size of the main window, features “fold” away to keep from cluttering the display. It's actually pretty clever.

Before we get to the details of getting your printer calibrated, let's cover what features are available from MatterControl. Because the MatterControl display does contain so much information, I'm going to break it down into smaller segments to make the screen shots easier to see as I describe the various components in MatterControl.

1. This is the print queue display. If nothing is queued up, you'll see the message, “No items in the print queue”. To add an item, you can click the “Add” button. We'll cover this in detail later. Note that you can only select STL or GCODE files here.



Fig. 19-6: Status & Print Queue Pane

Rostock MAX v2 Assembly Guide

2. This is the temperature display. The top number displays the current nozzle temperature and the bottom number covers the heated bed. Both temperatures are displayed in degrees Celsius.
3. Queue count. This lists the number of objects currently loaded in the print queue.
4. Library – this is a list of items that you've stored in your object “library”. We'll cover this one in detail later as well.
5. Print History – Clicking here will show you information about your recent print jobs, including their start & end times as well as whether or not the job was completed.
6. About – Just gives you information on the fine folks that created MatterControl and a button to check for updates or send the MatterControl developers feedback.
7. Advanced Controls – this is where you can manually control your Rostock MAX v2.
8. The **Add** button will allow you to add objects or G-Code files to the print queue.
9. The **Create** button displays a list of available plug-ins that are used to create printable objects right inside of MatterControl.
10. The **Options** button opens a menu list that will allow you to export the current file and perform other operations on the print queue.

Rostock MAX v2 Assembly Guide

The right half of the MatterControl interface is occupied by a 3D view of your build platform and what objects are currently loaded and ready to print.

1. The 3D and Layer view controls allow you to switch between the 3D view (shown) and the Layer view. The layer view shows you the path the print head will take as your part is printed. The layer view won't display anything until the part you want to print has been “sliced”.

2. View manipulation controls – Rotate, Pan, and Zoom. By default, the 3D view will show a rotating display of the part. You can stop the rotation by clicking anywhere in the 3D view window.

3. The object currently ready to print.

4. This is a representation of your Rostock MAX v2's print bed. As long as your object fits within the circle, you should be able to print it!

5 & 6. The **Insert** and **Edit** buttons allow you to add objects to the current print job as well as manipulate them.

7. The **Export** button allows you to save the current state of the build plate in a few different file formats.

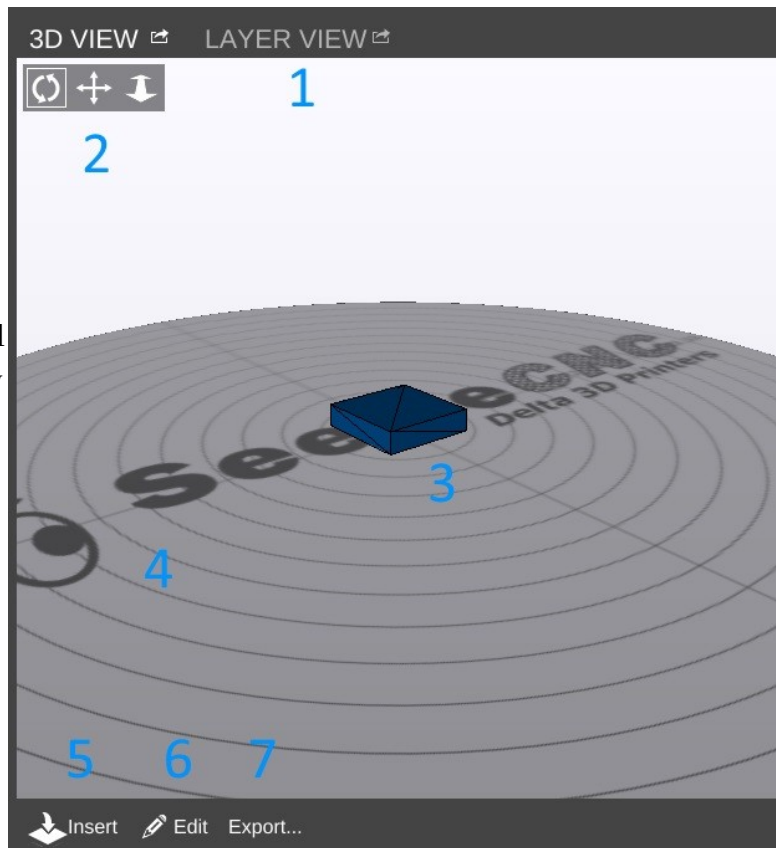

Fig. 19-10: The Model Pane

Rostock MAX v2 Assembly Guide

Next, we've got what I call the “Controls” pane. This pane allows you to directly control your printer, change its configuration and change slicer settings.

There's a lot going on with this pane, so I'll go into more detail with it as you need to use it as well as in a later chapter.

Let's move on to getting your printer ready to calibrate!

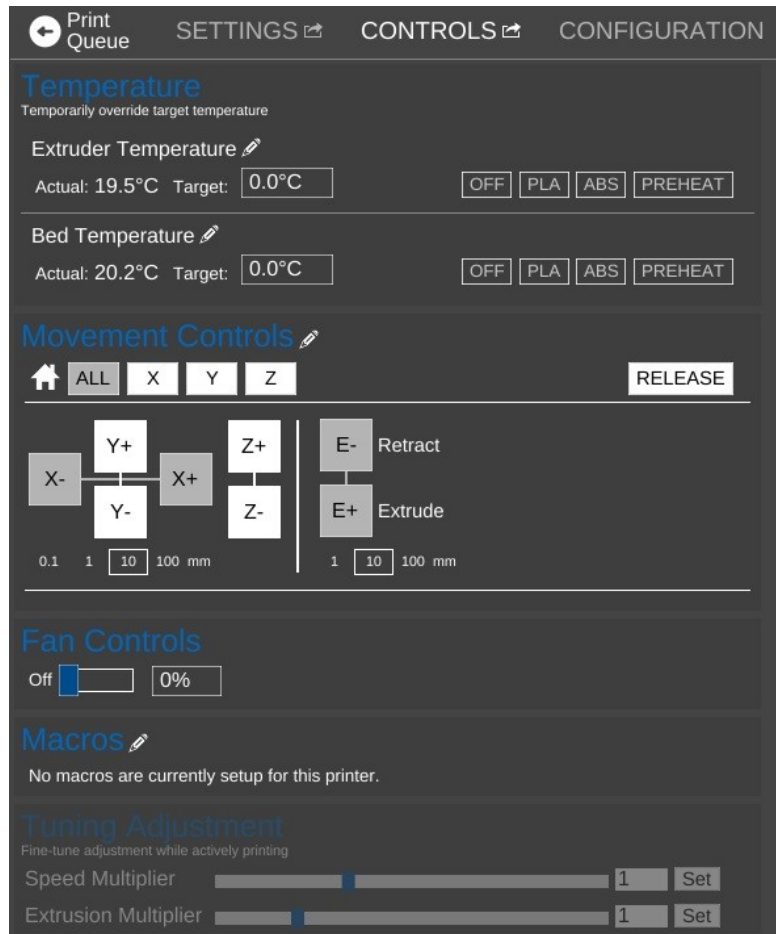

Fig. 19-11: The Controls Pane.

Initial Function Tests

Before the calibration process can begin, we need to perform a test of the end-stop switches to make sure that they're functioning correctly. In order to perform this test, you'll need to be able to directly “talk” to the Rostock MAX v2. Click on the “Configuration” option as shown below.



Fig. 19-12: Configuration.

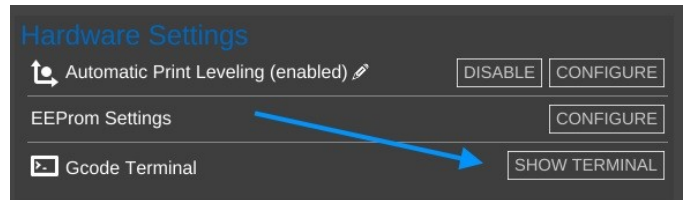

Fig. 19-13: The Terminal button.

Click on the **SHOW TERMINAL** button. This will open up the terminal screen that we need to use to directly communicate with the printer. When the terminal window first opens, you'll see it displaying information that's coming from the printer. This data is being processed by MatterControl to update the temperature displays, etc. The terminal is easier to work with if we turn that information off. To do so, click on the **Filter Output** check-box as shown below.

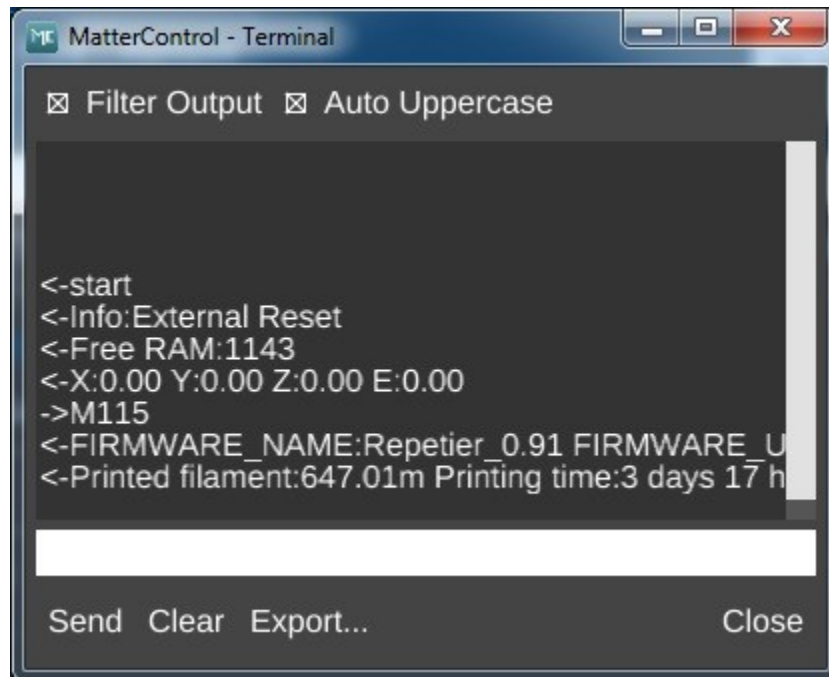
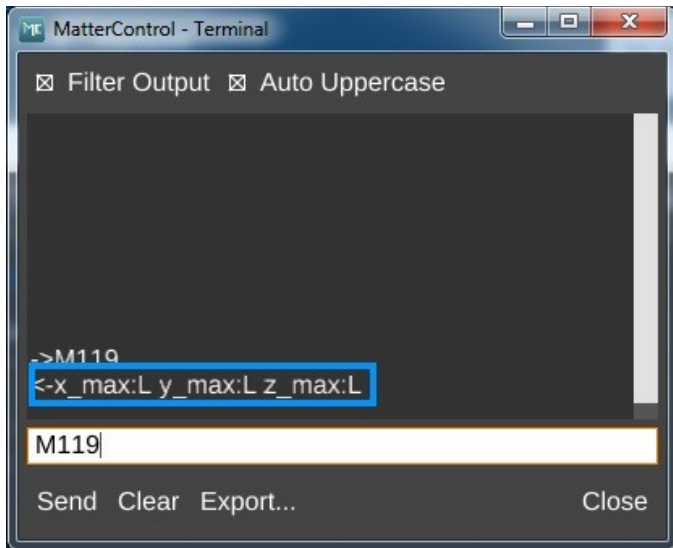

Fig. 19-14: Filtering the terminal output.

Rostock MAX v2 Assembly Guide

Now we can send the commands necessary to test the end stop switches. It's important that they operate properly as they're used by the printer to determine the “home” position for the three towers.

Ensure that the end-stop adjustment screws are not in contact with the switches and then enter “M119” into the terminal input box and press the **ENTER** key.



The **M119** command instructs the RAMBo board to return the current state of the three end stop switches. The three switches are known as “x_max”, “y_max”, and “z_max”. Each one should have an “L” next to it as shown in Fig. 19-15. If any of them show an “H”, check your wiring to ensure that the switch is connected properly at both ends. The printer will not operate properly if any of the end-stop switches are reporting “closed” when they're not.

An “L” next to each label indicates that all three end-stop switches have not been pressed. If you see anything different, please check your wiring as mentioned previously! Now I want you to hold down the switch lever for the X axis and re-send the **M119** command. You should see the **x_max** value change to “H”. Do this for the Y and Z axes. This will ensure the end stop switches are functioning – this is very important for the next step!

Click the **CONTROLS** button to get to the screen where we'll perform the movement tests.

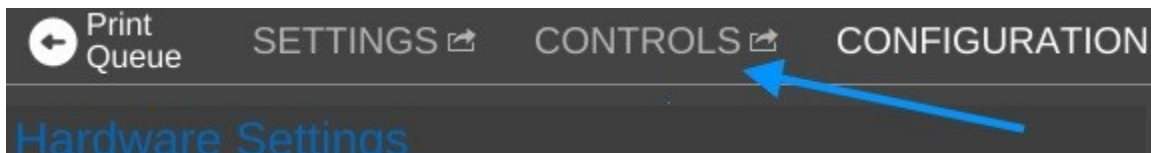

Fig. 19-16: Back to the Controls pane!

The next test we're going to perform involves making sure that the stepper motors on the towers are wired correctly. Every once and a while we'll see a stepper motor with the connector wired correctly, but the internal wiring is *backwards*. Maybe the elves that build stepper motors were having a bad cookie day or something. Let's find out if you won a bad cookie motor!



Fig. 19-17: Home Axes.

Rostock MAX v2 Assembly Guide

The next task is to make sure that you can “home” the machine. By clicking on the **ALL** button shown in Fig. 19-17, it should send all three axes up to the end-stop switches.

With one finger on the power switch, click that **ALL** button! If *any* of the three axes do not head up to the top of the machine, **turn off the power immediately!** You don't want to do any damage to the machine due to an inverted axis. Don't worry though, fixing an inverted axis is VERY easy!

If you need to apply this fix, click the **DISCONNECT** button in MatterControl and then open up Repetier-Firmware in the Arduino IDE. Click on the tab marked “Configuration.h”. You may need to increase the width of the IDE window in order to see that tab.

Scroll down until you find a small section marked “// Inverting axis direction”.

```
// Inverting axis direction
#define INVERT_X_DIR true
#define INVERT_Y_DIR false
#define INVERT_Z_DIR true
```

Fig. 19-18: Axis directions.

Once you've located this area, I want you to change the entry that corresponds to your misbehaving motor to the opposite of its current setting. If it's currently **true** set it to **false** and vice versa. If you have more than one, change those as well. For example, if your Y axis Cheapskate headed for the floor when you hit the reset button, you'll change **INVERT_Y_DIR** to **true**. Once you've made your changes, click “File”, “Save” and then hit the Upload icon to send your updated firmware to the RAMBo controller.

Once the upload finishes, click the **CONNECT** button in MatterControl to reconnect to the printer. You'll need to click on the **Advanced Controls** button in order to return to the control screen.

The next test involves moving the axes around to make sure they're free and clear and there's no “bad” noises going on. Make sure that you're on the **CONTROLS** screen and hit the Home All icon line you did before. All three axes should travel to the top of the machine and “bounce” off the end stop switches.

Click the **CONFIGURATION** button and then click the **SHOW TERMINAL** button.

Send “**G0 Z200 F3500**”. This will move the effector platform down a few centimeters. The idea is to get them off the end stops so we can move things around a bit.

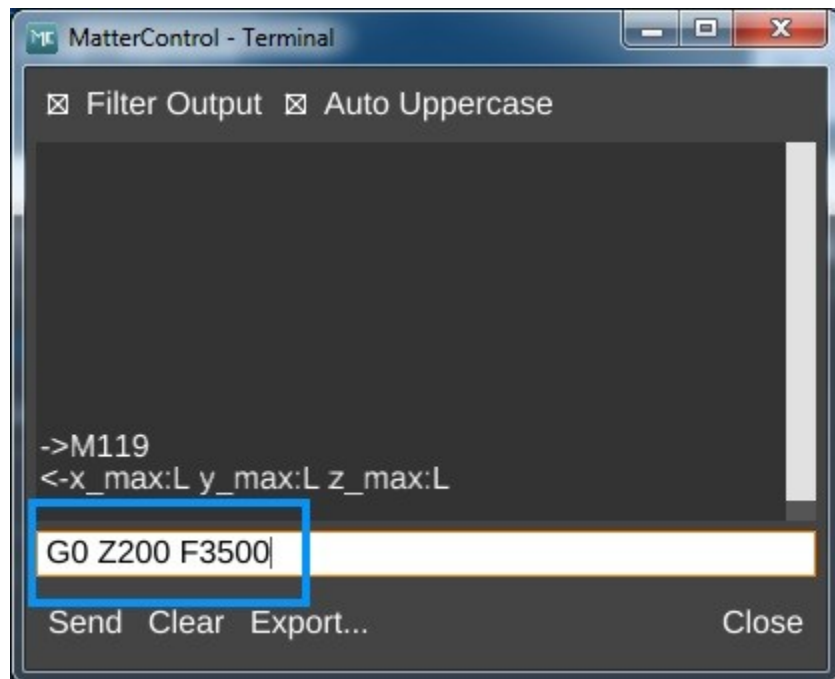

Fig. 19-19: Getting some room to move!

Close the terminal window and click on the **CONTROLS** button to return to the control screen.

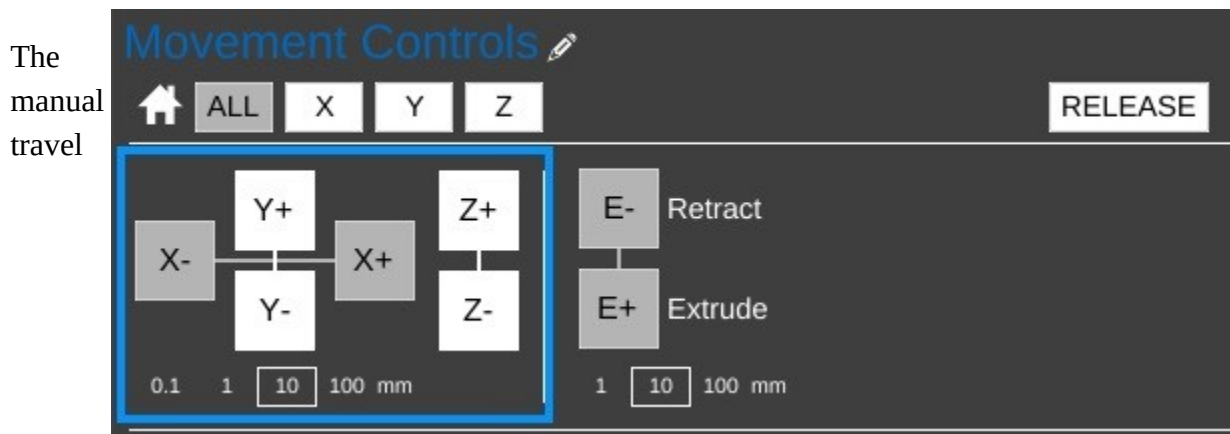

Fig. 19-20: Manual travel controls.

Rostock MAX v2 Assembly Guide

controls (outlined in blue, above) will allow you to manually move the effector platform around the operating area. The X axis buttons will move the effector platform to the left (X-) and right (X+). The Y axis buttons will move the Y axis toward the front of the machine (Y-) and toward the back of the machine (Y+). The Z axis buttons will raise (Z+) and lower (Z-) the effector platform.

Under the axis controls you'll see four values with a square box around the "10" value. These values dictate how much to move the effector platform with each click of an axis button. The values are in millimeters. The ".1" value will set the travel distance to 0.1mm and the "100" value will set the travel distance to 100mm.

Experiment with how the machine moves by clicking on the axis controls. Be careful not to drive the hot end outside the boundaries. If you accidentally do that, just power the machine off and back on. Click the **DISCONNECT** button and then hit **CONNECT** to re-establish communication between the Rostock MAX v2 and MatterControl. You'll need to re-home the machine before you continue experimenting.

While learning how the motion controls work, please keep the Z height (the distance from the tip of the hot end to the build surface) a few inches above the build platform. We haven't set the Rostock MAX's true Z height yet and you don't want to smash the hot end into the bed by accident.

The last test involves checking the basic function of both the hot end heating resistors and the heated bed. For this test, you're only going to turn them on long enough to verify that they're indeed heating up as they should.

We'll test the hot end first. In the

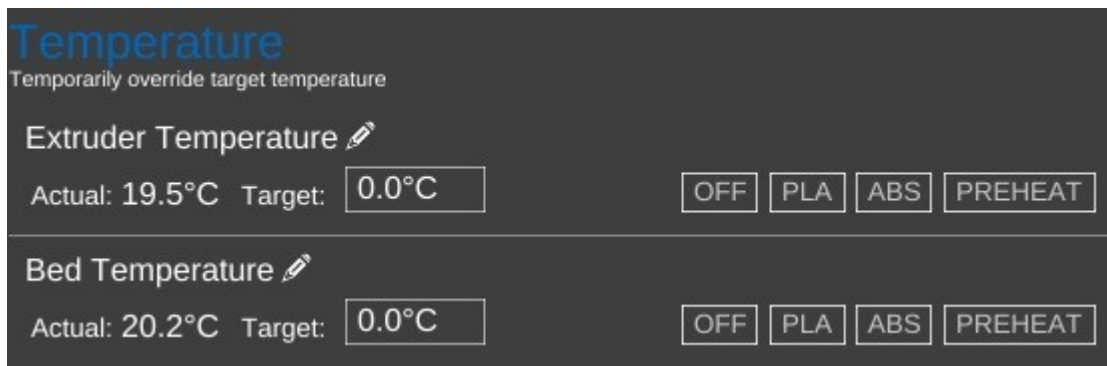

Fig. 19-21: Manual temperature controls.

Extruder Temperature Override section, click in the "Target:" box (where it reads 0.0) and type in

“200” and press **ENTER** or click on the **SET** button that appears when you begin typing in the field.

Once you see the “**Actual**” temperature (“25.0C” above) begin to climb, wait a few seconds and then click the **OFF** button to turn it off. Perform the same test with the heated bed by setting the target temperature in the **Bed Temperature Override** to 50. You'll notice that after you turn the heaters off that the temperature will continue to climb for a short time. This is normal behavior. It's just like a burner on a stove. When you turn it on for a short time and turn it off again, it'll still continue to heat for a short time until the surrounding air can cool it down. As the bed heats, you should see the “**BED HEAT**” LED illuminate. If it doesn't and you see the bed heating on the LCD, check the polarity and wiring of the LED.

The reason you don't want them to reach the target temperature is because the PID loops need to be calibrated before they can be used for printing. (See: http://en.wikipedia.org/wiki/PID_controller for more information on the system the Repetier firmware uses to control the hot end and heated bed temperatures.)

Optimizing The Temperature Control Algorithms

Okay, now that you've spent the last 5 minutes (Who am I kidding? You've been poking at it for at least an hour, giggling like a little kid. Your dignity is the first casualty of having your own 3D printer. Don't worry, you're in good company.) moving the hot end around and seeing how it works, now it's time to get it calibrated so you can begin printing your army of squirrels and Yoda heads.

In order for the mechanical calibration to be accurate, we need to do the steps with the Rostock MAX at operating temperature. This means that both the hot end and heated bed must be at the temperature they'd normally be at while printing.

It's very important that the temperature controlling algorithm in the RAMBo (the PID loop) be as accurate as possible. To do this, we need to run what is called the “PID Auto tune” routine. This is a firmware function that you run in order to determine the best values for the P(roportional), I(ntegral) and D(erivative) values used by the PID loop.

WARNING: At no time should you allow your hot end temperature to exceed 245C! The PEEK section of the hot end will melt at 247C, requiring its replacement!

First, let's start the auto tune routine for the hot end. Open the terminal window as you have before and send the command “**M303 S200**”. This begins the auto tune process and when it starts, it begins to display information in the terminal window. The target temperature for this process is 200C

(that's what the “S200” is for).

It will begin with the entry, “PID Autotune start”. You'll notice that the temperature in the hot end will begin to climb. A few minutes later, you'll start to see more information appear in the log window. **IMPORTANT: Your hot end may smoke a *tiny, tiny* amount when reaching temperature. If it smokes more than just a little, power off the printer immediately and check your wiring and make sure no damage has been done! Correct any wiring errors you find, repair any damage done and start this task again.**

The PID auto tune function is “learning” how to better manage the temperature in the hot end.

In a few minutes, the routine will complete, and you'll get output similar to what you see in Fig. 19-22. Enlarge the terminal window so you can see the whole process, from the “Start” label to the “Finished” label.

```

MatterControl - Terminal
  x Filter Output  x Auto Uppercase
Info:PID Autotune start
bias: 170 d: 84 min: 193.94 max: 202.22
bias: 170 d: 84 min: 197.58 max: 202.22
bias: 164 d: 90 min: 198.79 max: 201.67
Ku: 39.81 Tu: 31.92
Classic PID
Kp: 23.88
Ki: 1.50
Kd: 95.28
bias: 160 d: 94 min: 198.79 max: 201.48
Ku: 44.43 Tu: 27.40
Classic PID
Kp: 26.66
Ki: 1.95
Kd: 91.32
bias: 160 d: 94 min: 198.79 max: 201.48
Ku: 44.43 Tu: 26.88
Classic PID
Kp: 26.66
Ki: 1.98
Kd: 89.56
Info:PID Autotune finished ! Place the Kp, Ki and Kd constants in the Configuration.h or EEPROM
  
```

Fig. 19-22: PID Autotune results.

With some printer builds, the PID auto tune may abort with a message like this: “Error:PID Autotune failed! Temperature too high”. This doesn't mean something is broken – it simply indicates that the RAMBo is applying too much power to the hot end during the auto tune process. This results in an “overshoot” condition where the temperature goes 10+ degrees past the max set point for the auto tune process. (In this case, that would be 200 Celsius.) In order to fix this, you need to *temporarily* dial back the amount of power being used on the hot end. In order to do this, you'll need to edit the setting, “Extr.1 PID drive max” parameter in the EEPROM table.

The EEPROM table editor is on the same screen as the terminal. Click on “EEProm Settings” box to open the editor and scroll down to the parameter shown below.



By default, this

value is 205. Write that down as you'll need to put it back in there once the PID auto tune process is

Rostock MAX v2 Assembly Guide

completed. Change the value to 128 and click on the “Save To EEPROM” button and restart the auto tune process once the hot end has cooled to room temperature.

Once the auto tune is completed, the values that you're interested in are the “Kp”, “Ki” and “Kd” values. There are three blocks of these values, each under the heading “Classic PID”. Create an average of all the values (add up all the Kp values, divide by three. Do the same with the Ki and Kd values) and we'll get them added to the proper spot in the EEPROM table.

In order to store your new set of PID values, we need to open up the EEPROM table editor. The EEPROM table editor is on the same screen as the terminal. Click on “EEProm Settings” box to open the editor, just as you did if you needed to adjust the PID max value.

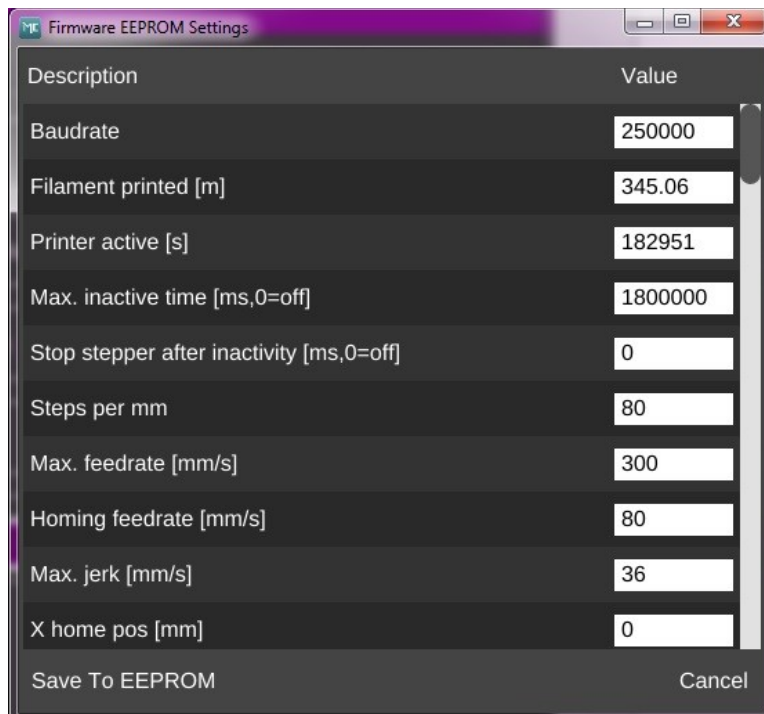

Fig. 19-23: EEPROM Table Editor.

Scroll down until you see the fields highlighted in green as shown below in Fig. 19-23. Change the P-gain field to the value you calculated for the average of K_p . Do the same for the I-Gain (K_i) and D-Gain (K_d) values and then click the **Save To EEPROM** button.

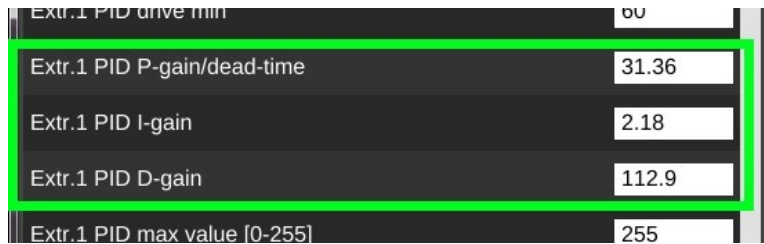

Fig. 19-24: Extruder PID settings.

Don't forget to change the “Extr.1 PID drive max” parameter back to its default if you needed to dial it back!

Setting the Z Height

Bring your hot end and heated bed up to operating temperature. Set the hot end temp to 190C and the heated bed to 55C. We want the hot end and bed to expand to “normal” so we can get a fairly accurate measurement here.

Once the hot end and bed have reached their target temperatures, push the knob in on the LCD controller. This will take you to the LCD menu. Turn the shaft counter-clockwise until you reach the “Advanced Settings” entry and then click the button to select that option.

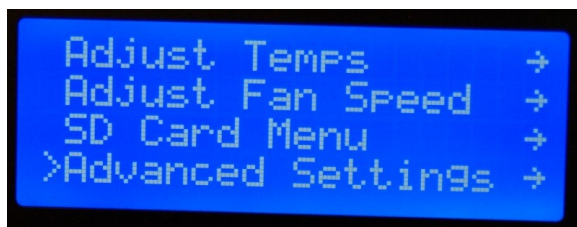

Fig. 19-25:Advanced Settings.

Rotate the shaft counter-clockwise until you reach the “Calibrate Z Height” option and click the button.

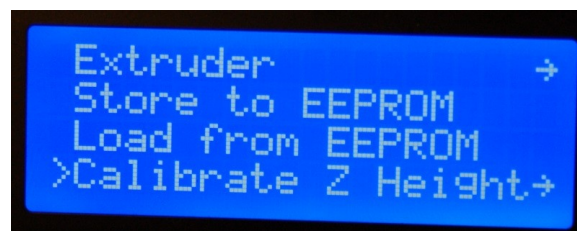

Fig. 19-26:Calibrate Z Height.

Rotate the knob counter-clockwise again and choose the “Home Towers” menu option and click. This will send the Rostock MAX to the home position. This is the same as sending **G28** to the printer or clicking the “Home All” icon in MatterControl. After the homing process finishes, select the “Z-Position” option and click.

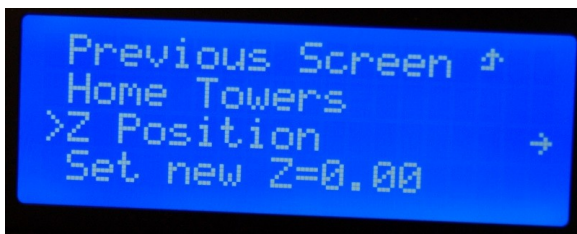

Fig. 19-27: Z Position.

When you click on the Z-Position option, you'll see a display similar to that shown below.

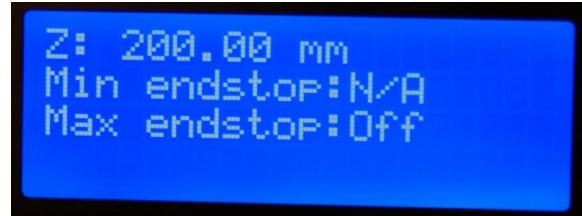

Fig. 19-28: Adjusting the Z height.

You control the height of the effector platform by turning the shaft on the LCD panel. Turning it counter-clockwise will lower the nozzle, and turning it clockwise will raise it.

If you turn the shaft quickly, you'll get large changes and if you turn it slowly, one step at a time, the change will only be 0.01mm per click. **Please be careful not to accidentally burn yourself on the heated bed or the nozzle!**

Turn the shaft counter-clockwise until you're about 1/2" from the bed surface. Place a sheet of paper on the bed, under the nozzle. Lower the nozzle slowly until moving the paper around causes it to drag a little bit on the nozzle tip. You want it close enough that you can push the paper under the nozzle, such that it *almost* prevents you from pushing the paper under the nozzle.

When you've reached that point, press the knob to return to the LCD menu and then and select the “Set new Z=0.00” option. This will set the correct Z-Height for your Rostock MAX v2.

Adjusting The End-Stops

Now we need to calibrate the end stops. This ensures that the effector platform your Rostock MAX v2 achieves an accurate nozzle height and parallel travel across the entire bed surface.

To make this process easier, we're going to create a macro within MatterControl.

In order to create a new macro you'll need to open the macro editor. Click on the little pencil

Rostock MAX v2 Assembly Guide

icon shown on the **CONTROLS** screen.

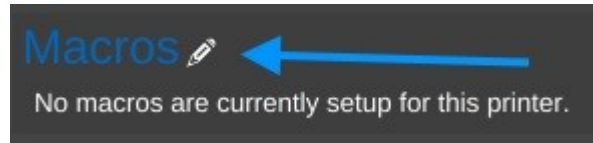

Fig. 19-29: Starting the Macro editor.

This will bring up the Macro Editor, as shown in Fig. 19-30. Click on the “**ADD**” button to create a new macro.

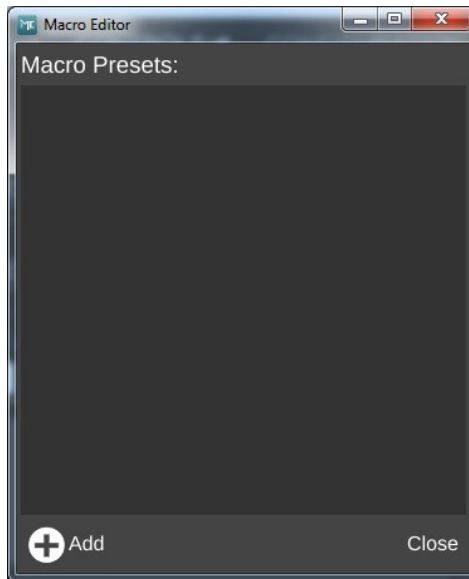

Fig. 19-30: Macro Editor.

You're going to name the new macro, “Tower Cal”. In the Macro Commands box, you'll enter:

; Rostock Max Tower end-stop calibration script

G28

G1 Z0 F15000

G4 S5

G1 X-77.94 Y-45 Z0 F2000

G4 S5

G1 X0 Y0 Z0

G1 X77.94 Y-45 Z0

G4 S5

G1 X0 Y0 Z0

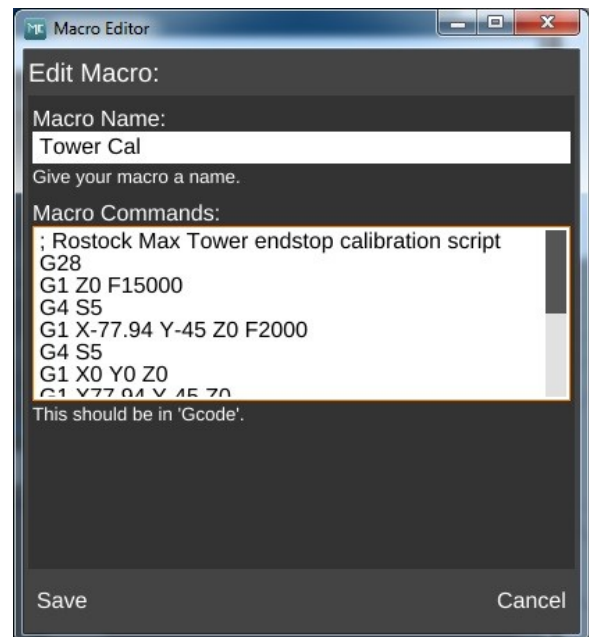

Fig. 19-31: Tower calibration macro.

G1 Y90 Z0

G4 S5

G1 X0 Y0 Z0

If you're reading this as a PDF, you can easily copy & paste the G-Code into the editor window.

Click the **Save** button to save the new macro.

When you're done, click the **Close** button on the Macro Editor. The **CONTROLS** screen should now have a macro display that looks like the figure below.

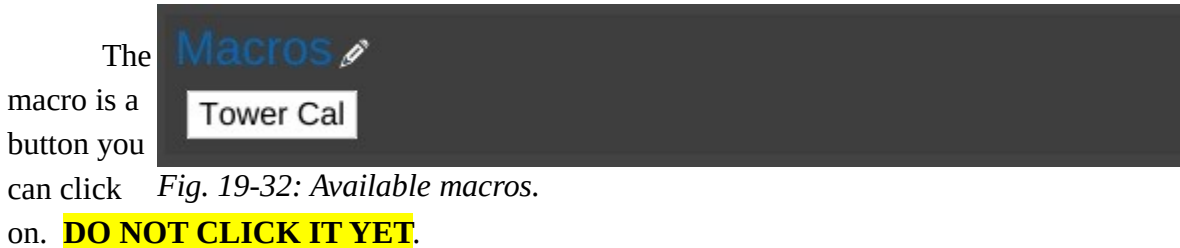

In order to make the calibration as accurate as possible, you'll need to bring both the heated bed and the hot end to operating temperature. The simplest way to do that is to click the “ABS” buttons as shown:

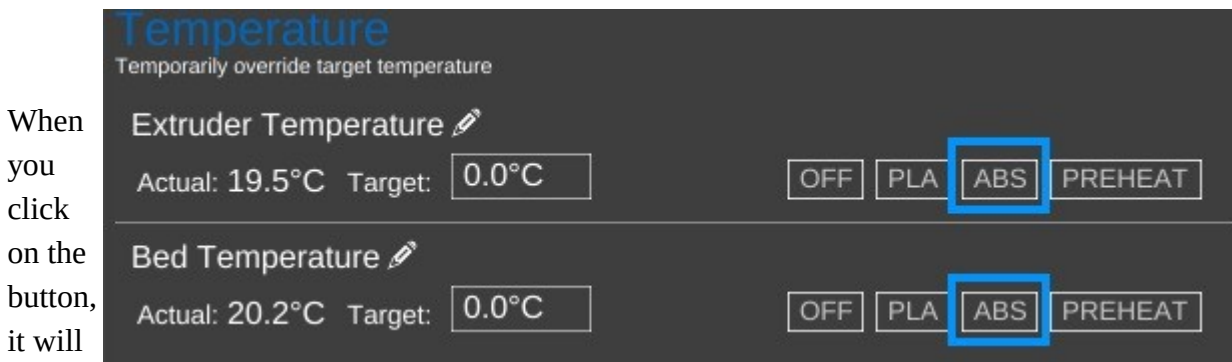

Fig. 19-33: Preheating the bed & hot end.

execute the script you just entered. The script will move the nozzle to 0.2mm above the center of the build plate and pause for five seconds. It will then move to the X tower, then the Y tower, then the Z

Rostock MAX v2 Assembly Guide

tower, and finally will return to center.

You may notice an odd “arc” motion as the nozzle travels from point to point. This is a mathematical phenomenon within the firmware and won't affect your calibration. You can safely ignore it.

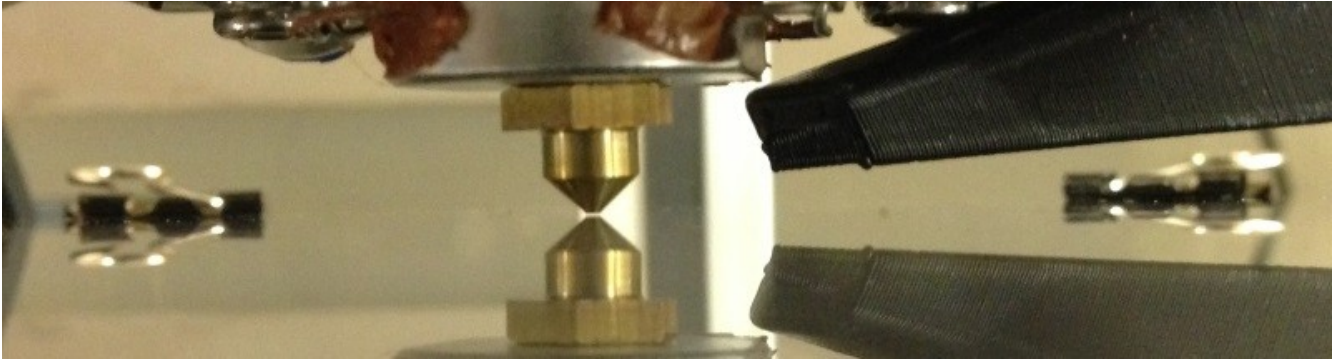

Fig. 19-34: Nozzle at the center, 0.2mm above the glass.

As the script runs, your focus should be on the nozzle where it pauses. You want to compare the gap at the tower base to the gap at the center.

If the nozzle at the tower base is higher at the pause point in comparison to the center, you'll want to turn the screw for that tower's end-stop counter-clockwise. Think “Turn Left to Lower”.

If the nozzle at the tower base is lower at the pause point in comparison to the center, you'll want to turn the screw for that tower's end-stop clockwise. Think “Turn Right to Raise”.

Repeat this process for each of the three axes. Adjust only a single axis at a time. Doing all three at once will make you crazy. Run the **Tower Cal** macro each time you make a change to an end-stop screw.

When you're done, you need to re-set the Z height as it will have changed due to the calibration process. Once you've re-set the Z height, run the **TOWER CAL** macro again. Pay close attention to the distance between the nozzle and the glass bed.

If from the center position, the nozzle goes *down* toward the glass at **all three towers**, you'll need to change the **Horizontal Radius** value in the EEPROM. Open up the EEPROM table editor and scroll down until you see the field marked below.

Diagonal rod length [mm]	269
Horizontal radius [mm]	130.25
Segments/s for travel	70
Segments/s for printing	180

Fig. 19-35: Horizontal Radius setting.

You'll want to **raise** this figure by 0.2. Run the **Tower Cal** macro after each change to check the effectiveness of the change.

If from the center position the nozzle goes **up** from the glass at **all three towers**, you'll want to **lower** the Horizontal Radius by 0.2. Run the **Tower Cal** macro after each change to check the effectiveness of the change.

After doing this, you will see any changes where one tower may be higher than the other. If this is the case, go back and re-adjust the end stop screws.

It can typically take anywhere from 5-10 iterations of the calibration process in order to get the gap to remain the same at all three pause points compared to the center point. Once the gap is the same at each tower compared to the center, the machine is calibrated and ready to print.

Verifying Extruder Stepper Operation

Go to the **CONTROLS** pane in MatterControl and click the “PLA” button that's in the “Extruder Temperature Override” box. The hot end needs to be heated in order to perform this next test. The reason for this is that the firmware is designed such that it will not permit extrusion if the hot end is cold.

Once the hot end has reached the target temp (190C in this case), click the “**E+**” button to extrude some filament.

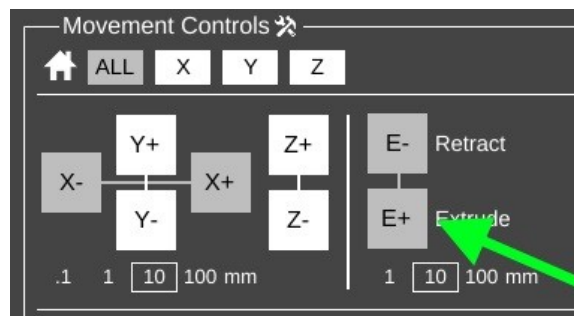

Fig. 19-36: Extrude Filament control.

Watch the knob on the extruder when you click that button. You should see the knob slowly turn counter-clockwise. If it's turning clockwise, you'll have to make a change in the firmware. It's a very simple change and you shouldn't have any problem at all doing it.

If you've got backwards-running stepper motor, you'll need to open the Arduino IDE and make a single change in Configuration.h. Look for the following line:

```
#define EXT0_INVERSE true
```

You'll find it on or close to line #195 in the file. Whatever the value is set to, invert it. If it's true, change it to “false”. If it's false, change it to “true”. Save your changes and then upload the firmware to the RAMBo. ***Make sure you've got MatterControl disconnected or the Arduino IDE won't be able to talk to the board.***

Extruder Calibration

The last task you'll need to perform before you can load plastic in to the machine is to correctly set the steps per mm (“E-Steps”) for the extruder. Open up the EEPROM configuration editor and look for the label highlighted below:



Fig. 19-37: Extruder steps per mm.

The value should be set to 92.65. If you're using the older Steve's Extruder, this value should be set to 584.

This value dictates the number of steps that the stepper motor must rotate in order to feed 1mm worth of filament to the hot end. The figure supplied will get your e-steps very close to ideal, but extra fine tuning should be done. I *highly* recommend that you check out the “E Steps Fine Tuning” section of Triffid_Hunter's excellent calibration guide. It can be found here:

Rostock MAX v2 Assembly Guide

http://reprap.org/wiki/Triffid_Hunter%27s_Calibration_Guide

The other portions of his calibration guide doesn't really apply to the Rostock MAX v2, so it's not necessary to read unless you're simply curious.

20 – First Print: PEEK Fan Shroud

For your first (and second!) prints, you're going to need to have ABS filament handy. This is because the PEEK and Layer fan shrouds can be exposed to temperatures that would turn PLA shrouds into a gooey mess. You're also going to need the 25x25x10mm PEEK fan itself.



Configuring the Slicer

The process of converting a 3D model into something you can print is called “slicing”. The

Rostock MAX v2 Assembly Guide

software used for this process is typically called a “slicer”. Essentially a slicer cuts up your 3D model into hundreds (sometimes thousands!) of tiny slices that are then converted into code that the printer controller can understand. MatterControl contains three slicing “engines”: Slic3r, CuraEngine and MatterSlice. I’m only going to cover the MatterSlice engine configuration for right now.

Head over to the SeeMeCNC download area - <http://seemecnc.com/pages/downloads> and scroll to the bottom of the page – you’re looking for the section marked “MatterControl Pre-Configured Slicing Profiles”. Click on the MatterControl Rostock MAX link to download the file. When complete, unzip it into a directory you can easily find again. When you’ve got the file unzipped, click on the Toolbox icon next to the “QUALITY” label.

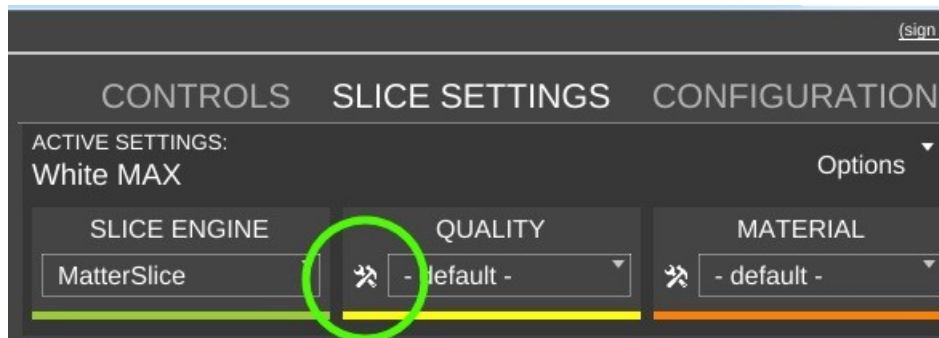

Fig. 20-1: The Toolbox icon.

When the **Quality Presets** window opens, click on “**Import**” as indicated below.

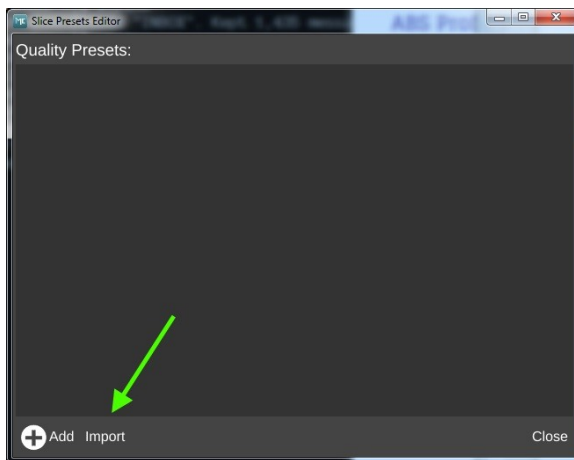

Fig. 20-2: Import!

When you click on **Import**, you’ll be able to navigate to the location where you unpacked the MatterControl per-configured profiles. Go into the **QUALITY** directory and select the “STANDARD.slice” file. When the file is loaded, the **Quality Presets** window will look like Fig. 20-3 below.

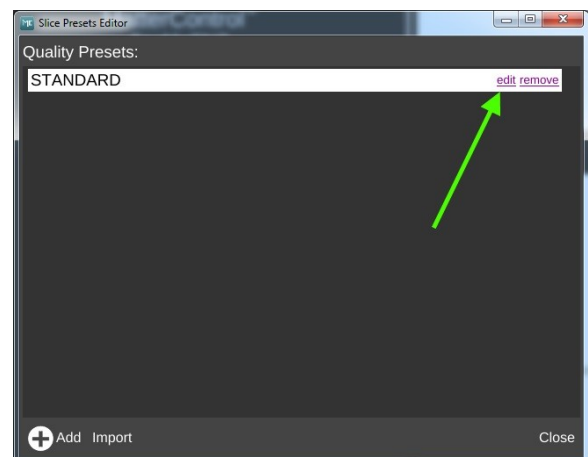

Fig. 20-3: Standard profile loaded.

Click on “**edit**” to open up the preset editor.

Once the **Presets Editor** opens, simply click on **Save** to commit the changes you just loaded. This will dismiss the **Presets Editor** and you can then click **Close** on the **Quality Presets** window.

Now click on the **Toolbox** icon for the **MATERIAL** column.

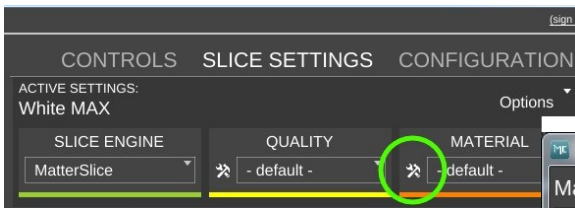

Fig. 20-5: Materials Toolbox.

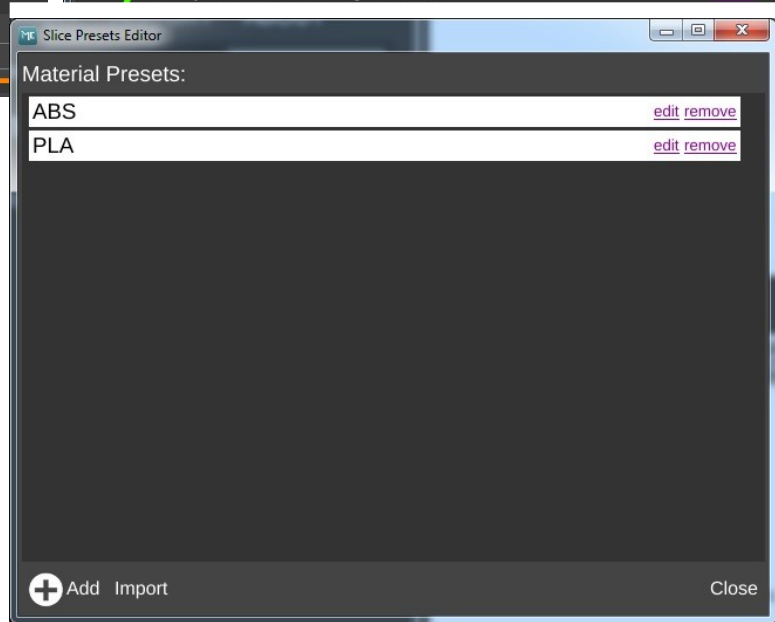
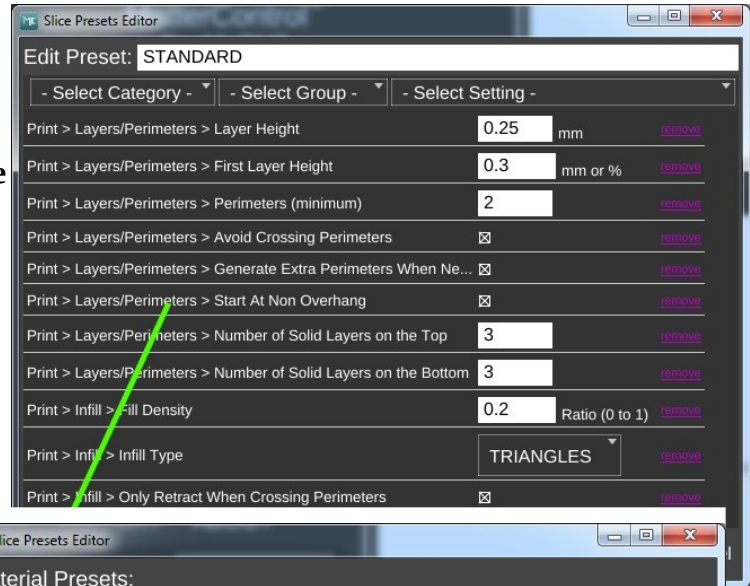

Fig. 20-6: Material presets loaded!

You're going to follow the same steps you did for the **QUALITY** preset, but this time you're going to go into the **MATERIALS** directory and import the file named "ABS.slice". This will bring in the defaults needed for your first print with ABS. You might also want to load the PLA configuration at this time.

Rostock MAX v2 Assembly Guide

Before you can begin your first print, you're going to customize your first material profile!

Click on the Toolbox icon for the **MATERIAL** column and click the edit field for the ABS configuration. When the **Presets Editor** window appears, click on “**Duplicate**”. This will create a new preset called “ABS (copy)”.

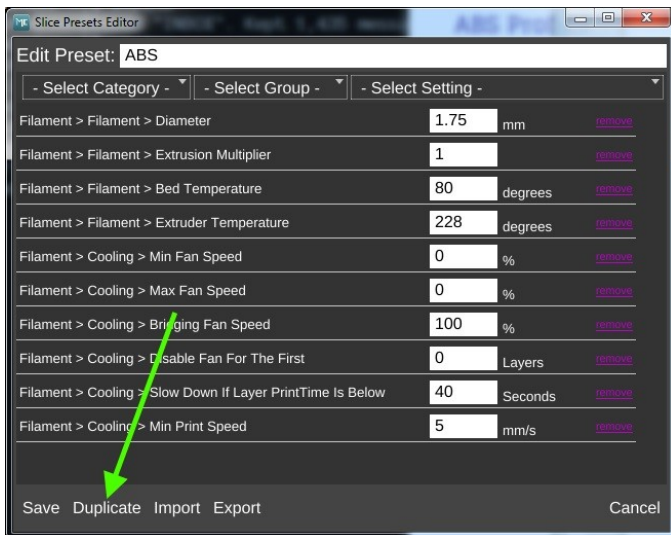

Fig. 20-7: Duplicating a preset.

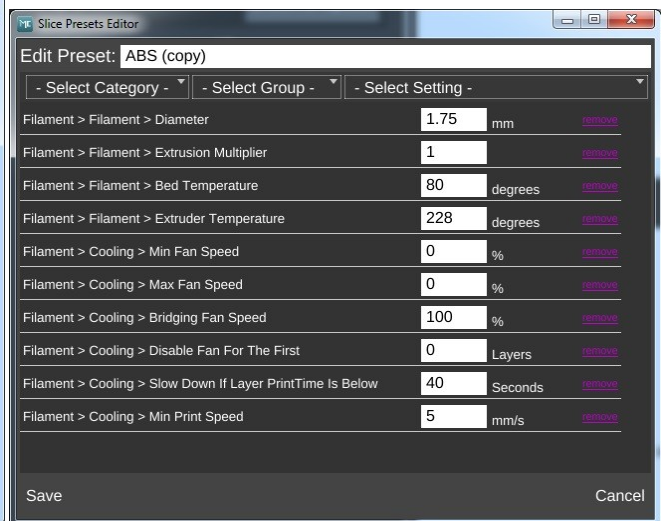

Fig. 20-8: Copied preset.

Click in the box that holds the name of the profile and change it to something that's descriptive of the material. Since I'm using a navy blue ABS filament I got from SeeMeCNC, I'm naming this preset “SeeMeCNC Navy Blue ABS 1.75”

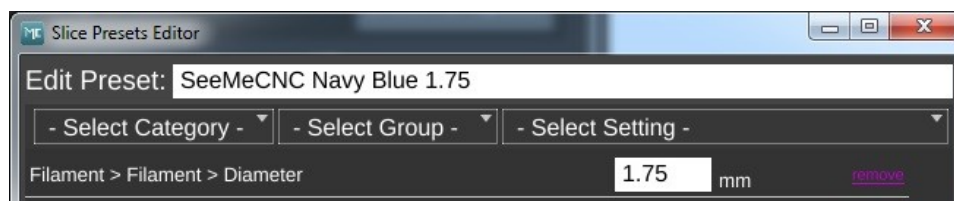

Fig. 20-9: A new material preset!

Now before you can save your new preset, you need to get a good idea of the actual diameter of your filament. This is important to know in order to get good print results.

I want you to cut off about 2 meters of filament from the spool you're going to use to print the fan shroud. Using your digital caliper, take 5 measurements along the length and record each one. When you're done, calculate the average filament diameter and put that figure into the Diameter size

Rostock MAX v2 Assembly Guide

field. It may be less than 1.75mm, but shouldn't be any more than 1.8mm. If you have any measurements of 1.8mm or greater on your filament, it may bind in the hot end. In my case, the filament average was 1.72, so that's what I entered.

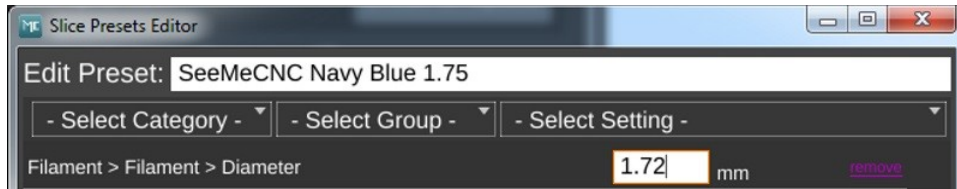

Fig. 20-10: Updated filament diameter.

After you've updated the filament diameter, click **Save** to commit your changes. When the editor window is dismissed, you'll see your new material preset in the list!

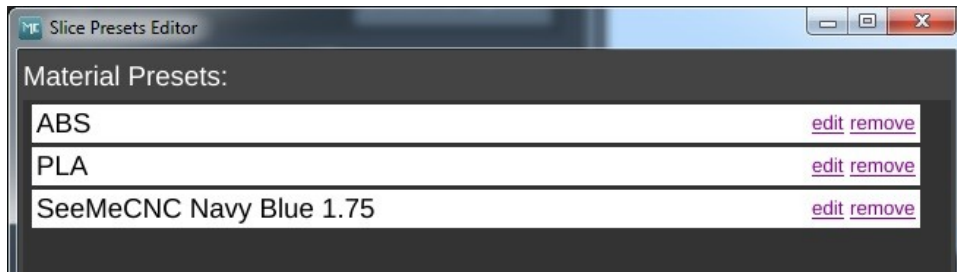

Fig. 20-11: New material preset!

Click **Close** to dismiss the **Presets Editor** and we'll move on to the next step, printing your first part!

Printing The PEEK Fan Shroud

If you downloaded the MatterControl presets file, you can skip downloading the file from Repables.

Go here: <http://repables.com/r/140/> and click the “Download” link. When the download is finished, unzip the file. This is the STL file that MatterSlice will process and turn into your first print!

When you've got the file downloaded, you can load it into MatterControl by clicking on the “**Add**” button and selecting the STL file you want.

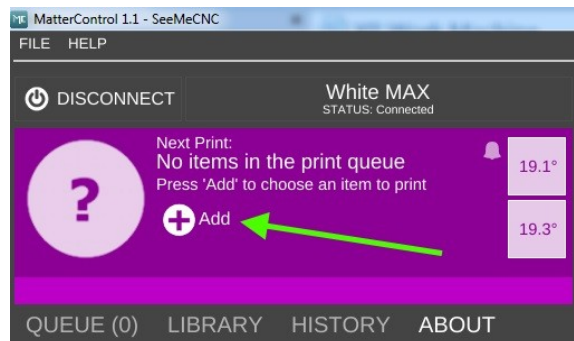

Fig. 20-12: Loading an STL file.

Once the open file dialog opens, navigate to where you unpacked the file. If you downloaded the MatterControl presets file, the PEEK fan shroud file will be found in the “STLs to include” directory. It's called “70766 EZFan Shroud r2.stl”

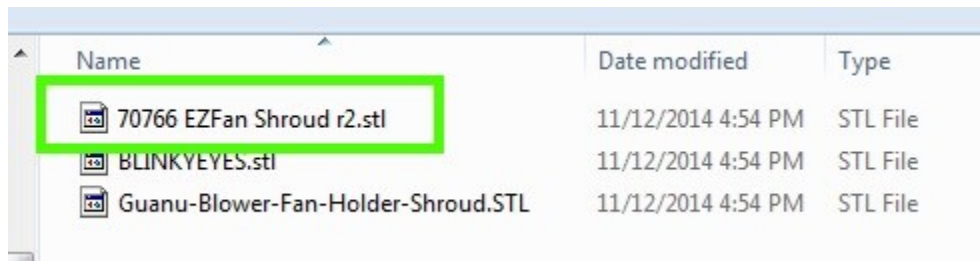

Fig. 20-13: The PEEK fan file.

Now that you've got the file loaded, we need to load filament into the printer!

Loading Filament

It's extremely simple to load filament into the EZStruder. Just place your index finger on the top of the extruder and your thumb on the tension lever (marked by the arrow below). Press the tension lever down and feed the filament by hand along the path marked by the green arrow. There is a small opening behind the tension lever that the filament will enter into the extruder through.

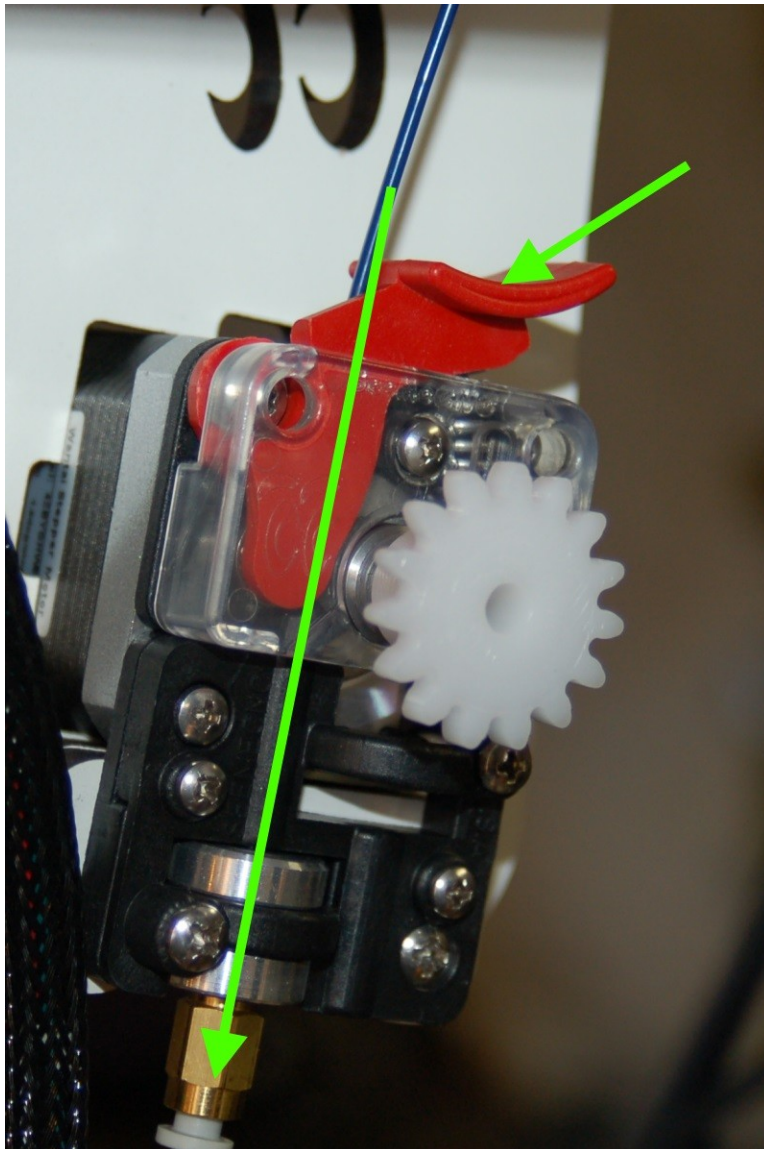

Fig. 20-14: Loading filament.

Continue to manually feed the filament until it passes through the other push-fit connector on the hot end.

Now you'll need to heat the hot end in order to prime it with filament. Once the hot end reaches the target temperature, I want you to start using the manual Extrusion button to feed filament into the hot end.

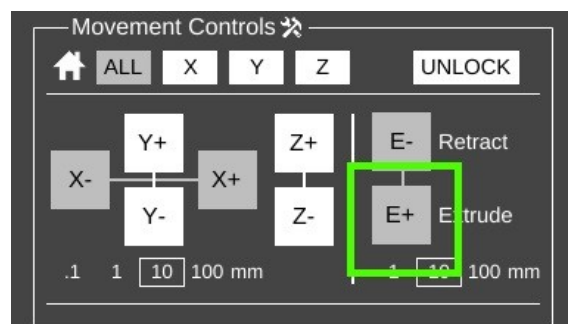

Fig. 20-15: Extruder control.

Rostock MAX v2 Assembly Guide

In the figure to the right, you'll see the control panel for the extruder. In order to safely feed the hot end, make sure that you've selected "10" in the settings below the E+ button. Click the E+ button to begin feeding filament through the hot end. You may have to click the button a number of times to get filament coming out of the hot end, but you'll want to wait for the extruder to stop moving before you click it again.

Once it does begin to feed, go ahead and click the E+ button a few more times just to get the extruder all nice and primed.

I recommend that you extrude 20-30mm of filament each time you start up the printer for the day. This ensures that the hot end is primed and you have no jamming issues.

Preparing the Heated Bed

ABS won't stick to bare glass. In order to get the ABS to stick, you're going to need to apply two thin layers of glue to the bed. Remember back in the "need to have" list, I listed the Elmer's "Disappearing Purple" glue stick? This is where you're going to use it.

You'll want to apply two perpendicular layers of glue on to the heated bed. Follow the simple pattern in Fig. 20-16. The green lines represent the first layer and the red lines represent the second. The idea is to lay down a thin, even layer with no spaces between each "lane" of glue. Let the base layer completely dry before applying the second layer. Let THAT layer dry before starting a print.

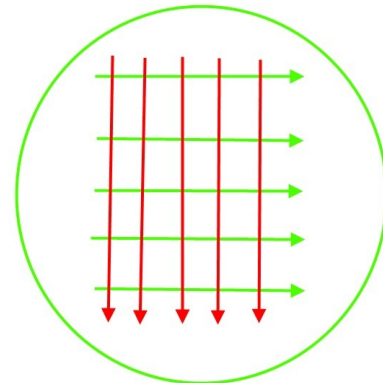

Fig. 20-16: Glue application.

Printing the PEEK Fan Shroud

Check on the **Slice Settings** pane to make sure that you've got "MatterSlice" chosen for the slice engine, "STANDARD" chosen for Quality, and "ABS" chosen for Material. ***Make sure that the filament you have loaded in your printer IS ABS! Running PLA at ABS temperatures without the PEEK fan installed will cause the hot end to jam!***

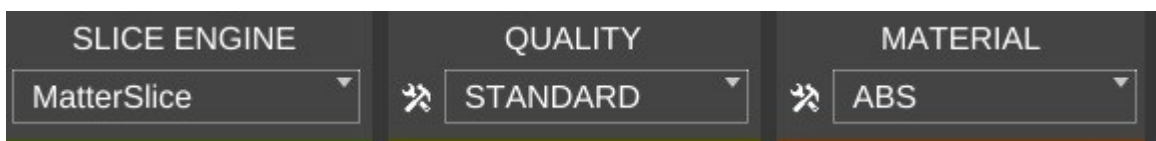

Fig. 20-17: Correct slice settings.

Now that you've gotten everything loaded and prepped, starting the print is as simple as clicking

Rostock MAX v2 Assembly Guide

on the “**Start**” button.

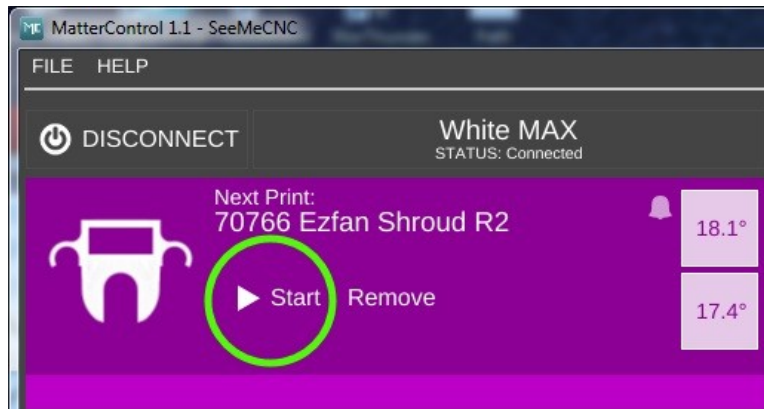

Fig. 20-18: Starting the print job.

When you click the **Start** button, the hot end and the heated bed will begin to heat. The hot end will reach its target temperature first because it has much less mass to heat than the heated bed. The heated bed can take up to 10 minutes or so to reach its target temperature.



Fig. 20-19: Heating up!

Once both the bed and hot end are hot, the printer will home and the print job will begin!

Right before the printer begins to print, the RAMBo controller will “chirp” the LCD speaker and you’ll see a text warning on the LCD controller to keep your hands away. There will be a short delay after this and the print job will begin!

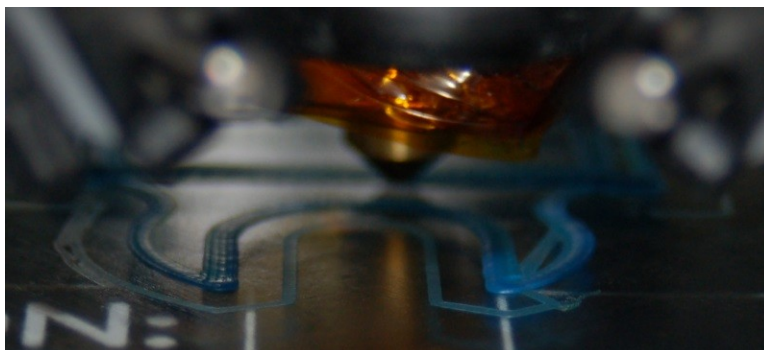

Fig. 20-20: The first layer.

The print will take roughly an hour to complete. When the job finishes, MatterControl will issue a bell sound and the machine will home itself. (It's actually more of a “Hey! YOUR TOAST IS DONE!” dinging sound, but you get the idea...)

To the left is a photo of the PEEK fan shroud I printed. It's got a few defects, mostly due to a slight amount of over-extrusion. As you get more familiar with the Rostock MAX v2 and 3D printing in general, you'll learn how to fix issues like this to get excellent prints!

After the print job is complete, the power to the hot end and the heated bed will be turned off. When the heated bed reaches around 40C, you'll probably hear a cracking sound as the part separates from the bed.

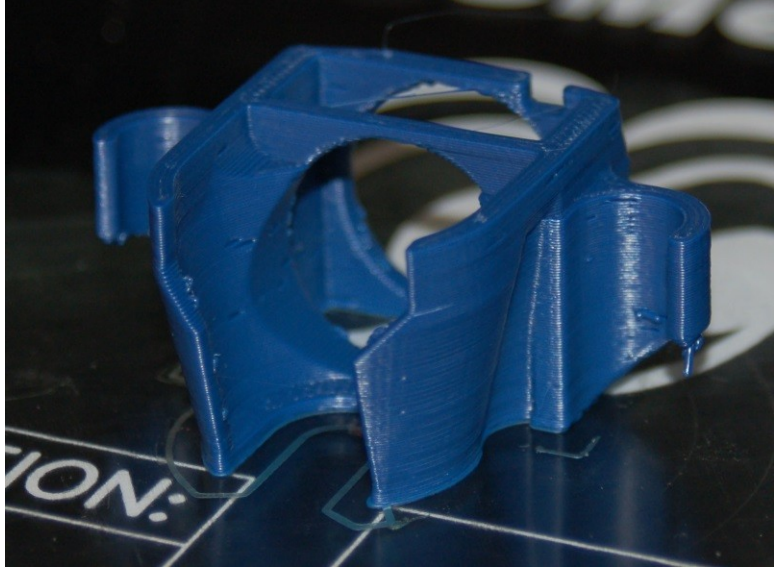

Fig. 20-21: Completed PEEK Fan Shroud.

Even if you don't hear this sound, the part should come free of the bed pretty easily after the bed has had a chance to cool.

Installing the PEEK Fan and Shroud

Before you can install the PEEK fan shroud, you're going to have to wait for the hot end to cool to room temperature. You don't want to burn yourself while installing the shroud.

While you're waiting for the hot end to cool down, go ahead and install the 25x25x10mm fan into the shroud. I'll warn you right now – it's going to be a VERY tight fit. The issue is that the fan is manufactured to a bit of a larger size than it's nominal 25x25x10 size indicates. One of the issues this presents is that the thin walls of the fan frame can deform and prevent the fan blades from moving. This can be solved by sanding just a tiny amount from the sides of the fan as shown below.

Rostock MAX v2 Assembly Guide

It looks like I removed a lot of material, but it's really only about 0.25mm.

Take a little off at a time and check for fit each time. You'll eventually reach a point where you can blow on the fan blades and they'll spin without striking the inside wall of the fan frame itself. Take care not to remove too much at one time – you don't want the fan to be loose in the shroud.

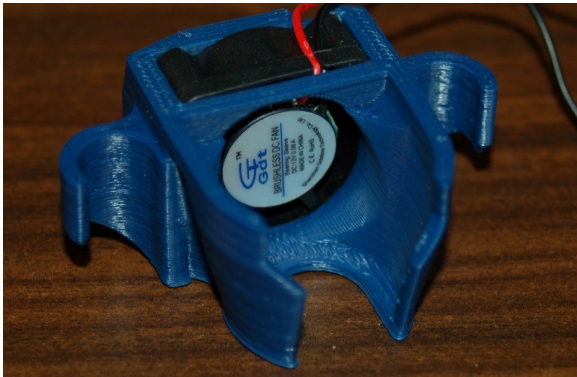

Fig. 20-23: Fan installed, inside view.

Make sure you've got the fan oriented exactly as shown. You want the label of the fan facing the space where the hot end will be. The power wires for the fan should rest in the notch provided.

You also want to make sure that the fan is fully seated. The fan shroud fits between the effector platform and the hot end mount.

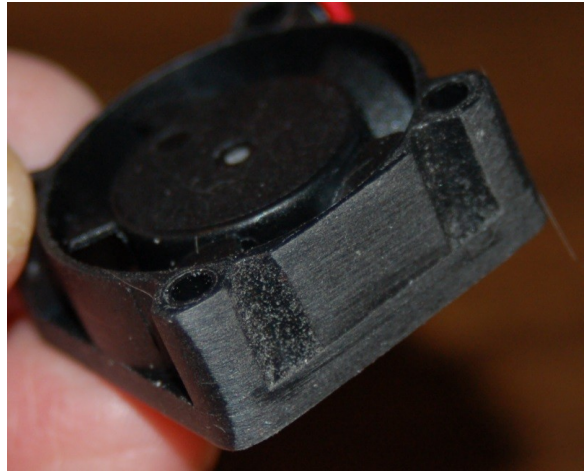

Fig. 20-22: Thinning down the fan.

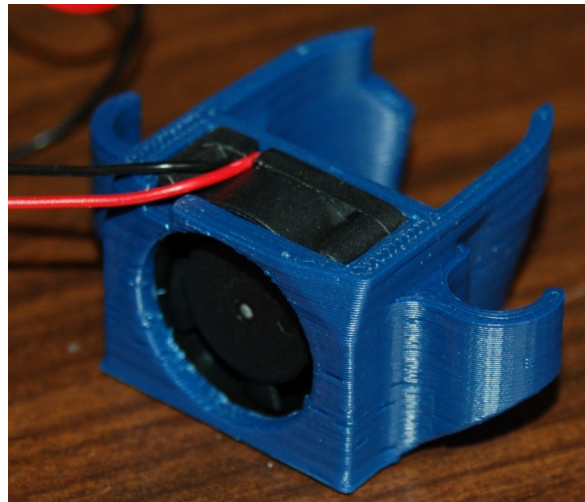

Fig. 20-24: Fan installed, outside view.

Remove the delta arms from the effector platform so you can more easily work on the hot end.

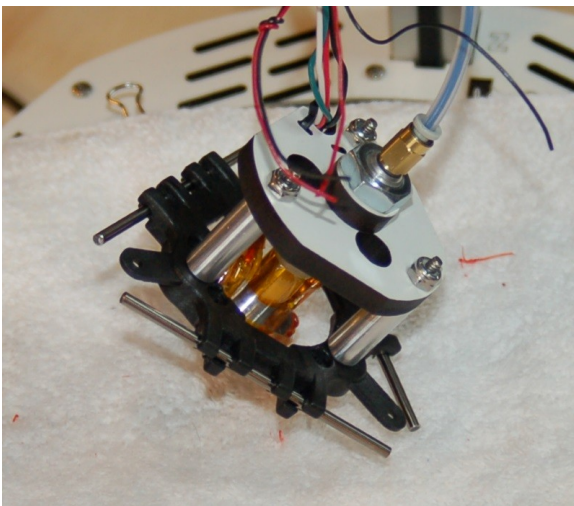

Fig. 20-25: Ready to install the PEEK fan!

Now loosen two of the hot end mounting screws as shown in Fig. 20-26.

Rostock MAX v2 Assembly Guide

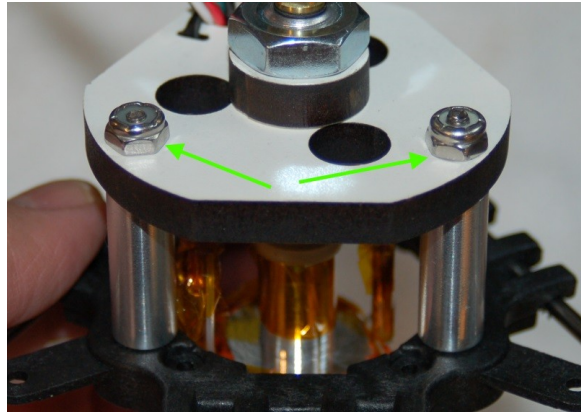

Fig. 20-26: Loose screws. (But you knew that, right?)

Make sure that the hot end is turned such that the sides of the PEEK fan shroud can go to either side of the hot end body, but not trap a wire between the shroud and the hot end. You do NOT want wires jammed against the hot end by the fan shroud! When you slide the fan shroud into place, the “arms” should come in full contact with the 1” aluminum spacers to either side.

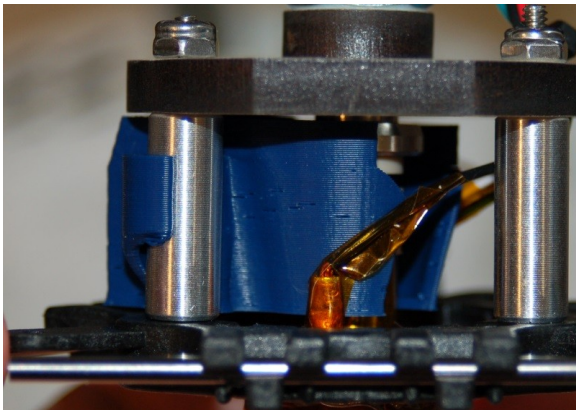

Fig. 20-27: Side view of fan shroud installation.

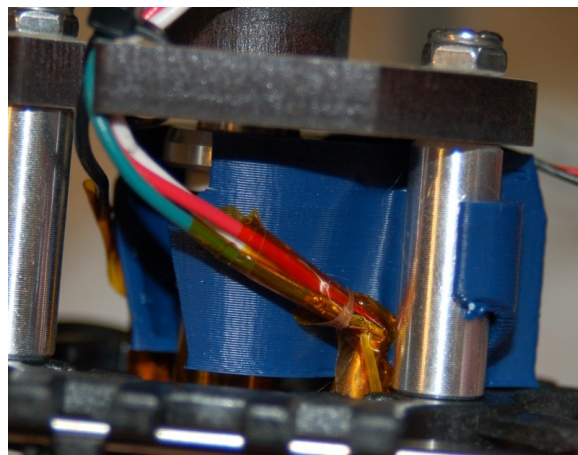

Fig. 20-28: Another side view...

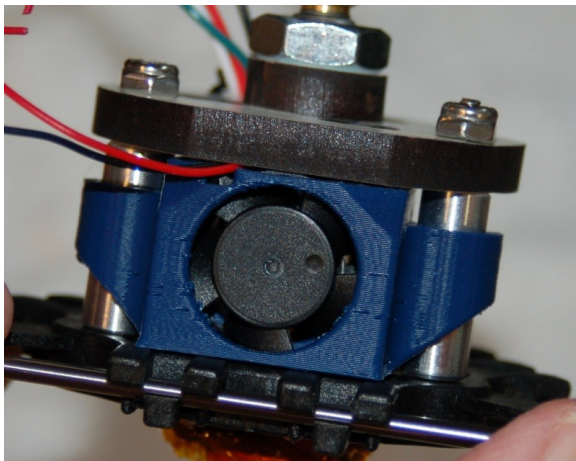

Fig. 20-29: What is it with all these angles?

Now tighten down the two screws you loosened in order to install the fan and attach the fan leads to the knotted pair of 26ga wires coming

Rostock MAX v2 Assembly Guide

from the wiring loom as shown below. Take care to ensure that you don't accidentally pinch the power wires between the top of the fan shroud and the bottom surface of the hot end mount!

Don't forget to cover your soldered joints with Kapton!

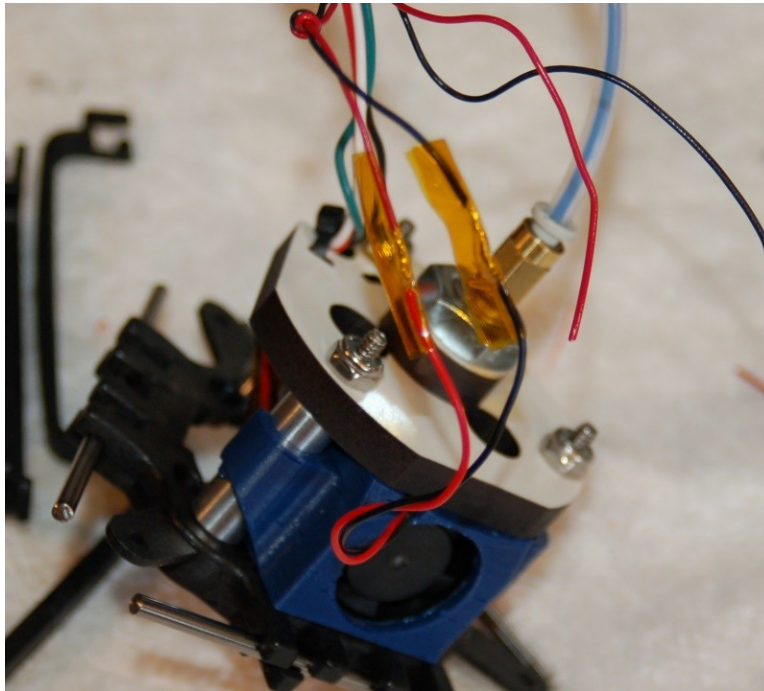

Fig. 20-30: All wired up and ready to be...cool.

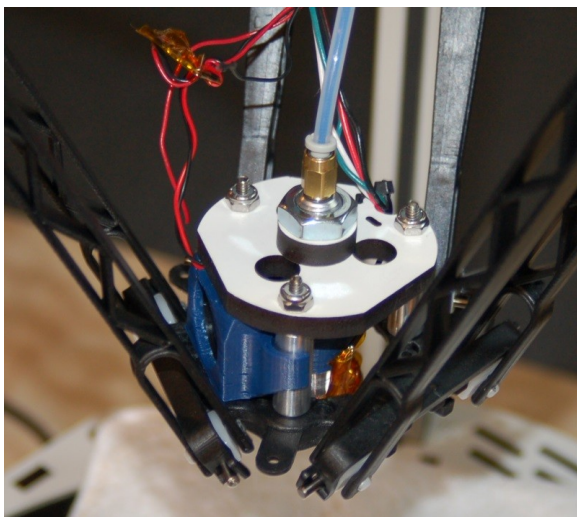

Fig. 20-31: All back together.

Now re-install the arms on to the effector platform. Don't forget to make sure that the u-joints are installed with the ejector pin marks facing away from the effector platform!

The PEEK fan shroud is “virtually” linked

Rostock MAX v2 Assembly Guide

to the hot end power. You should be able to see the fan running as soon as you start heating the hot end. Do that now to make sure the fan operates. When you run a print job, the PEEK fan will continue to run even after power has been removed from the hot end. It will continue to run until the hot end temperature falls below 50C.

After you've got the PEEK fan installed, please re-run the auto-tune PID routine for the hot-end. The running PEEK fan will have changed the heating profile and the PID variables need to be updated in order to account for this change. To give you an idea of how much it can change, my PID values prior to installing the PEEK fan was 10.89, 0.49, and 59.81. After the PEEK fan was installed, the PID values changed to 17.98, 1.12, and 72.23. Note that your PID values may be no where near the values I show here. This is perfectly normal. The PID values calculated depend on many factors, including room temperature at the time of tuning, variances in resistor position, etc. There are no “correct” PID values, just “usable” ones. :)

21 – Second Print: Layer Fan Shroud

If you plan on printing in PLA or other materials that can benefit from a cooling fan (NOT ABS!), you'll want to print the layer fan shroud. The layer fan model can be downloaded from Repables, <http://repables.com/r/212/>. If you grabbed the PEEK fan shroud file from the zip file that contained the default slicer settings for MatterSlice, you want to add the file named “NEW2Guanu-Blower-Fan-Holder-Shroud.STL” to your print queue.

Rostock MAX v2 Assembly Guide

It's specifically designed to mount on the newly redesigned effector platform and the included 30mm squirrel cage fan.

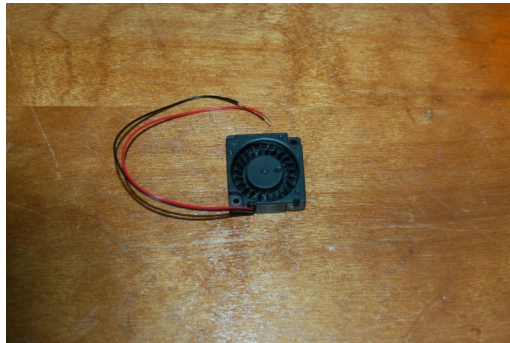

Download, extract and load the layer fan model into MatterControl, just as you did for the PEEK fan. The printing parameters are the same. Make sure you've got the same slicing configuration you used as last time and hit the **Start** button!

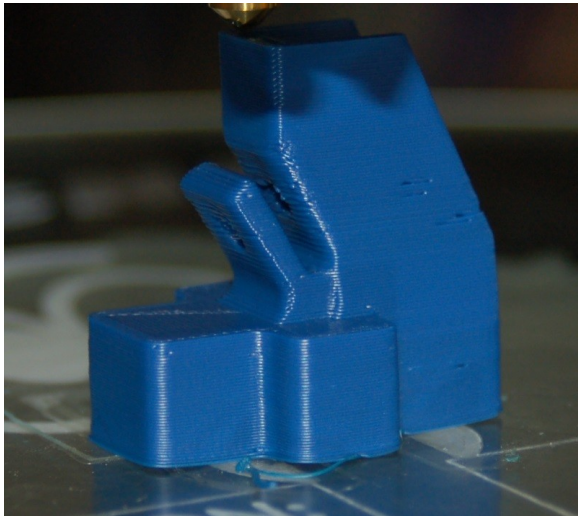

Fig. 21-1: Looking good!

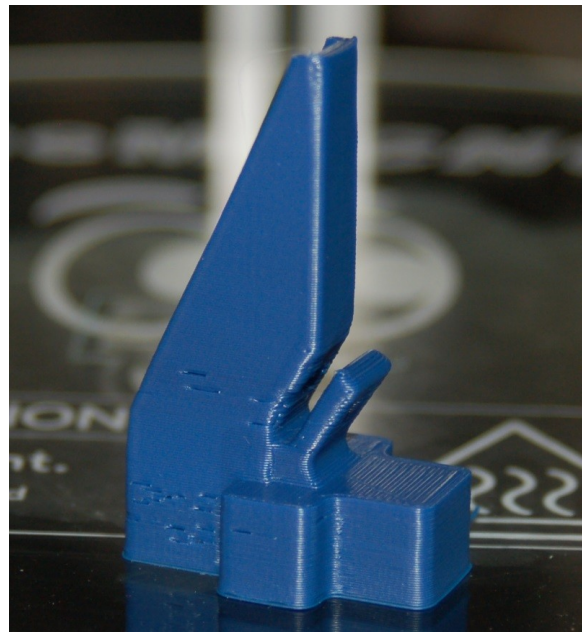

Fig. 21-2: Completed layer fan shroud.

When you're able to remove the part from the print bed, insert the tiny squirrel cage fan into the shroud as shown below.

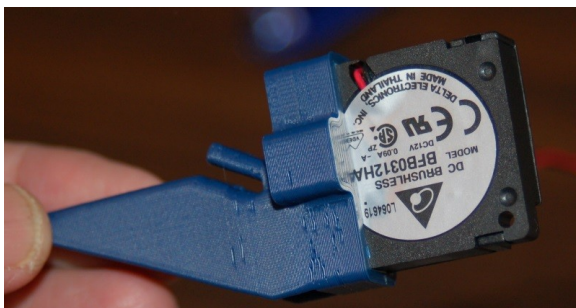

Fig. 21-3: Left side view.

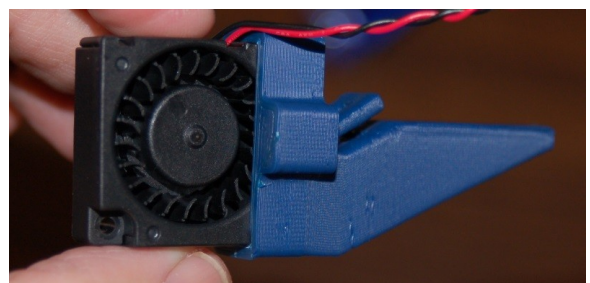

Fig. 21-4: Right side view.

Rostock MAX v2 Assembly Guide

The effector platform provides three mounting locations for the layer fan. Yes, you can install three of them if you really want. :)

With the machine powered off, slide each Cheapskate down to the base of the tower so that your hot end is at the top of a pyramid formed by the three arms. Lay a washcloth or towel on your heated bed to protect it while you're working on the hot end.

Choose a mounting point and test fit the shroud. It should be a snug fit, but if it won't fit at all, you may need to lightly sand it with a fingernail file.

Leave the fan sitting at the position you chose and solder the fan leads to the last remaining 26ga wire pair coming out of the mesh loom. Cover the solder joints with Kapton tape and use a #4 machine screw to fix the fan shroud into place.

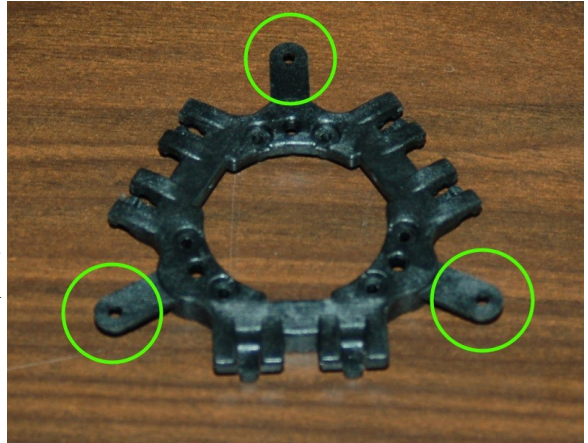

Fig. 21-5: Layer fan mounting points.

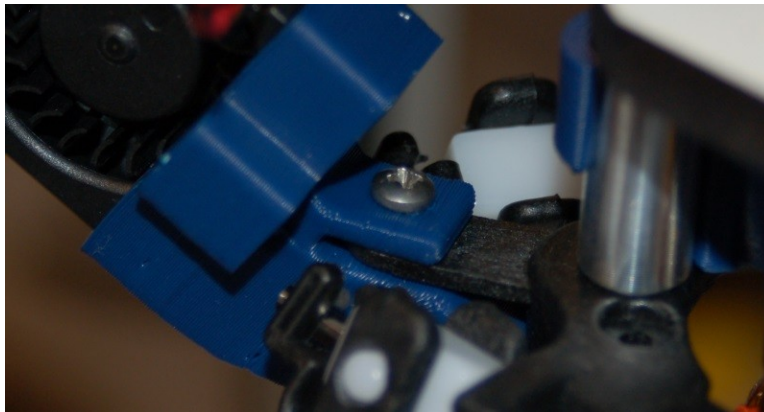

Fig. 21-6: Layer fan & mount installed.

Before you return the hot end to its operating position, turn on the printer and connect MatterControl to it. You're going to test the fan to make sure it works and the fan blades don't rub on the shroud.

Click on the **Controls** pane and then set the fan speed to 100% by clicking on the box next to the "Fan Speed:" label and then enter "100" followed by pressing ENTER or clicking the "Set" button.

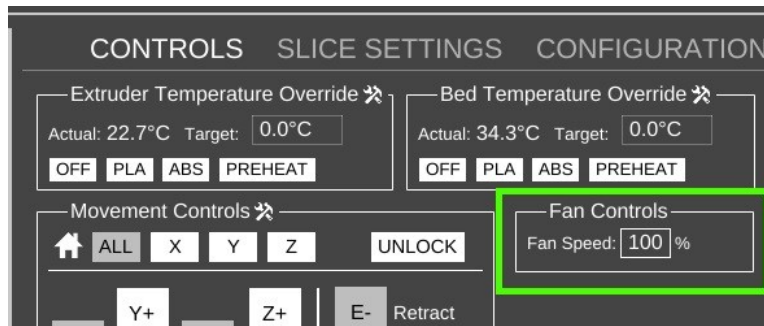
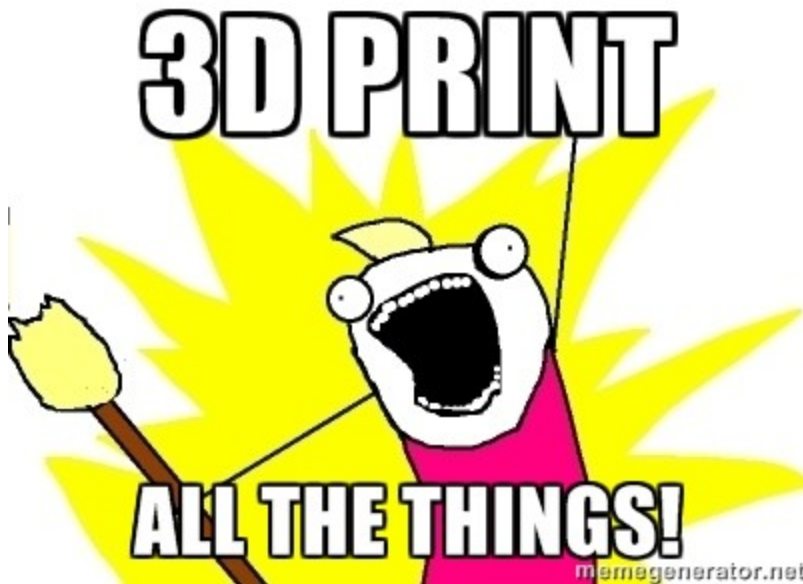

Fig. 21-7: Running the layer fan.

The fan should start running at full speed. Make sure that it's spinning the correct direction by holding your hand under the fan shroud to check for moving air. If it's not blowing air, you've likely connected the wires backwards. :) Correct it and try again.

To turn the fan off, just click in the fan speed box and enter "0" followed by ENTER or click on the "Set" button.

With the installation of the layer fan, your Rostock MAX v2 is *totally* complete and you may now...



22 – Matter Control Basics: Slicing

MatterControl is a very complete 3D printing package and it's got a LOT of options. Some people can find this intimidating, but I assure you – there's nothing to be worried about!

MatterControl is an integrated host application. This means that it provides everything needed to control the Rostock MAX and to prepare models for printing. The task of preparing a model for

Rostock MAX v2 Assembly Guide

printing is called “slicing”. It's a very descriptive term for what is actually happening. In order to print a 3D model, it needs to be converted from a solid object into a series of very thin layers that are in turn converted into G-Code (more on this later). For example, if your print layer height is 0.2mm, the slicing tool is going to “slice” your model into a number of layers – basically the model height divided by 0.2mm. For a tall part, this can mean a LOT of layers!

MatterControl provides three slicers for your use. MatterSlice, CuraEngine, and Slic3r. This guide will only cover the specifics of MatterSlice, but don't let that stop you from experimenting with and using the other slicers! I'll show you how to change the slicing engine later on in this guide.

The final task of the slicer is to translate the sliced layers of model into something called G-code. G-code is a simple control language that's used to position the print head and tell the extruder how much plastic to deliver and at what rate. Going into the details of G-code is beyond the scope of this guide, but if you'd like to learn more you can check out the following resources:

<http://en.wikipedia.org/wiki/G-code> and <http://reprap.org/wiki/G-code>.

For the most part, you'll never directly interact with G-code, but it's nice to know what's going on behind the curtain!

I want you to click on the **Advanced Controls** button to bring up the **Settings, Controls, and Configuration** pane.



Fig 22-1: Menu Bar.

Rostock MAX v2 Assembly Guide

Click on the **SETTINGS** link to make sure your display follows (by and large) what you see below.

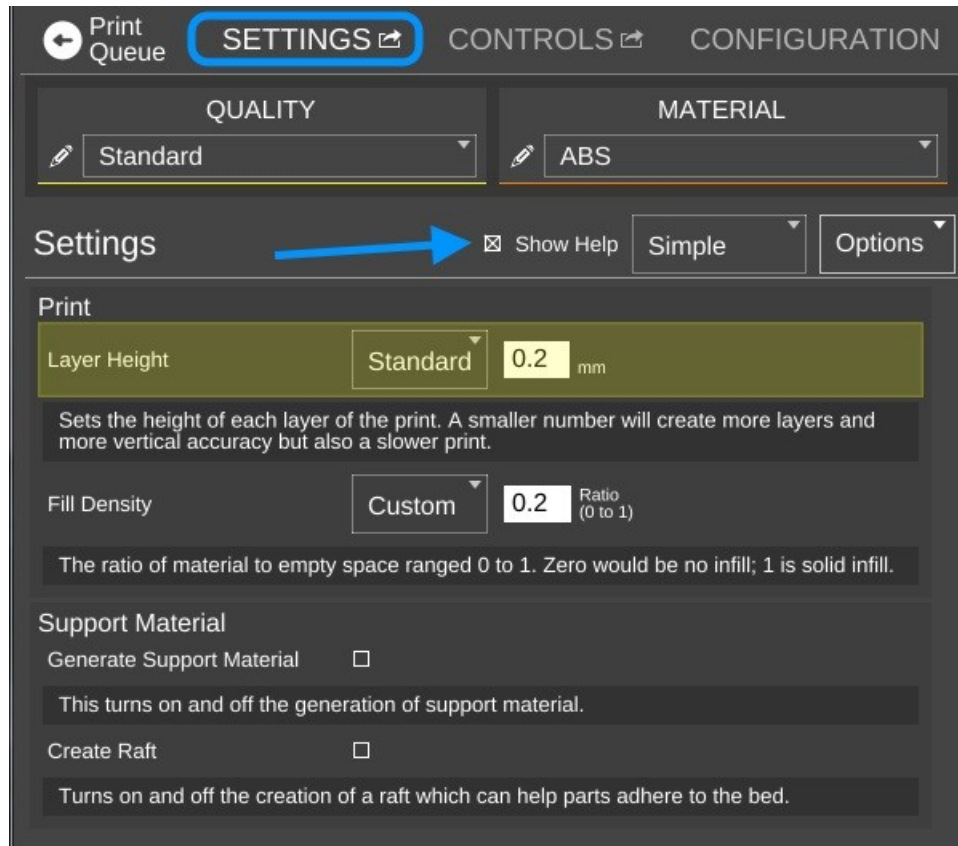

Fig. 22-2: Settings Pane.

The first thing I want you to do is click on the **Show Help** check box that's highlighted by the arrow in the image above. This will turn on verbose descriptions of each one of the parameters available in the Settings page.

I'm going to only cover the “Simple” configuration settings for right now. There's a LOT that goes on to configuring your slicer and the Simple configuration setting allows many of those to be hidden until you're more comfortable with how your printer works.

Layer Height – This parameter tells the slicing engine how thin to make the layers when it slices up the model as I described earlier. A good default layer height is 0.2 or 0.25mm. The lowest practical layer height with a 0.5mm nozzle is 0.1mm. You can go lower than that, but it requires a smaller nozzle diameter. You can also get a lot thicker, but that requires a larger nozzle. If you change the Quality from **Standard** to **Coarse** or **Fine**, you'll notice how the layer height changes.

Here's what the **Coarse**, **Standard**, and **Fine** layer heights look like when printing the little test cube in ABS plastic.

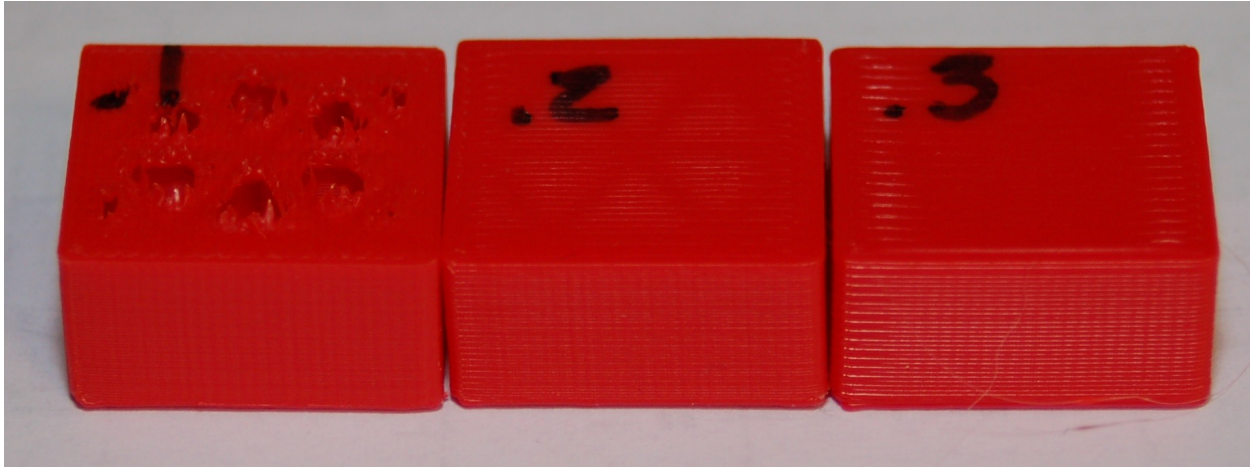

Fig. 22-3: Layer height examples.

Starting from left to right, the layer heights are 0.1mm, 0.2mm and 0.3mm. You'll notice that the top layer on the 0.1mm print is kind of ratty and torn up. This is because the number of top layers is set to 3. This is perfectly ok with thicker layer heights, but it should have been set to at least 5 for the 0.1mm layer height that the **Fine** setting uses. You'll learn how to tweak that in a little bit.

You can see how the smoothness of the sides decrease as the layer thickness increases. If you want to print something really quick, you could go up to a 0.35mm layer height. I wouldn't recommend anything over 0.40mm if you're using a 0.5mm nozzle however.

Fill Density – This parameter controls how solid your printed part is. The number is a percentage, from 0 (totally hollow) to 1 (totally solid). The default fill density (also known as “infill”) is 0.2 or 20%. The image below shows what that looks like inside our little test cube.

You can tweak the infill to get a more robust or a lighter part. For most prints, 20% is a good infill value.

Later on I'll show you how to change to a different infill pattern. The one shown on the right is the Triangle pattern.

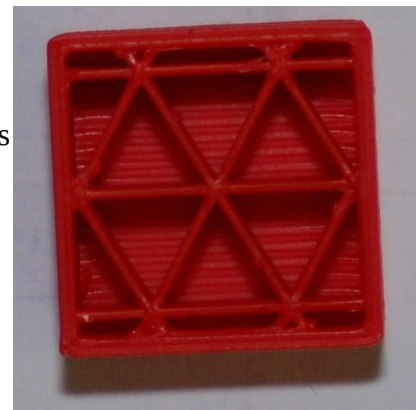

Fig. 22-4: 20% infill example.

Support Material – Support material is used when the part you're printing has free-standing features (like the chin on a bust) or another feature that requires it to be physically supported during the printing process. When you check the **Support Material** box, the slicer will automatically design support for the part that's currently (or will be) loaded.

Rostock MAX v2 Assembly Guide

Create Raft – A raft is essentially what it says, a “raft” of material that your part will print on top of. Rafts are most often used when printing a part that is having bed adhesion problems due to its geometry. For example, if you're printing a part that sits on small feet, a raft would come in handy if the initial layers of the feet don't stick very well.

In the image below, you'll see an example of both support material and a raft.

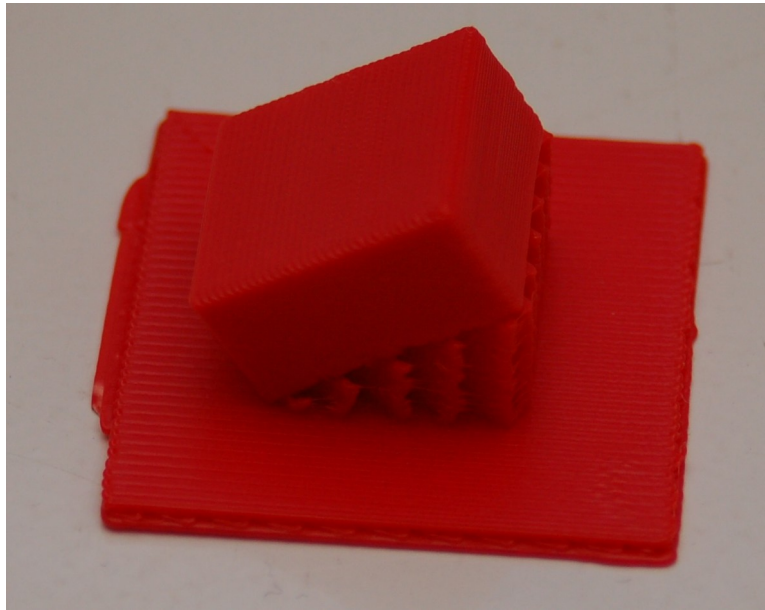

Fig. 22-5: Support material and raft.

I took the little test cube and through a little manipulation, printed it tilted at 30 degrees. I took this opportunity to also demonstrate what a raft looks like. This one is exaggerated in its size, but gives a great example of what a typical raft will look like.

The image to the right should give you a pretty good idea of what the part looks like from the side. You can easily see the support material as well as the

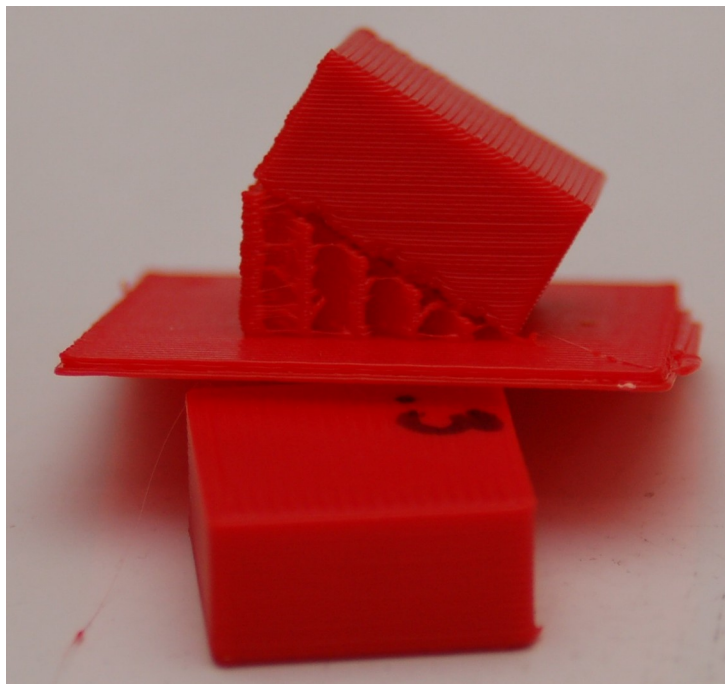

Fig. 22-6: Support & Raft.

Rostock MAX v2 Assembly Guide

layer lines that will be at a 30 degree angle when the little cube is laid flat.

Support material is generated in such a way that there is just enough of it there to handle the actual print layer that it will be supporting. In my example, the support material has a 2.5mm spacing between the walls of support material and it uses an infill angle of 45 degrees.

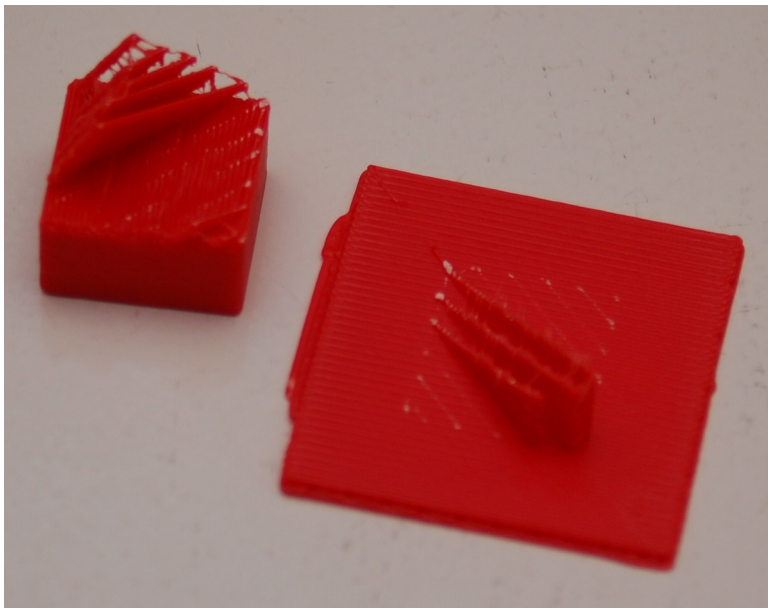
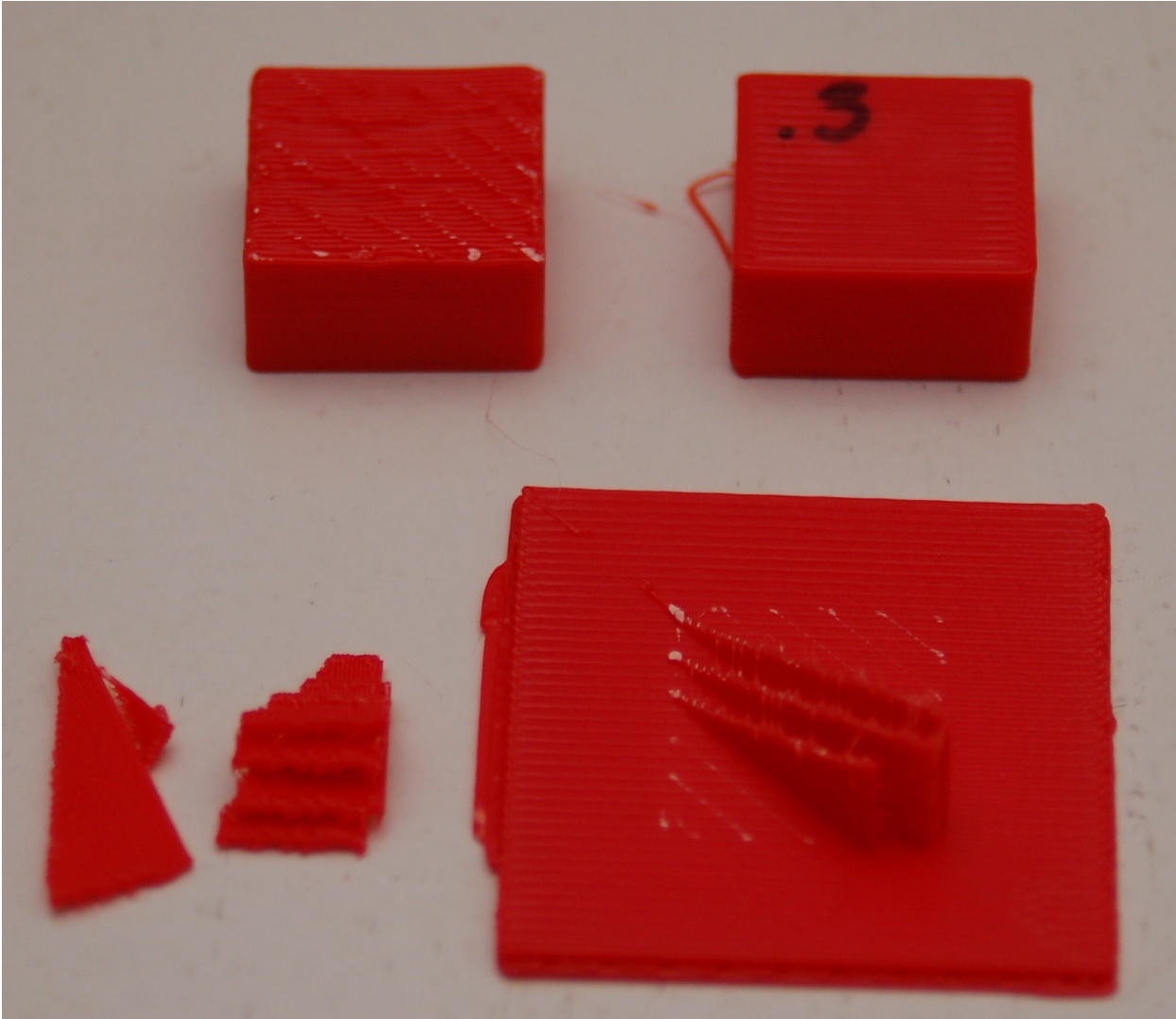

Fig. 22-7: Part separated from the raft.

The printed part will usually separate from the support material fairly easily – however, some material will be left behind if you're using a raft. Cleaning up the left over support material is a simple and straightforward task.

Rostock MAX v2 Assembly Guide

Here's what you end up with after removing the support material from your part. As you can see, there's still a little clean up to be done to the printed cube (on the left). A quick hit with some 220 grit sandpaper will knock the rough edges of the support material down.



That's pretty much all there is to the

Fig. 22-8: Part cleanup.

Simple settings level. Next, let's dig into the **Intermediate** setting!

Click on the **Simple** setting drop down and pick **Intermediate**. Your MatterControl settings screen should change to something resembling the image below.

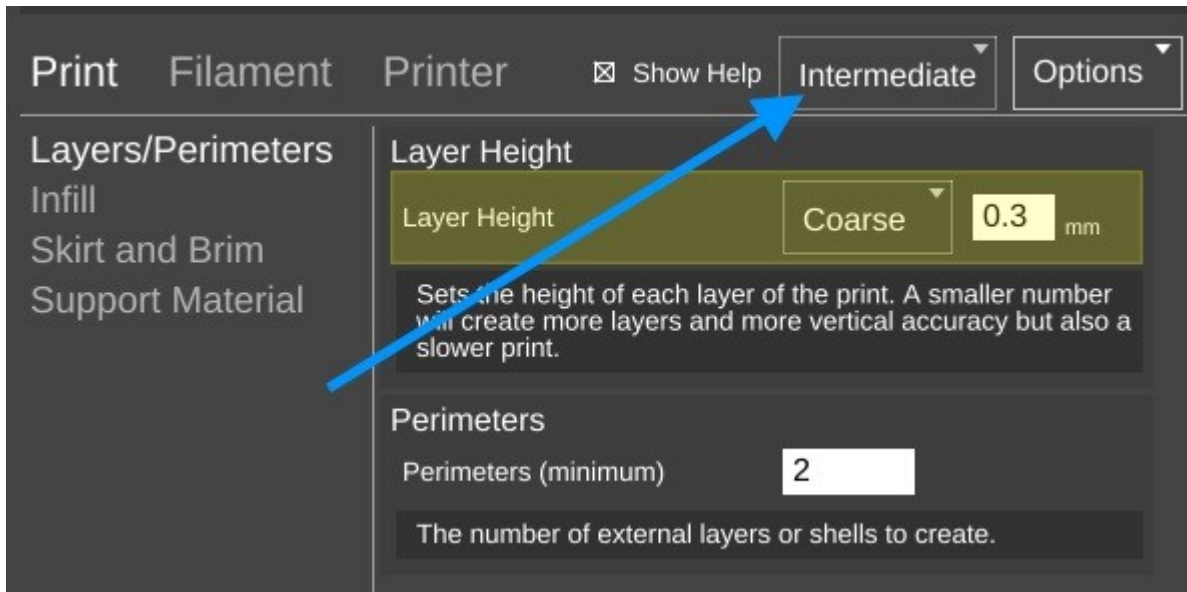

Fig. 22-9: Intermediate Settings.

Quite a number of new configuration options are accessible under the **Intermediate** settings level. The first set of options we'll tackle live under the **Print** heading.

Layers/Perimeters – This setting page allows you tweak the layer height just as before when in **Simple** mode, but now adds the **Perimeters** setting. This setting is often called “shells” because it controls how thick the “skin” of your printed object is going to be. The default is 2 perimeters.

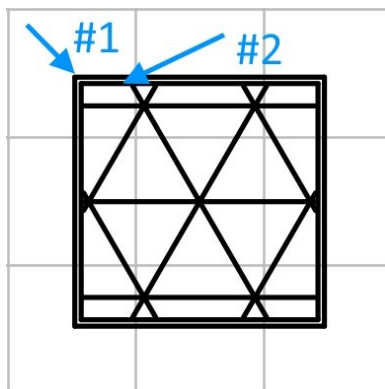

Fig. 22-10: Perimeters in Layer View.

On the left is an example of what two perimeters look like. When the cube is being printed, the #2 perimeter is printed first and then the #1 perimeter. (The order is configurable.)

In Fig. 22-11 you can see what those perimeters actually look like on the cube we printed earlier.



Fig. 22-11: Perimeters as printed.

Infill - The **Intermediate** level adds **Infill Type** in addition to the **Fill Density** figure we covered before. The infill types available are **Triangles**, **Concentric**, **Grid**, and **Lines**. Examples are shown below.

Rostock MAX v2 Assembly Guide

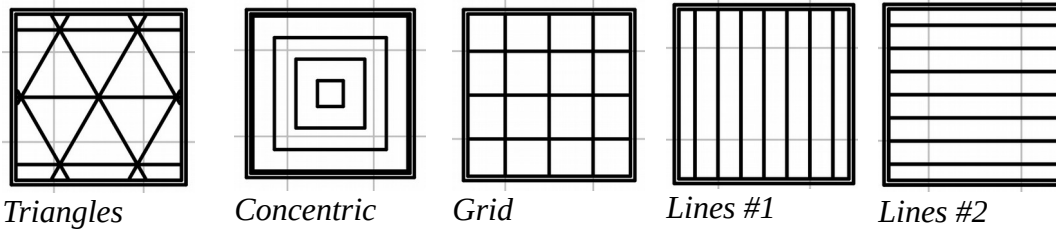

The **Lines** infill pattern differ from the others in that the line orientation is alternated every other layer. All the examples show a 20% infill density.

You're probably wondering which infill pattern is “best”. I wish I could go into that, but I've been unable to locate any studies that cover the topic in any depth. If I were asked to provide a recommendation for a good structural pattern I would probably pick the **Triangles** option. It offers a good internal structure for most infill densities that I've used it with.

Skirt and Brim – This is a new option that appears with the **Intermediate** and **Advanced** setting levels. The **Skirt** option is used one of two ways. First, it can be used to “prime” the hot end with filament before the actual part itself begins to print. You may notice that your hot end may “drool” filament while the bed is heating up and the hot end has already reached temperature. This is perfectly normal. However, without some kind of priming action, early features of your part may not print properly. The **Skirt** solves this. Secondly, the **Skirt** can become a **Brim** if the **Distance from Object** setting is set to zero. What this does is make sure that the skirt is physically connects to the part, becoming a brim. This can be handy when you're printing a small part and you're having bed adhesion issues and you don't want to have to use a raft. Later on in the **Advanced** settings section, you'll see more options on how you can tweak the **Skirt and Brim** settings.

Support Material – With the **Intermediate** and **Advanced** setting levels, you get more control over how the support material for your part is generated.

The new option here is called **Support Type** and allows you to choose a **LINES** or **GRID** pattern for the support material. When I printed the support example, I used the **LINES** mode as that is the default for the **Simple** settings mode. Looking down on it from above, this is what the **LINES** support material pattern looked like for that print.

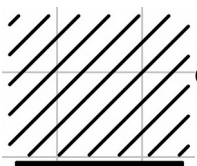

This shows the second layer of the print. The lines will continue to stack upon one another for the entirety of the support structure.

The **GRID** pattern (below) uses the same spacing as the **LINES** option, but is designed to provide more support where it may help to provide a better end result.

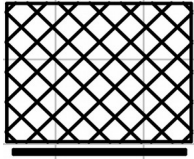

The next new category exposed by the **Intermediate** setting is called **Filament**. Under the **Intermediate** setting, the only option is **Filament**. This allows you to set three parameters that deal directly with the material you're currently using to print with.

Diameter – This is the diameter of the filament you're using. The more accurate this figure is, the better the quality of your prints. This is because the slicer uses the filament diameter to help calculate the optimum flow rate for the extruder during the print.

In order to get an accurate filament diameter, spool off a meter or so of filament and check it in 10 spots along the length of the material. Record the measurements using a digital micrometer and average the results. That average should go into the **Diameter** field.

Extruder Temperature – This figure determines the target temperature of the hot end for the material you're printing with. A typical heat range for ABS is 220 to 240C and 190 to 220C for PLA. Other materials will have their own recommended temperature ranges. **NEVER, EVER, EXCEED 245C WITH THE STOCK HOT END THAT'S SHIPPED WITH THE Rostock MAX!**

The reason for this is because of how the stock hot end is designed. It uses a PEEK section (a high-temperature plastic) as the “cold end” of the hot end. This material will begin to fail at 247C. If you need to print with a high-temperature filament such as Nylon, it's highly recommended that you purchase an all-metal hot end.

Bed Temperature – Like the **Extruder Temperature** the bed temperature is material-dependent. For ABS, a typical heated bed temperature range is between 80 and 100C. For PLA the range is typically 55 to 65C.

Each filament can have different heating requirements, even within the same type and color! For example, it's not unusual to have two rolls of identical material require different hot end settings. Bed temperatures tend to be less variable.

When you're working with a new roll of filament, I recommend printing a test object or two in order to find out what the best temperature setting works best with that material. Note the settings on the spool label, or add your own. This presents a nice opportunity to explain another feature of

Rostock MAX v2 Assembly Guide

MatterControl – material profiles! You'll notice a little pencil icon next to the material drop down



Fig. 22-12: Material Editor.

Click on that to bring up the preset manager.

The **Material Presets** list shows you what pre-configured material settings you've got available to you. When you get a new roll of filament in, you can easily keep track of its settings by using this system. Click on the **Add** button and we'll create your first custom material!

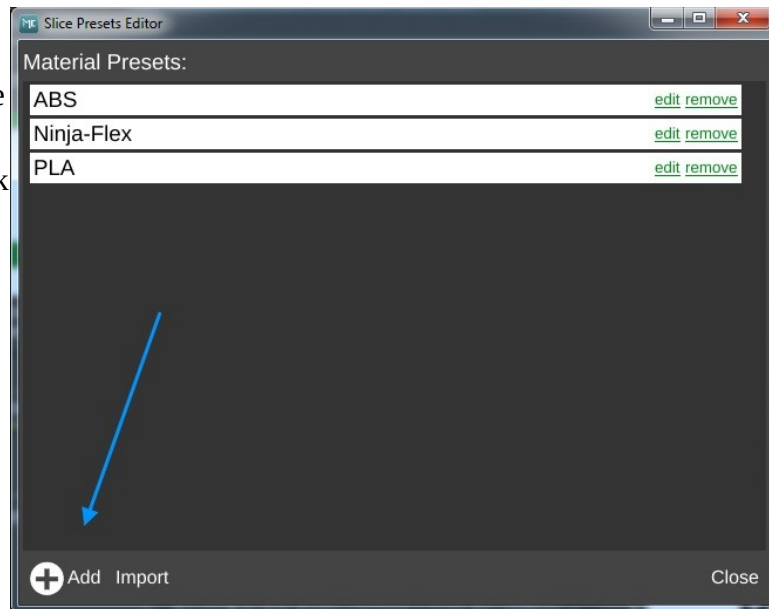

Fig. 22-13: Adding a new material preset.

When you click on the **Add** button, you'll be presented with a screen that looks something like the one shown on the

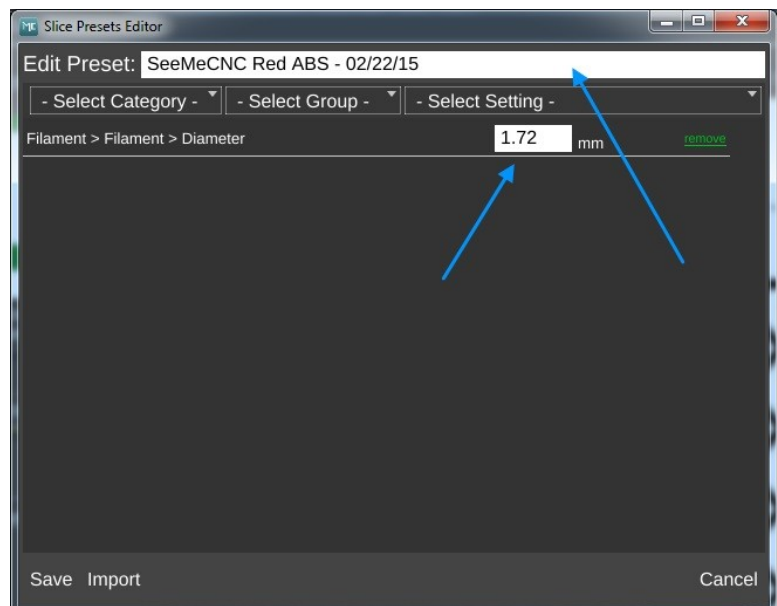

Fig. 22-14: Setting up a new material.

Rostock MAX v2 Assembly Guide

below. The **Edit Preset:** field is where you can name this new material configuration.

In this example, I've named it after the vendor, the material color and the date I purchased the material. Since this is the first time I've used this material, the only thing I know for sure is what the average filament diameter is. To enter that, I picked **Filament** from the **Select Category** drop down, then from the **Select Group** drop down, **Filament** was chosen again and finally **Diameter** was selected from the **Select Setting** drop down.

I then entered the filament diameter that I calculated using the process I outlined to you earlier.

Click on the **Save** button to commit your changes. Congrats, you've added your first custom material profile!

After you've saved your new profile, it will appear as the currently selected material as shown to the right.

Now say you've printed a test cube and have decided that the print might look better if you bumped up the temperature 2 degrees. This is a simple change to make.

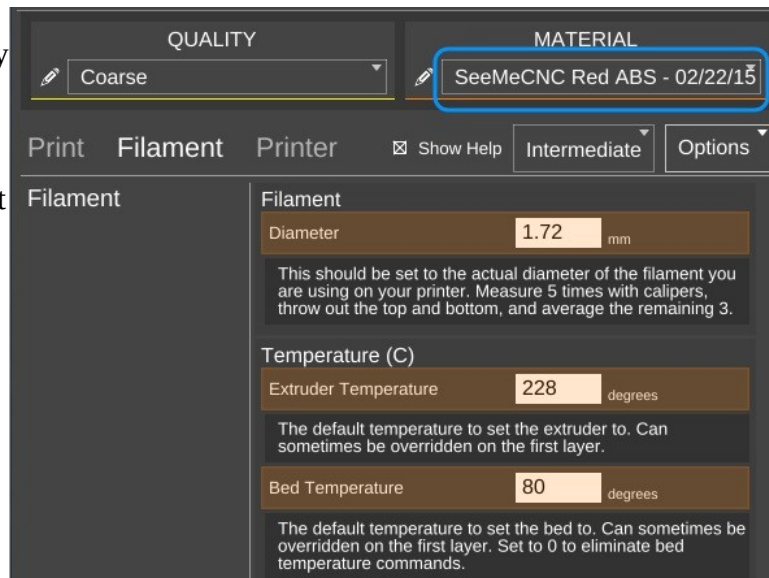

Fig. 22-15: New material added!

If you hover your mouse over the **Extruder Temperature** option, you'll see that the foreground is covered by an **EDIT PRESET** button as shown below.



Fig. 22-16: Overriding a preset value.

Clicking on the button will open up the materials editor and allow you to change the temperature. It's as simple as that!

The last new category exposed by the **Intermediate** mode is called **Printer**. This category deals with the physical properties of the printer itself. Because you chose the specific printer model you have when you first set up MatterControl, all the basic parameters have been filled in for you.

The figures here are pretty self-explanatory. You're unlikely to need to change the parameters on this option page, so let's go to **Extruder** and see what that's all about!

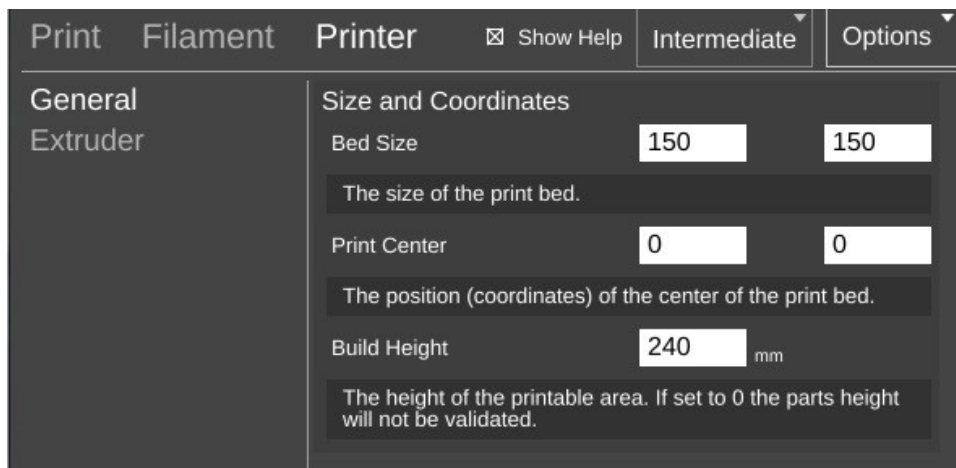

Fig. 22-17: Printer configuration.

One of the nice features of the hot end that the Rostock MAX uses is the ability to change the nozzle that you're using for a print. The stock hot end size is 0.5mm, but if you're going to do really detailed work, you may want to change to a 0.35mm nozzle. If you're doing coarser work and want to print really quickly, you could use a 0.7mm or larger nozzle. In order for the slicer to know how to properly calculate the material flow rate, it needs to know what the diameter of the nozzle is. It goes hand in hand with the material diameter setting that we covered earlier.

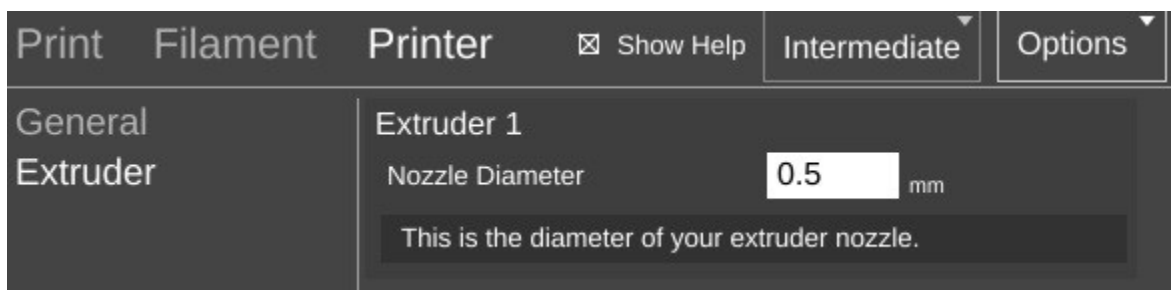

Fig. 22-18: Setting the nozzle diameter.

Before we move on to the next topic, I wanted to cover one more item – the **QUALITY** presets. I'm not going to go in depth on this one except to note that both the **QUALITY** and **MATERIAL**

presets can store identical settings. They're split into two categories in order to make it easier for you to group common settings together. You will typically store things that directly affect the print quality of your model in the **QUALITY** presets. Things like layer height, print speed, etc. **MATERIAL** presets should only contain those settings that directly deal with the material you're using to print the current object with. You'll find that both the **QUALITY** and **MATERIAL** presets contain more options than I've covered here. Those new options are exposed by choosing the **Advanced** settings level. I'll be reviewing those with you later on.

We've covered both the **Simple** and **Intermediate** settings for the slicing engine. **Advanced** is something I'll cover later, so let's move on to the **CONTROLS** section.

The **CONTROLS** page is where you can manually control your Rostock MAX 3D printer. You can heat the hot end or bed, as well as manually position the effector platform and extrude plastic.

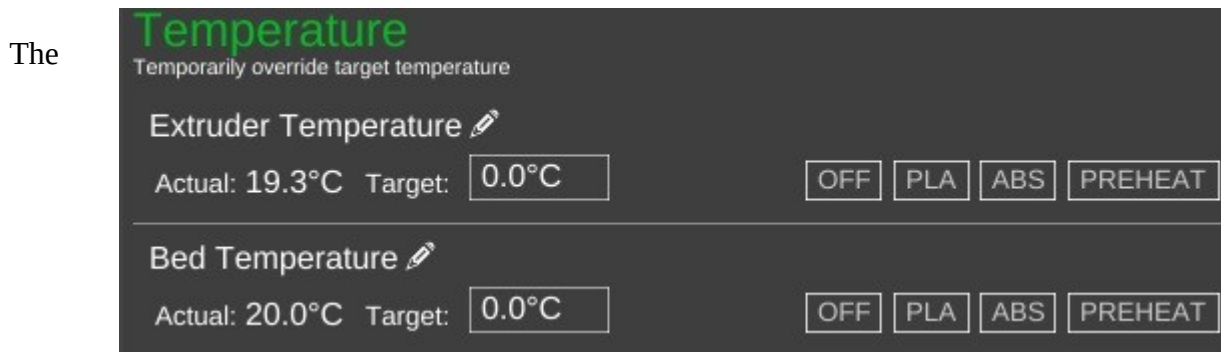

Fig. 22-19: Temperature control pane.

Temperature pane contains everything you need to manually control the temperatures for both the hot end and the heated bed. MatterControl provides PLA and ABS presets. You can edit them by clicking the pencil icons. You can also enter in a temperature and heat to that value by clicking on the **SET** button that will appear as soon as you begin typing.

The **Movement Controls** pane contains controls that will allow you to manually position the Rostock MAX's effector platform.

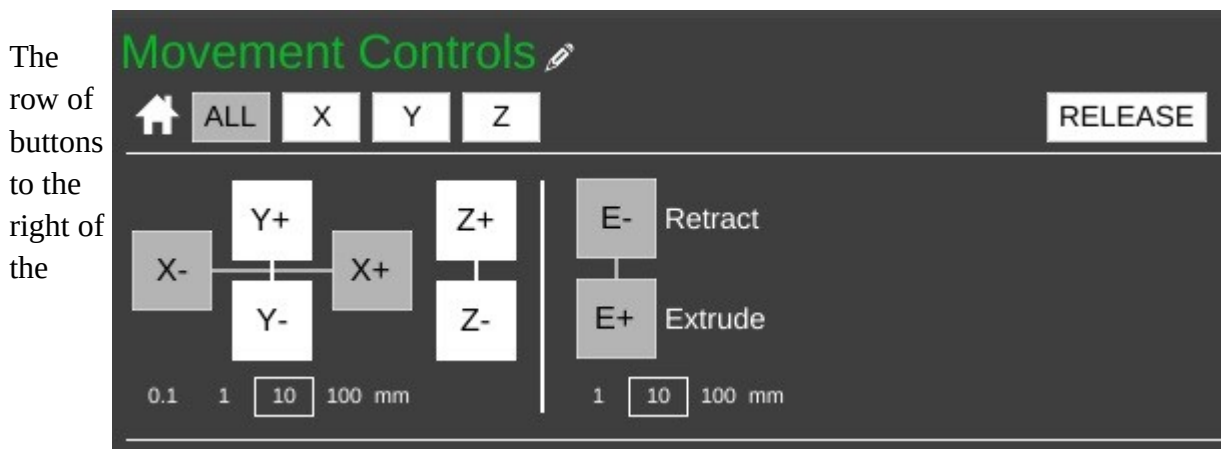

Fig. 22-20: Movement controls pane.

little house icon control “homing” of the movement axes in the Rostock MAX. Because the Rostock MAX is a delta configuration printer, the only buttons active are the **ALL** and **Z** buttons – they perform the same action. Connect your printer if you haven't already and click on one of them to see what I mean. The printer will home itself and await further instructions. (Good robot! Have a Scooby Snack!) The **RELEASE** button will tell the Rostock MAX to power down the stepper motors so that the axes can be moved by hand. This is handy when you want to load new filament into the printer without having to turn it off first.

The axis motion is controlled by the X, Y and Z labeled + and – buttons shown above. Below those four buttons are selectors indicating the step distance from 0.1mm to 100mm. The selected axis will move the selected step distance with each mouse click. For this reason, please take special care when you've got 100mm set for the step distance. The Rostock MAX is smart, but not THAT smart. It relies upon you to not put the poor thing in an unlikely position. :)

The last set of buttons control the extruder motor – they're marked **E-** and **E+** and can be used to manually extrude filament. Note that they will only work if the hot end is up to operating temperature! The amount of filament extruded (or retracted) is set using the step selector below the control buttons for the extruder.



Fig. 22-21: Fan Control.

Advanced settings are covered.

The **Fan Controls** allow you to manually control the layer fan on your Rostock MAX. The fan control will not control the PEEK fan as that is required to be on for the duration of the print job. You can turn the fan on 100% by clicking the control, your you can enter in a percentage value to set it to a speed lower than full-on. I'll go over the use of the layer fan when the

23 – MatterControl Basics: Loading and Printing Objects

We've previously worked with the small cube that MatterControl provided as an example. Now we're going to cover loading and slicing an object from start to finish.

For this section, I recommend you head over to <http://www.repables.com> and find something you'd like to print. I'm going to chose the Orion Key Chain (<http://www.repables.com/r/151/>) for my example print. You don't have to make the same choice, but pick something geometrically “simple” in order to make the learning process a bit easier.

Most (if not all) 3D printer slicing programs can read a file format called “STL”. (You can learn more about this file format, including its origins, here: http://en.wikipedia.org/wiki/STL_file_format) When you download a file from Repables or one of the other free, online object repositories, you'll often get the file as a zip file. One nice feature of MatterControl is the ability to select a zip file and MatterControl will transparently extract all the files it knows how to read and load

Rostock MAX v2 Assembly Guide

them up into your print queue.

To load a file into MatterControl, make sure you're on the **Print Queue** page and click the **Add** button at the bottom right hand corner of the window.

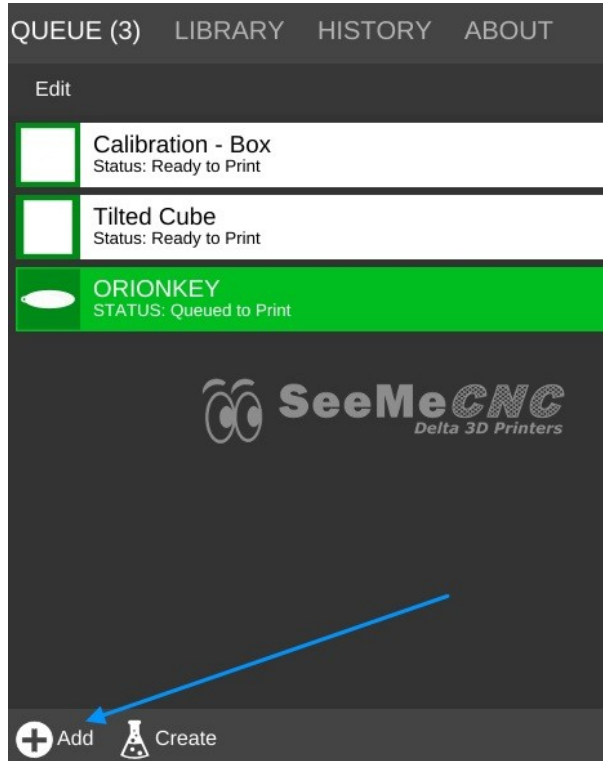

Fig. 23-1: Adding an object to the print queue.

Navigate to where you've stored the STL or ZIP file and open it using the Open File dialog that will appear.

Once you have the object loaded, click on the **Advanced Controls** button so we can make sure your print settings are the way you want them.

For my print, I've decided to leave the **QUALITY** setting at **Coarse** and I'm using the tweaked material values that I set up earlier.

Because the key chain is pretty large, I'm going to scale it down to 75% of it's original size. This is an easy task in MatterControl.

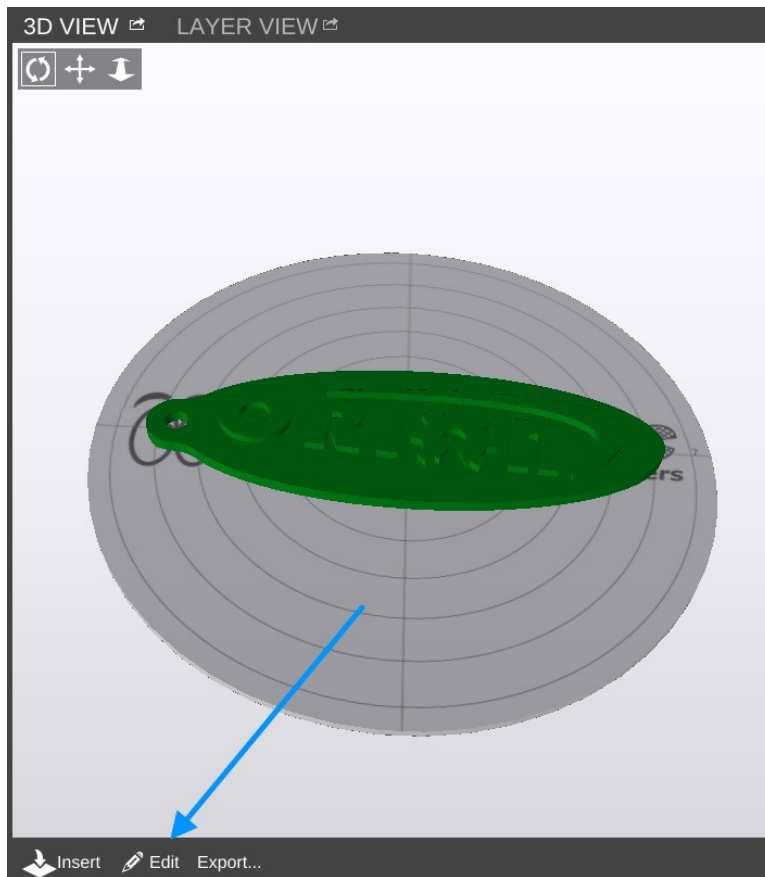

Fig. 23-2: Editing an object.

Click on the **Edit** button as shown above. This will modify the 3D View so the edit controls are visible.

Click on the **Scale** button to access the scaling controls. As you can see, I changed the value to .75 or 75% of its original size. Click on the small up arrow next to the **Save** button at the bottom of the window.

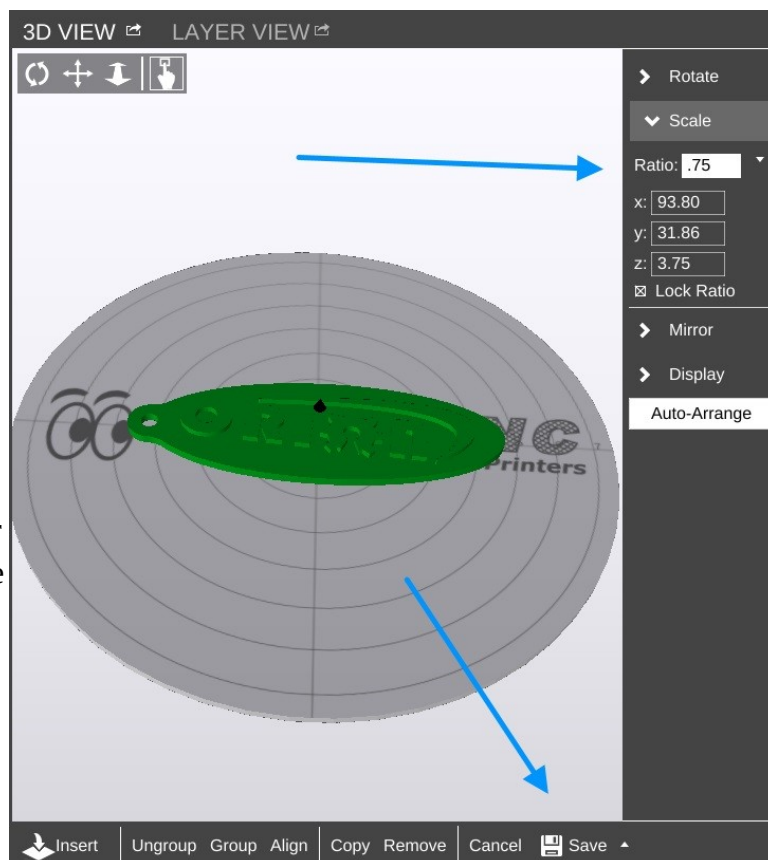

Fig. 23-3: Scaling an object.

Rostock MAX v2 Assembly Guide

This will allow you to save the object under a different name if you don't want to over-write the original.

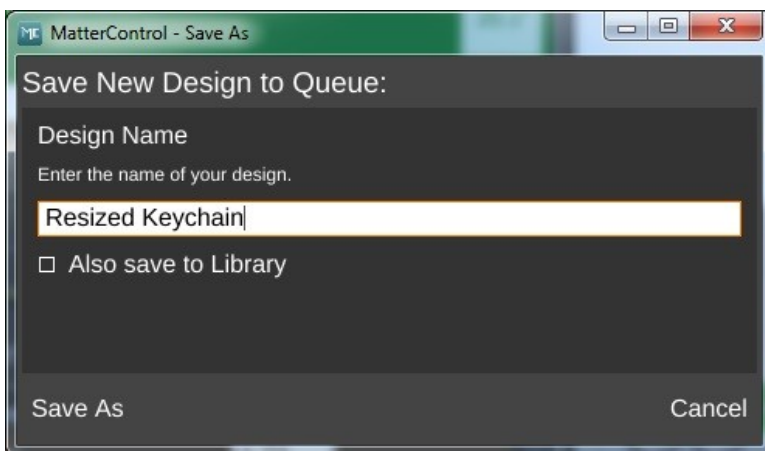

Fig. 23-4: Saving the scaled object.

Before we start this print, let's take a second to examine a feature of MatterControl – the **Layer View**. If you've not sliced this object yet, you'll like see the text “Press 'generate' to view layers”. Go ahead and do that now.

Rostock MAX v2 Assembly Guide

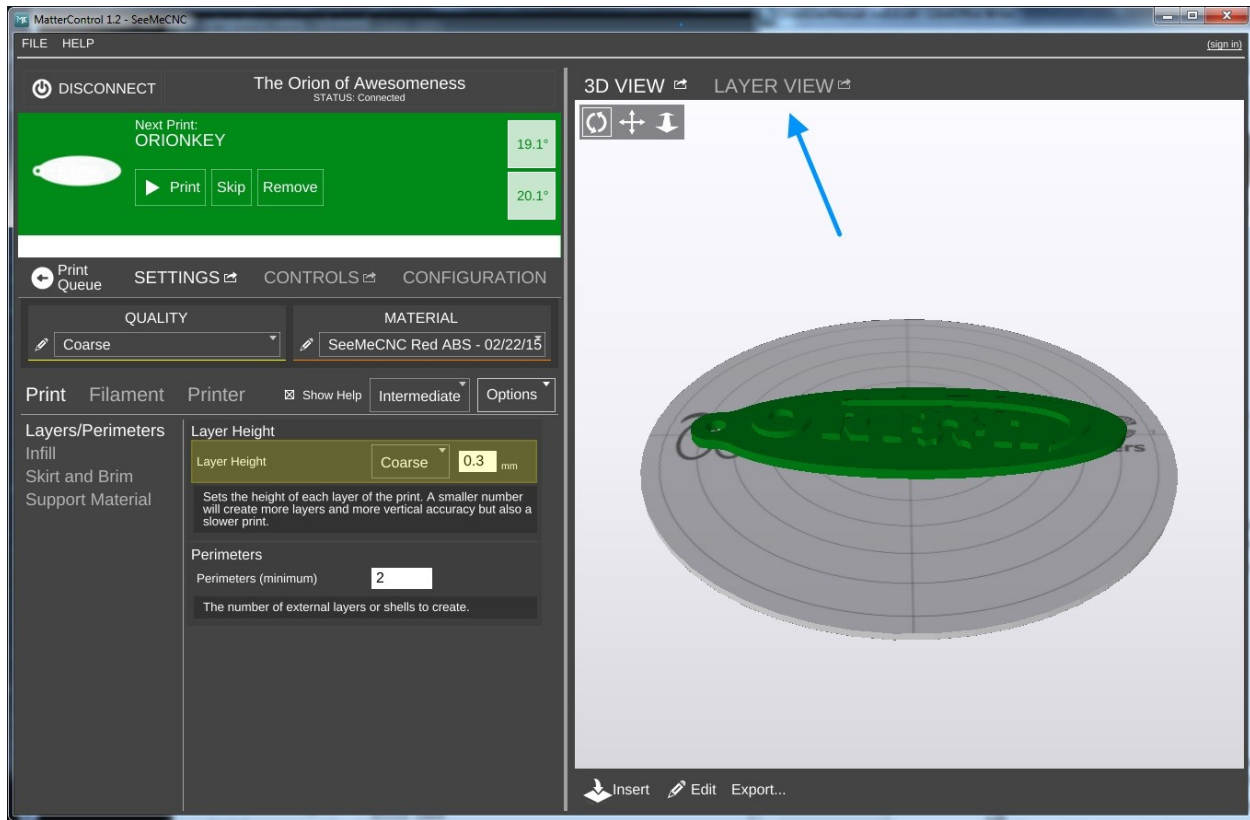

Fig. 23-5: The Layer View.

When it finishes, the layer view will display the first layer of your print job.

You'll notice right off the skirt that I covered previously. It's important to make sure that the hot end is primed by the time it begins to print your part!

At the bottom of the window you'll see some controls that will allow you to either re-slice the object (**Generate**) or view the individual print layers.

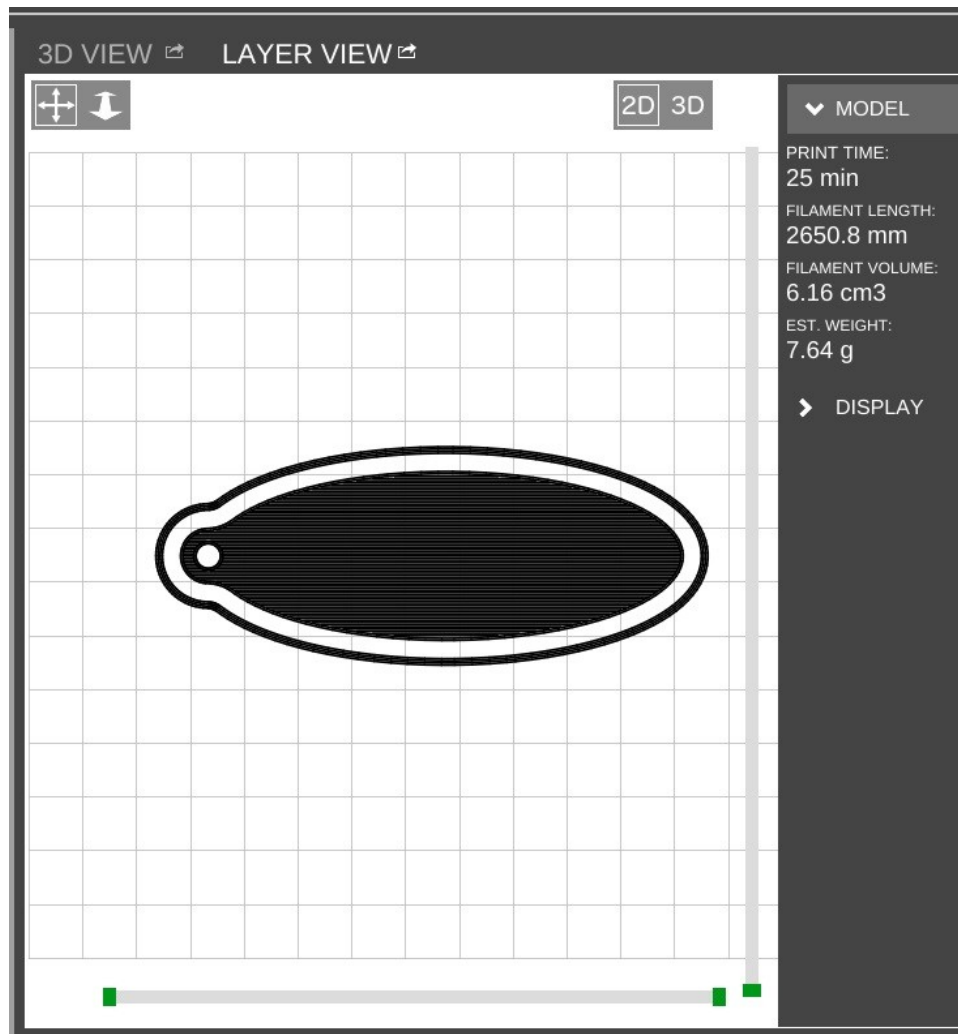

Fig. 23-6: First layer.

The controls will show you how many layers are on this object as well as what the layer number is that you're currently viewing. You can navigate forward and backward through the layers by using the >> and << buttons. If you want to jump to a specific layer, you can enter it in to the box and click **Go**.



Fig. 23-7: Model stats.

After slicing the object, MatterControl will display a few statistics about the current print in the Layer View window. This can be handy information if you're selling your services and need to know how much a particular part is

going to consume in both time and materials.

Go ahead and click the **Print** button and get your object printing!

After the print finishes, you should have a little part that looks something like the photo below (if that's what you printed).



Fig. 23-8: Finished print!

24 – Advanced MatterControl: Configuration

MatterControl includes a number of basic configuration options that you can use to set up things like your default slicing engine, change EEPROM settings, etc.

Let's go over each one as they appear on the MatterControl Configuration pane.

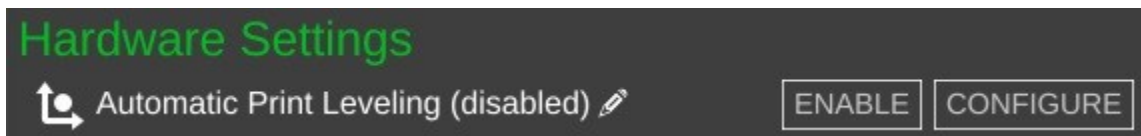

Fig. 24-1: Automatic Print Leveling.

MatterControl includes a bed leveling feature that when properly configured, can assist with issues that can arise from an un-level bed. Note that this will NOT calibrate a delta printer! What it can do is help improve first layer performance on an already calibrated printer.

SeeMeCNC has put together a nice video that illustrates the process quite effectively:

<https://www.youtube.com/watch?v=z6ymbr-AMew>

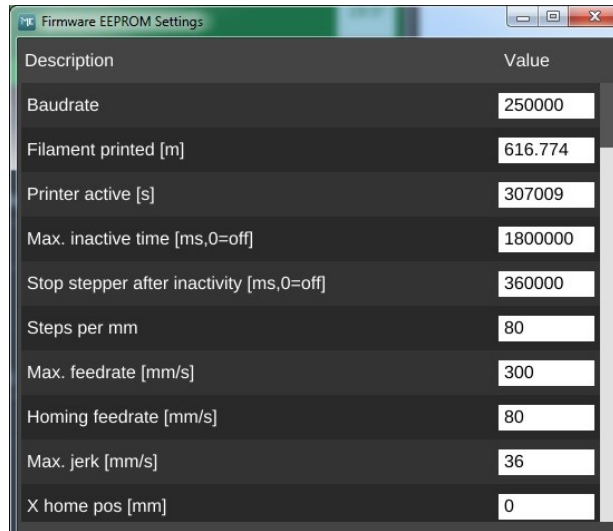

Fig. 24-2: EEPROM Settings.

Rostock MAX v2 Assembly Guide

The EEPROM Settings configuration option will allow you to edit firmware parameters that are stored on the controller inside your Orion. Please take special care when changing EEPROM values. An improperly set configuration parameter can cause your Orion to misbehave. Sometimes rather dramatically. :)

Here's an example of the things you can change under the EEPROM Settings configuration:



Description	Value
Baudrate	250000
Filament printed [m]	616.774
Printer active [s]	307009
Max. inactive time [ms,0=off]	1800000
Stop stepper after inactivity [ms,0=off]	360000
Steps per mm	80
Max. feedrate [mm/s]	300
Homing feedrate [mm/s]	80
Max. jerk [mm/s]	36
X home pos [mm]	0

The Gcode



Fig. 24-4: Accessing the GCode terminal.

Terminal is where you can directly interact with the firmware on your Rostock MAX.

When you first open the Gcode Terminal, you'll be presented with a window that looks similar to the one below:

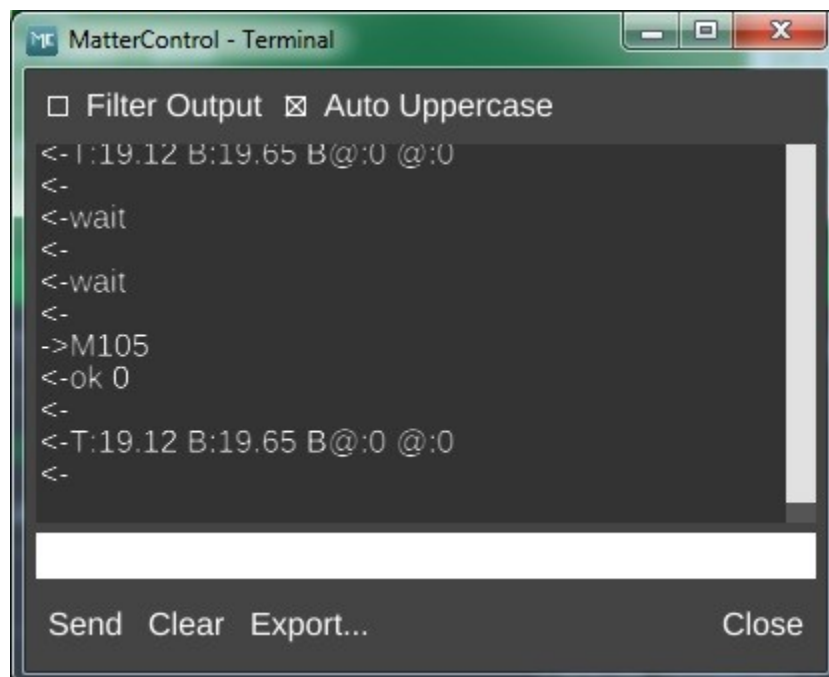

Fig. 24-6: GCode Terminal Window.

You'll notice that the display will scroll as new information comes in from the Orion. This is how MatterControl is able to continually update things like the temperature displays. In order to be able to use the terminal for basic tasks, you'll need to click on the Filter Output check box that's at the upper left corner of the window. This will filter out the telemetry information coming from the Orion's controller and allow you to directly interact with the printer without having the output interleaved with the periodic information that the Rostock MAX transmits.

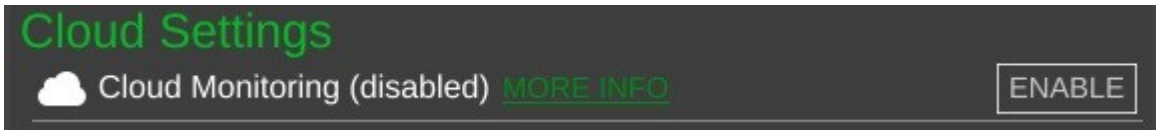

Fig. 24-7: Cloud Settings.

MatterControl provides the ability to remotely monitor your Rostock MAX printer from anywhere in the world. To learn more about this service, click on the **MORE INFO** link in MatterControl.



Fig. 24-8: Notification Settings.

By default, MatterControl will play a bell sound when the current active print job completes. However, you can change this behavior via the **Notification Settings** configuration screen. You'll be able to configure MatterControl to send you an email or text message when your printer completes a job. Note that this feature is only available when you're using MatterControl to run a print job. If you're printing from the SD card, notification won't be possible.

The
Update

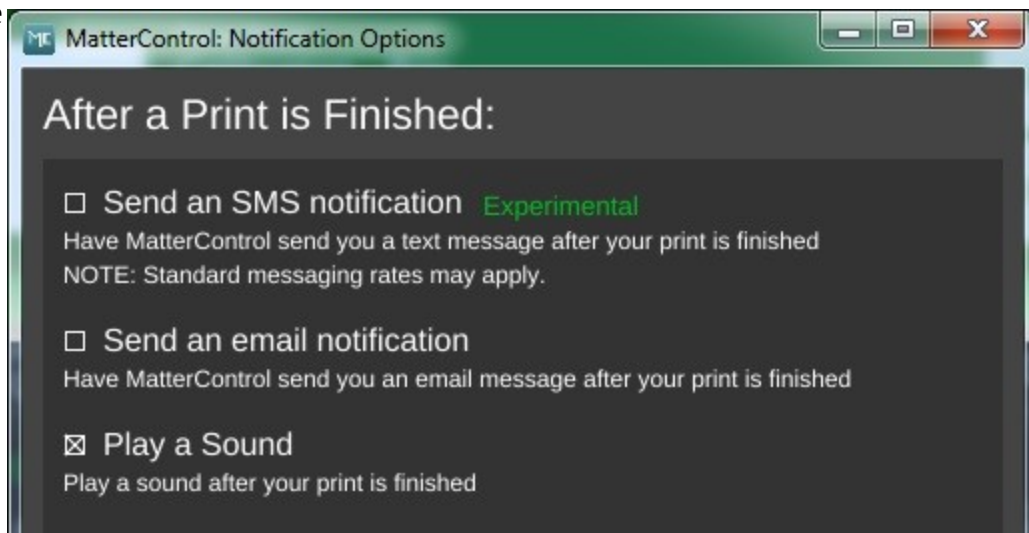

Fig. 24-9: Notification options.



Fig. 24-10: Keeping current.

Notification Feed configuration option allows you to choose which type of release you want to be notified about when there's an update. **Stable** releases are tested and generally recommended for all users. The **Beta** release level represents versions of MatterControl that are in a pre-release state, but testing is ongoing. Use this release level if you enjoy assisting the MatterControl software development team find bugs. Last, there is the **Alpha** release level. This may contain bleeding edge and most certainly lightly tested features. Please only select this level if you're willing to play the part of a guinea pig. :)

This particular configuration option should be pretty self-explanatory. I hope.



Fig. 24-11: Language Selection.

Fig. 24-12: Choosing a slicer.

The **Slice Engine** configuration will allow you to choose which slicer that you want to use in order to prepare your model for printing. By default, MatterControl uses the **MatterSlice** slicing engine that was developed by the MatterControl team. You also have the option of choosing **Slic3r** or **CuraEngine** to do your slicing. Selecting a different slicing engine will change the options available on the **Settings** pane, but shouldn't disturb those you've changed in the past. The MatterControl team has tried to keep common names across slicing engines, so the most noticeable change you'll see will be additional options supported by one slicer but not the others.



Fig. 24-13: Display theme.

Theme/Display Options allows you to change the primary color that the user interface renders in. The top row of color selections provide the selected color against a light background. The second row of color selections provide the selected color against a dark background.

25 – Advanced MatterControl: Settings - Print

MatterControl offers three “classes” of settings that have a direct effect on how your printer works. **Print** covers elements that relate to how the plastic is laid down. **Filament** covers parameters specific to the type of filament that you've chosen to print with. **Printer** handles those remaining parameters that describe the physical printer you're currently using to print with. This section will cover **Print**.

Let's start this overview on the main page of **Print, Layers/Perimeters**.

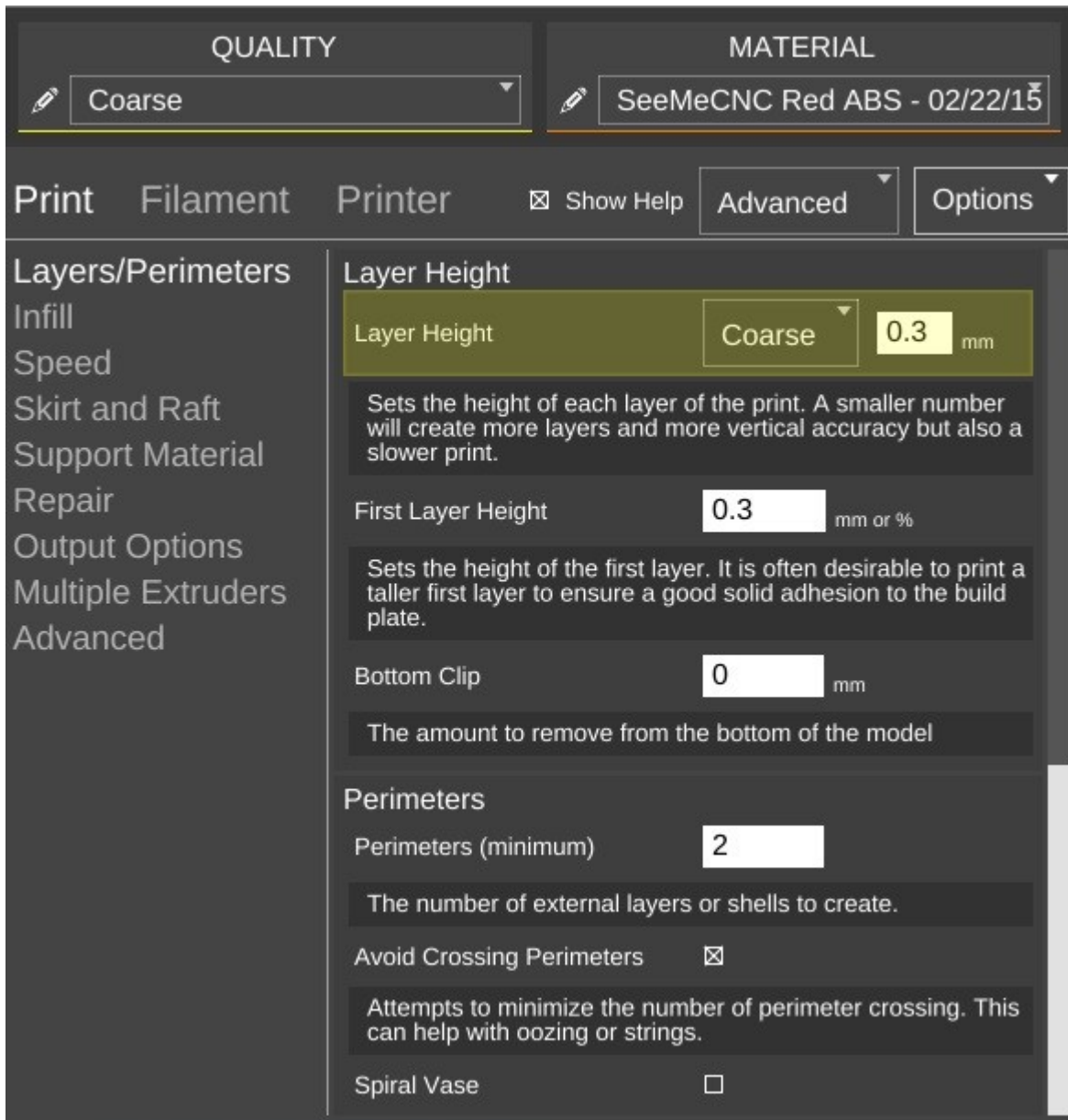

Fig. 25-1: Print layers & perimeters.

The first parameter is **Layer Height**. We've covered this one before, but I wanted to point out something that I didn't go into a lot of detail about earlier. You'll notice that the field has a yellowish highlight to it. That means that the value exists in the currently selected **QUALITY** profile. If you look carefully, you'll see that the highlight color matches the thin colored line under the **QUALITY** drop down. (This same effect holds true for **MATERIAL** profiles, but the color is orange.)

Any time you add a **Print** parameter to a preset profile, it will be highlighted just as the **Layer Height** field is in the example. Note that you can use any of the **Print**, **Filament**, or **Printer** configuration parameters within either of the **QUALITY** or **MATERIAL** profile editors.

Rostock MAX v2 Assembly Guide

First Layer Height	<input type="text" value="0.3"/>	mm or %
--------------------	----------------------------------	---------

The **First Layer Height** parameter allows you to set the thickness of your first layer. Having a thicker first layer will help provide a good base to build the rest of the part on as the thicker (and thus wider extrusion) will help improve the adhesion to the bed. If your first layer isn't any good, the part could eventually separate from the bed and ruin the print job.

Bottom Clip	<input type="text" value="0"/>	mm
-------------	--------------------------------	----

Bottom Clip allows you to tell the slicing engine that you'd like to “clip off” a specific amount from the bottom of the model. For example, say you've got a 200mm tall model, but you only want to print the top 50mm or so. You can enter 150 into the **Bottom Clip** field and when the slicer generates the G-code for the print job, it will begin slicing 150mm up from the bottom of the model.

Perimeters	
Perimeters (minimum)	<input type="text" value="2"/>

Perimeters dictate how thick the “skin” of your model is. 2 or 3 perimeters are good for most parts, but if you want a really strong exterior wall, you can make the perimeter count as high as you feel you need it. To get an idea of how thick the skin will be, you multiply the perimeter count by the extrusion thickness (we'll get to that parameter in a bit). For example, if you have a 0.5mm nozzle, chances are your extrusion thickness will be set to 0.5. 2 perimeters will give you a skin thickness of 1mm.

Avoid Crossing Perimeters	<input checked="" type="checkbox"/>
---------------------------	-------------------------------------

When **Avoid Crossing Perimeters** is enabled, the nozzle path will not cross a part perimeter during travel moves. This will help reduce the opportunity for stringing or oozing since the nozzle tip is rarely over open air. For instance, if the tool path would normally cause the nozzle to travel from one side of the part to the other, it would cross at least two perimeters and may leave strings of material in its wake as it moves. If it is set to not cross perimeters, it will cause the nozzle to trace a perimeter back to the nearest point where it can begin printing again instead of jumping straight across to the new extrusion position.



Spiral Vase mode allows you to print things like vases or other open top, single-wall objects in one continuous layer. What happens is that instead of the slicer raising the nozzle up a full layer height for each new layer, it gradually increases the Z height as the print progresses. This results in a perfectly seamless object, which can be important for artistic prints such as vases. When you're printing a vase or similar object, you'll want to make sure that you set the top layer count to zero to prevent the vase getting a "lid" that you'll have to cut off.



By default, objects are printed from the inside features to the outside. If you want to reverse this process, enable **External Perimeters First**. This will cause the outside of the model to be printed before the interior features.



The **Top** and **Bottom** solid layer parameters dictate how thick the top and bottom surfaces of your object are when printed. These two parameters fulfill essentially the same function as the **Perimeters** parameter, but for the top and bottom of the part. You can calculate your top & bottom thickness by multiplying the solid layer count by the layer height. For example, 5 top layers will result in a final top thickness of 1mm if your layer height is 0.2mm.

The next page in **Print** is called **Infill** and covers how the interior of your part is filled. While I covered **Fill Density** and **Infill Type** earlier, the **Advanced** mode adds two new parameters.



The **Starting Angle** parameter allows you to control the orientation of the infill. For example, an infill type of **GRID** with a starting angle of zero degrees is going to look like this:

Now if you change the starting angle to 45 degrees, you'll end up with an infill pattern that looks like the example below.

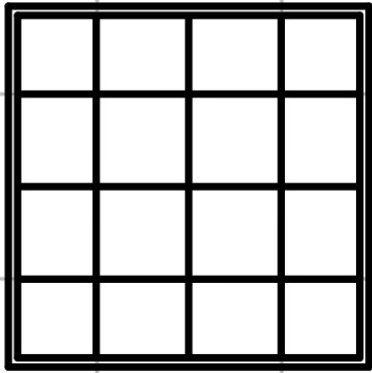

Fig. 25-2: Grid infill.

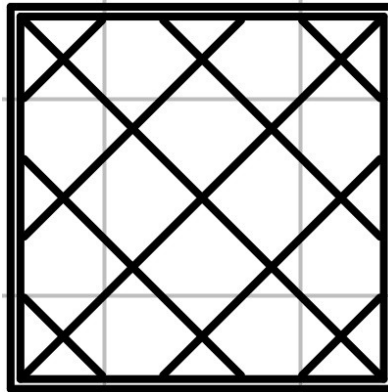

Fig. 25-3: Grid @ 45 degrees.

Note that changing the starting angle will also change the angle in which the top and bottom layers are printed. You can see this in the image below – this shows the second layer as it would be printed.

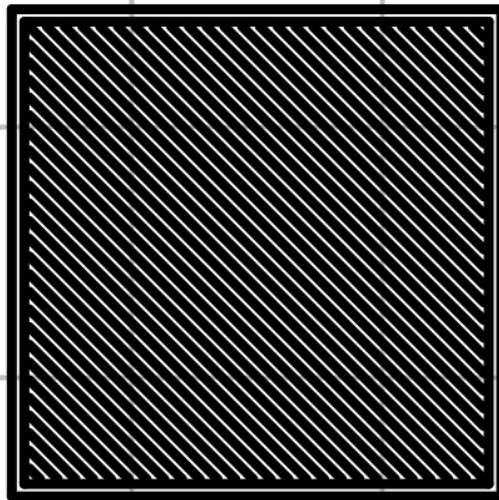

Fig. 25-4: Top & bottom layer pattern.



Infill Overlap is used to adjust how well the infill pattern attaches to the inside perimeter of the part. A good infill will have a solid connection to the inside perimeter of your part, and the structural integrity of your part depends on this.

Rostock MAX v2 Assembly Guide

The **Speed** page covers parameters that control how fast various features of the object are printed. The speeds are listed in mm per second, or as a percentage of a related speed parameter.

The speed parameters are pretty self-explanatory, especially if you've got the **Show Help** check box set. However, there's a couple of points I'd like to cover about printing speed.

First of all, there is a relation between your print speed and the temperature you've set for the material you're printing with. The basic rule is, the faster you go, the hotter you print. This is because as the hot end extrudes plastic, it's constantly being cooled by the cold filament that's coming in.

Setting the extrusion temperature higher allows the hot end to melt the incoming plastic at a faster rate. This allows you to print more quickly. The relation between print speed and extrusion temperature is one of those things you'll get a feel for as you gain experience with your printer.

You'll quickly learn that the Orion will “talk” to you if you're printing too rapidly for a given temperature. The extruder will begin to “skip” periodically (or frequently, depending on how fast you're going). A skipping extruder has a very distinct sound – it's kind of a light bump or knocking. If you watch the nylon gear that you use to manually feed filament, you'll notice that it will briefly rotate in the opposite direction at the same time you hear the skipping sound. If you draw a line on the face of the gear, you can spot this motion more easily. The skip is caused by the hot end's inability to melt the material as rapidly as is required. The pressure builds up until the stepper motor can no longer generate the force required. At this point the tension in the filament is released like a spring and the filament pushes back with enough force to cause the stepper motor to skip steps, resulting in a short reverse rotation.

Secondly, there is also a direct relation between print speed and print quality. In the image above, you'll notice that the speeds for print moves vary a bit. This is because some features don't require a focus on surface quality.

Perimeters are a great example of this. You'll note that the inside perimeter speed is 40mm/sec, while the outside perimeter is 35mm/sec. The inside perimeter will never be seen after the print is finished so it can be printed at a higher rate. However, you want the visible surface of the print to be smoother and more consistent, so you print the outside perimeters a bit more slowly.

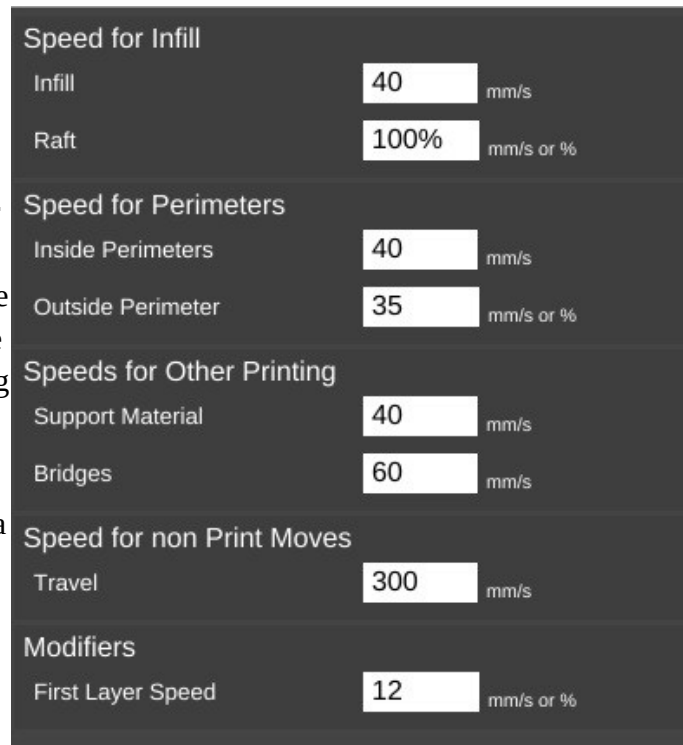

Rostock MAX v2 Assembly Guide

The last bit about speed settings I want to cover is the first layer speed. You'll see that it's *really* slow. The reason for this is that while hot plastic loves to stick to hot plastic, hot plastic doesn't like sticking to other things as much. By going slowly on the first layer, you're giving the material time to get a good grip on the surface of the bed. This is known as “part adhesion”. When a part comes unstuck from the bed during a print, it's ruined. This isn't so bad when you're five minutes into a print, but you'll be ready to flip a table when it happens 18 hours into a 19 hour print.

The **Skirt and Raft** page covers settings that control how the hot end is primed at the beginning of a print job as well as features that help the part stick to the bed.

The first section covers the **Skirt** feature. A skirt in this context is basically a series of single-layer loops printed around the perimeter of the part. This acts as a method to “prime” the hot end with material before the actual part begins to print. **Loops** defines how many times you want to go around the print. This is tied to the **Minimum Extrusion Length** parameter. If the number of loops you specify are not enough to meet that minimum length, additional loops will be added automatically.

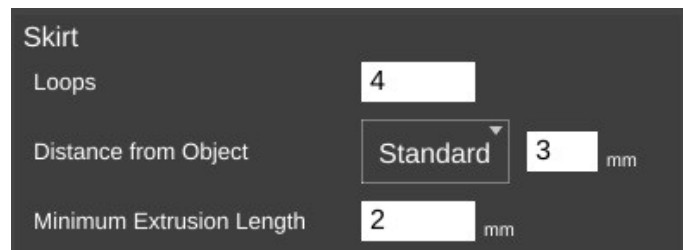

The **Distance from Object** parameter dictates how far away the loop stands off from the part outline. If you set the distance to zero, the skirt will become a “brim”. It will result in the loops being printed connected to the first layer of your print. This can give small parts a first layer that has a larger surface area to improve part adhesion. Since the brim is only a single layer thick, it's usually pretty easy to remove after the print job has completed.

I mentioned earlier that hot plastic really loves sticking to hot plastic, but not so much to other things. If a brim isn't doing the job for you, you can try a **Raft**.

When in **Intermediate** mode, the **Raft** setting was grouped with **Support Material** and was simply an on/off thing. In **Advanced** mode, you've got a lot more control over how the raft is laid down.

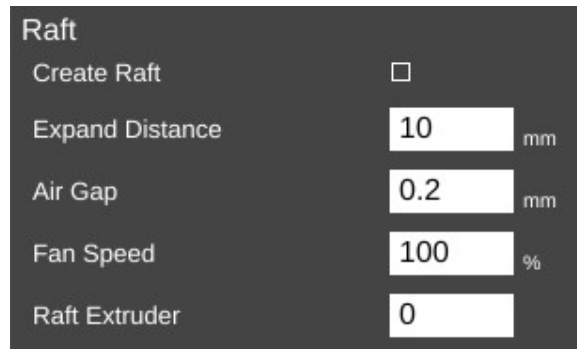

Expand Distance is the distance you'd like the raft to exceed the base area of the part you're printing. You may want to adjust this parameter if the part you're printing is larger than the bottom contact point on the bed. A larger raft will help to support the part more effectively.

Air Gap defines how much space you want between the top surface of the raft and the bottom surface of your part. This gap helps make it easier (or even possible!) to remove the raft from your part

when it's finished. As mentioned in the help text, a good air gap is one half the diameter of the nozzle. For example, if your nozzle is 0.5mm, you'd want an air gap of 0.25mm.

You can use the **Fan Speed** setting to cool the raft as it's being printed. This is typically only used when printing with PLA.

If you've added a second extruder to your Orion, you can specify which one should be used for rafts by setting the **Raft Extruder** value to the index of the extruder you want to use. If you don't have multiple extruders, you can leave this set to zero.

The **Support Material** page provides detailed settings on the use of support material if the part you're printing requires it. While I covered the basics of support earlier, I'm going to get a bit more in-depth on it here.

Checking **Generate Support Material** will allow you to configure support for your part. Support is required when a part has an overhang or other angled feature that would result in little or no physical support to put a print layer on. The **Support Type** selection allows you to define the geometric pattern for the support structure. You have **GRID** and **LINES**. These patterns were covered earlier, so I won't cover them again here. The new parameter you have to work with in **Advanced** mode is called **Amount**.

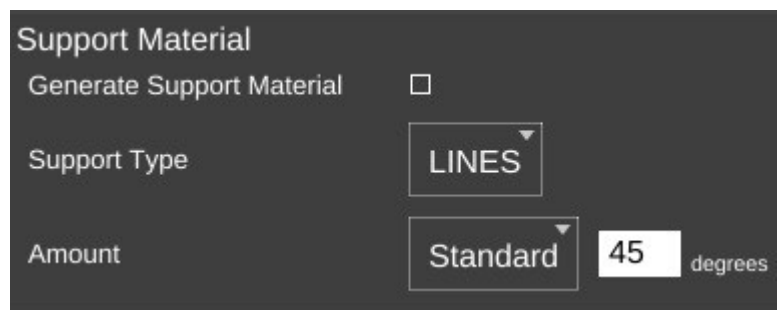

Amount is expressed in degrees from vertical and tells the slicing engine to generate support for any feature that meets or exceeds the specified angle. In the setting shown above, the slicing engine will generate support at points where the model “overhangs” 45 degrees or more from vertical.

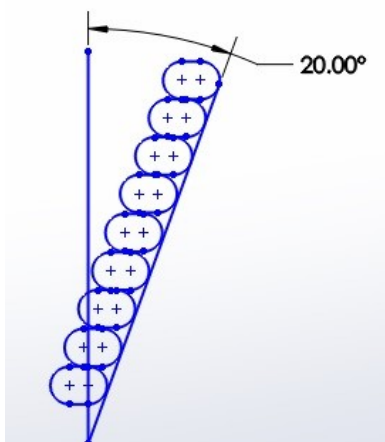

When you've got a part feature that's only 20 degrees or so, each layer can easily be supported by the layer underneath. This is because as the part height increases, the horizontal dimension increase is less than

Fig. 25-5: 20 deg. overhang.

the extrusion width. This means that each new layer has a solid foundation to adhere to as it's being applied.

As you can see when your angle increases to 45 degrees, each layer has much less surface area to adhere to as you print. This is where support comes in handy. It provides that underlying structure for those layers to build upon.

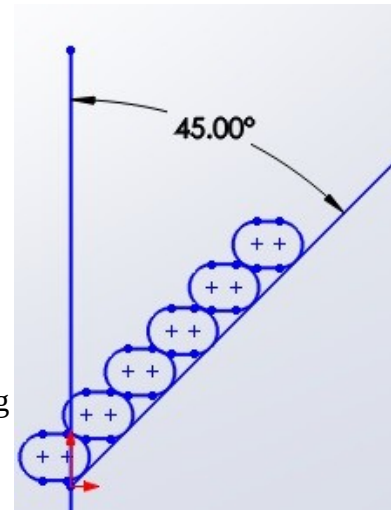

Fig. 25-6: 45 deg. overhang.

As the angle increases, the underlying surface area for each layer becomes smaller and smaller until there's simply not enough surface for the next layer to adhere to. In these instances, support material is practically a requirement if you want your part to print at all.

Now that you've got a good handle on why support can be useful, let's go over the parameters that you can tune to get good support that is easily removable from your part.

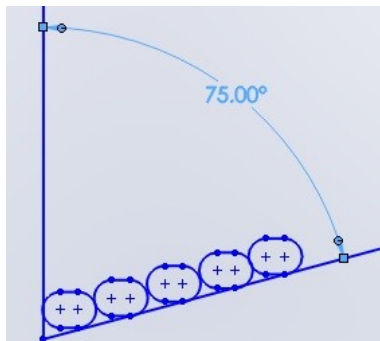
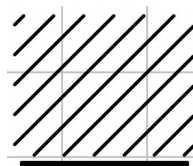

Fig. 25-7: 75 deg. overhang.

Pattern Spacing controls the distance between each “track” of support that is laid down to support your part. The wider the spacing, the less support that is printed.

Infill Angle adjusts the angle at which the support structure is built.



45 Deg. Infill

Support Options		
Pattern Spacing	2.5	mm
Infill Angle	45	degrees
Interface Layers	0	layers
X and Y Distance	0.7	mm
Z Gap	1	layers
Support Everywhere	<input type="checkbox"/>	

Interface Layers allows you to specify solid layers interspersed with the support material. This comes in handy when using multiple extruders. For example, if you're printing a part in PLA with lots of support, you can generate all the support with PLA, and then have 5 or 6 interface layers of PVA (a water soluble filament). The print would then only be in contact with the PVA interface layers and it would be a flat layer to print on. When finished you can dissolve away the interface layers and the rest of the support falls off the part cleanly.

X and Y Distance dictates how far away the support structure will be from the part you're printing. You want it as close as you can get it without it actually touching the surface of the part. The default of 0.7mm seems to work out pretty well.

Z Gap specifies how many layers should separate the support material from the part. This parameter contributes to how easy or difficult it is to remove support material from the part once the print is finished. If you have too little gap, the support material will have more of a grip on the part surface making it difficult to remove. If the gap is too large, the support material won't be able to do its job very effectively.

If **Support Everywhere** is checked, you're probably going to get more support material than you bargained for. If you have an internal feature of a part, this may be required in order to support it, but keep in mind that it will also add support to features like horizontally oriented holes, which don't normally need support to print properly.

If you've got multiple extruders on your Orion, these parameters allow you to specify which extruder is used for generating support structure.

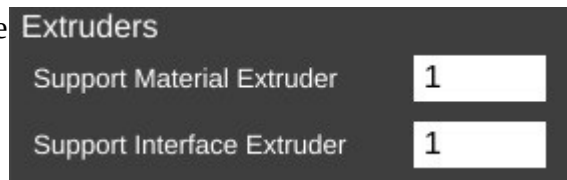

The **Repair** page contains a couple of settings the govern how (and if) the slicer will attempt any repair of invalid part models.

Sometimes modeling programs will create a model that isn't "water tight", meaning it's got gaps in the surface. These gaps make it difficult for the slicing engine to do its job and in

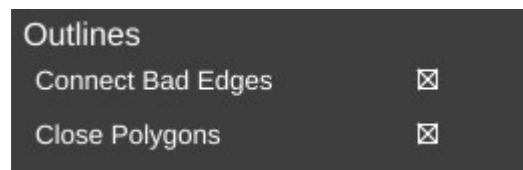

Rostock MAX v2 Assembly Guide

some cases can cause the slicing operation to fail. The **Repair** option is MatterSlice's attempt to help fix these issues if they're detected.

On the **Output Options** page is a single parameter, **Center On Bed**. This will automatically center the model on the print bed when you load it. If you don't want that to happen, just uncheck the box.

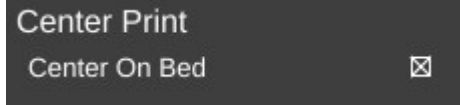

The **Multiple Extruders** page has two settings that control how ooze & filament wipes are handled.



The **Wipe Shield Distance** specifies how far away from the part you want what is commonly known as an “ooze shield” to be placed around the part. In a two extruder system, the unselected hot end will create this “shield” in order to avoid dripping or oozing plastic on other parts of the model.

Wipe Tower is used when changing extruders. The active nozzle creates a tower of the specified size and will use it to wipe the nozzle in order to reduce the possibility of oozing or dripping material on the model while the other extruder is active.



The last page on the **Print** tab is called **Advanced**.

The **Advance** page currently only has the **Extrusion Width** section.



The **First Layer** parameter allows you to specify the extrusion width of the first layer. A first layer width that's larger can help with how the material adheres to the bed. You can specify it as either an actual width, or as a percentage of the normal extrusion with (typically the same as the nozzle diameter).

Support Material allows you to specify how wide you want the extrusion to be for the support structure if you're using it.

26 – Advanced MatterControl: Settings - Filament

The **Filament** tab allows you to change parameters that deal with the current filament you're printing with. The **Filament** page is divided into three categories; **Filament**, **Temperature**, and **Retraction**.

Rostock MAX v2 Assembly Guide

The filament **Diameter** parameter tells the slicing engine the size of the material you're printing with. When starting a new roll of material, you should pull off about 2 meters of material and check it in 10 spots along the length using a digital caliper. Average those samples and plug the result into the **Diameter** field. This is a good way of getting a good estimate of the material you're actually using. This allows the slicing engine to deliver more consistent results instead of depending on the generic size of the material.

Filament	
Diameter	1.72 mm
Extrusion Multiplier	1

You'll notice that the **Diameter** field is highlighted in orange. This means that the parameter is part of a predefined material configuration. When using a new spool of material for the first time, it's a good idea to create a new profile for it when you're taking the sample measurements of the diameter. A good rule of thumb is to include the date you started using the filament as part of the material profile name. Note the date on the spool label if it has one and add one if it doesn't. This will help you track individual spools of the same color and manufacturer.

The **Extrusion Multiplier** parameter allows you to tweak the flow rate of the material coming out of the hot end. A basic rule of thumb on this is to restrict the max value to 1.1 and the minimum value to 0.9. Note that these aren't hard limits but are simply a guideline to utilize until you're familiar with the effects this parameter has on print jobs.

The **Extruder Temperature** is the temperature for the hot end, **Bed Temperature** is the temperature for the heated bed. As you can see, both of these are part of the currently selected material profile. Each material class has a general temperature range for the hot end. For example, ABS extrusion temperatures can range from 195 to 240C. PLA likes anywhere from 180 to 215. The specific temperature that your material works best at varies by manufacturer and chemical blend. It's not unusual to see different "sweet spot" temperatures among identical colors of material, even with the same manufacturer.

Temperature (C)	
Extruder Temperature	228 degrees
Bed Temperature	80 degrees

The **Bed Temperature** parameter typically has a lot less of a range than the extrusion temperature does. A good rule of thumb here is 55-60C for PLA and 80-100C for ABS.

Retraction covers how the slicer "retracts" the filament during travel operations where it's not actually laying down plastic. Good retraction settings help keep your part free of little strings and blobs during printing.

Retraction	
Length on Move	5 mm
Length on Tool Change	10 mm
Speed	110 mm/s
Z Lift	0.3 mm
Minimum Travel Requiring Retraction	20 mm
Minimum Extrusion Requiring Retraction	1.5 mm

Rostock MAX v2 Assembly Guide

Length on Move specifies how much filament will be backed out of the hot end during a non-printing move.

Length on Tool Change is specific to multi-extruder systems. If the slicer is changing to a new extruder, it will retract the material out of the current hot end by this much. This works in conjunction with wipe towers and wipe shields.

Speed dictates how fast the extruder drive will pull the filament out of the hot end. Higher speeds can assist in preventing already-melted plastic from oozing or leaving strings on the part being printed. It also controls how fast the filament will be returned to the hot end when the non-printing move has completed.

Z-Lift is used to lift the nozzle off of the part as each retract finishes. This can help prevent blobbing.

Minimum Travel Requiring Retraction is used to prevent retractions during very short moves when retraction isn't really necessary. When executing a non-printing move, the nozzle will have to travel at least this distance in order to trigger a retraction action.

Finally, **Minimum Extrusion Requiring Retraction** specifies how much filament must be extruded before a retraction operation is permitted. This helps prevent instances where a retraction operation would occur before the hot end had the opportunity to actually extrude material.

The **Cooling** page covers parameters relating to layer cooling.

Enable Extruder Lift if set, will cause the hot end to lift up from the part to allow cooling.

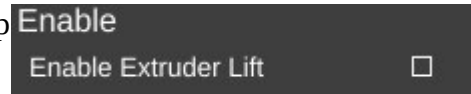

The **Fan Speed** section controls how and when the cooling layer fan is used.

Minimum and **Maximum Fan Speed** controls the lower and upper limits of how fast you want the fan to go when it's enabled. If you specify a minimum speed, the slicing engine will automatically vary the speed of the fan between the min & max values,

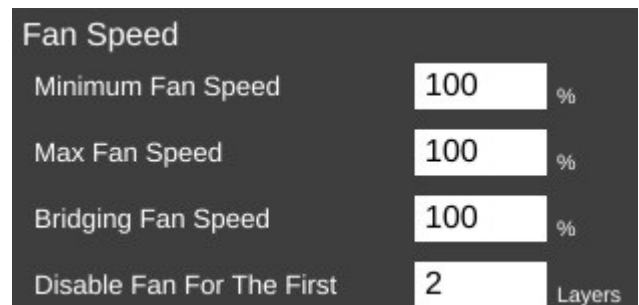

Rostock MAX v2 Assembly Guide

depending on the location being printed. For larger parts, the slicing engine may run the fan more slowly than it would for smaller parts.

Bridging Fan Speed covers the speed that the fan should run at when the slicer is creating a filament bridge. A bridge is basically a free-hanging length of filament with no support below it. Some materials like PLA form excellent bridges if cooled while being extruded.

Disable Fan For The First n Layers allows you to make sure that the fan isn't activated during the crucial first few layers of a print. You typically don't use the fan for at least the first two layers in order to help ensure good bed adhesion.

Cooling Thresholds allow you to slow the print speed down during a print if needed. If the current layer will require more than the specified time to print, the slicing engine will automatically slow the print speed down to meet this goal. This can

be important because if you don't use a fan, a layer will need time to radiate its excess heat before the next layer is applied. If the material isn't cooled, or given time to cool via radiation, heat can build up in the underlying layers and cause curling and other undesirable effects.

Minimum Print Speed can be used to ensure that the printer doesn't slow down TOO much, which can cause its own heating problems. For example, if you're printing too slowly, the presence of the nozzle moving over the surface can cause heating to areas adjacent to the nozzle tip which can cause blobbing or layer deformation.

Note that none of the fan options will come into effect unless you've enabled the operation of the fan. I'll cover that in the next section.

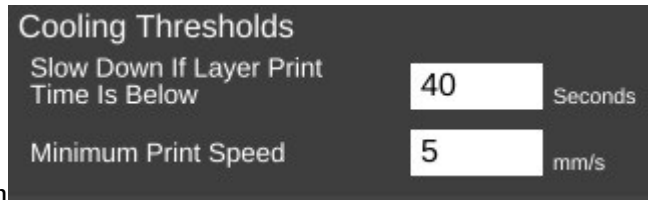

27 – Advanced MatterControl: Settings - Printer

The **Printer** section covers items that are specific to the printer being used for the current print job.

The **General** page covers parameters that describe the mechanical features of the printer.

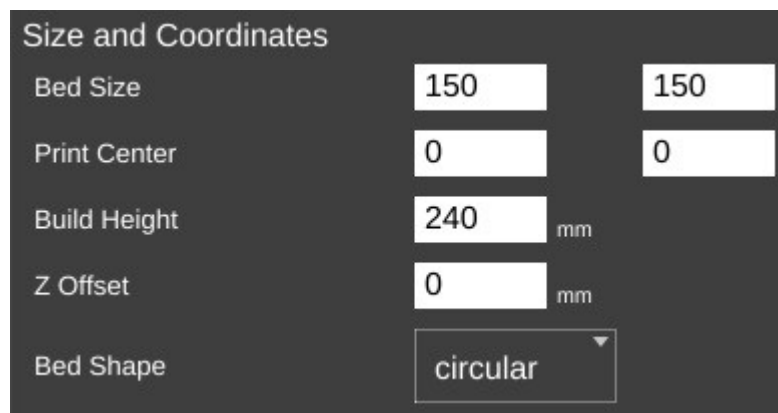

Rostock MAX v2 Assembly Guide

The **Bed Size** fields cover the width and length of the bed. Since the Orion has a round bed, you'll see that both figures are the same, the **Print Center** has been set to 0,0 (the center of the circle) and the **Bed Shape** has been set to **circular**.

The **Build Height** parameter should be set to the highest practical build height. In the case of the Orion, this is set to 240mm.

Z Offset can be used if you want to set a specific adjustment to the z position of the G-code when it's created by the slicing engine.

The **Bed Shape** parameter dictates what bed type is shown in the 3D viewer.

The **Hardware** section allows you to specify what features are installed on your Orion.

Has Fan, when checked will allow the slicing engine to control the layer cooling fan.

Has Hardware Leveling should be set if you've added a mechanical depth probe for leveling the bed on your Orion.

Has Heated Bed should be checked for the Orion. This allows the slicing engine to control the heat of the bed.

Has SD Card Reader should be checked for the Orion. This allows MatterControl to save STL and G-Code directly to the SD card if it's installed in the Orion.

For a stock Orion, **Extruder Count** should be set to 1. If you add an additional extruder in the future, you can tell the slicing engine about it here.

Share Temperature is used when utilizing multiple extruders that share the same heat source.

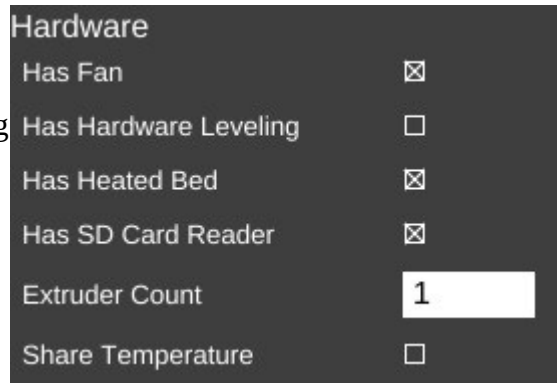

The screenshot shows the 'Hardware' settings panel with the following options:

Option	Value
Has Fan	<input checked="" type="checkbox"/>
Has Hardware Leveling	<input type="checkbox"/>
Has Heated Bed	<input checked="" type="checkbox"/>
Has SD Card Reader	<input checked="" type="checkbox"/>
Extruder Count	1
Share Temperature	<input type="checkbox"/>

The **Firmware** section allows you to tell the slicing engine about the firmware you're using with your Orion.

Z Can Be Negative can be checked if the firmware you're using on your Orion will accept Z positions below zero. Leave this unchecked if you're using the stock Orion firmware.

G-Code Output specifies what “flavor” of G-Code should be created by the slicing engine. For the Orion, this should be set to **REPRAP**.



The screenshot shows the 'Firmware' settings panel with the following options:

Option	Value
Z Can Be Negative	<input type="checkbox"/>
G-Code Output	REPRAP

The next page is called **Custom G-Code** and allows you to customize the code sent for five different print events. Unless you're familiar with what the listed G and M codes do, please don't modify the defaults shown.

Start G-Code is inserted into the G-Code output right after the temperature setting. If you have the commands to set the temperatures in this section, they won't be generated outside of this section. You can also include values from other sections such as "first_layer_temperature"

End G-Code is inserted into the output at the very end, after all print operations have been completed.

Pause G-Code is sent when the Orion is paused during a print.

Resume G-Code is sent when the Orion is resumed.

Cancel G-Code is sent when you cancel a print job from MatterControl

The screenshot shows a dark-themed interface with five sections for G-code configuration:

- Start G-Code:** M104 S{temperature}, M190 S{bed_temperature}, M109 S{temperature}, G28
- End G-Code:** M104 S0 ; turn off temperature, M140 S0, G91, G1 Z10 E-5.0 F12000
- Pause G-Code:** G91, G1 Z10 E-10 F12000, G90
- Resume G-Code:** G91, G1 Z-10 E10.8 F12000, G90
- Cancel G-Code:** M104 S0, M140 S0, G28, M4

The last page for the **Printer** tab is called **Extruder**. This page allows you to configure each extruder you have installed in your Orion.

Nozzle Diameter specifies the diameter of the currently installed nozzle in the hot end.

Extruder Offset allows you to specify the offset from the center of the effector platform in the Orion. This parameter is only used in multi-extruder configurations.

The screenshot shows the configuration for Extruder 1 with two input fields:

- Nozzle Diameter:** 0.5 mm
- Extruder Offset:** 0

The last feature I'd like to cover can be found here:

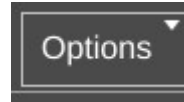

The **Options** control allows you to import and export configurations. This can be handy when you want to share your slicing engine settings with others, or import settings from other sources.

28 – Using the 3D and Layer Views

Using the 3D View and Layer View

The 3D View will show you the part that will be printed when you hit the **Print** button. The Layer View is used to inspect how your part will be printed, one layer at a time.

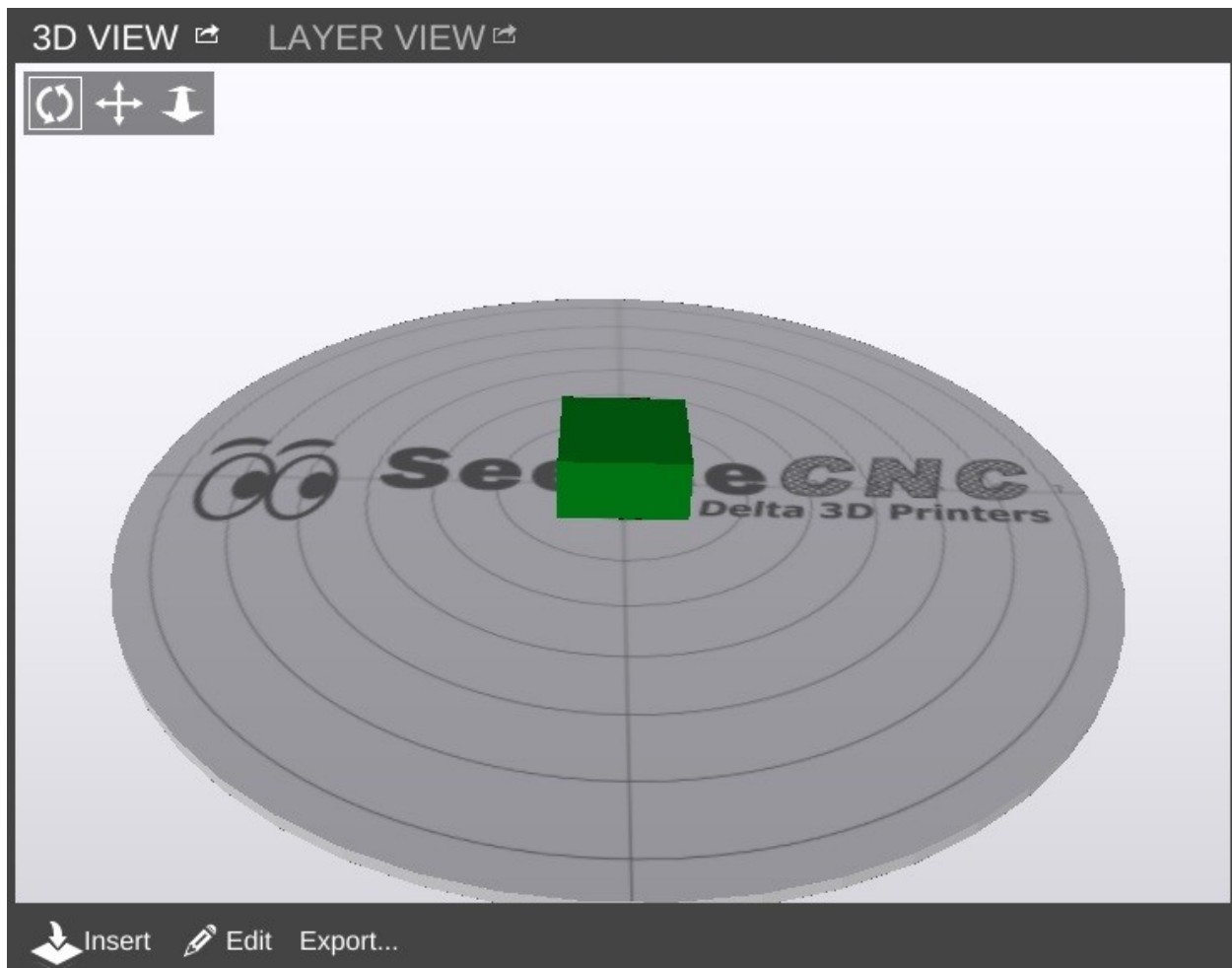





Fig. 28-1: The 3D View.

The 3D View will allow you to view your model in pretty much any orientation you'd like. The view orientation is controlled one of two ways. You can select one of the movement icons

 in conjunction with the left mouse button. The first icon will allow you to “free rotate” the model and build platform. The second icon will allow you to move the part and build platform left and right, as well as up and down. The third icon will allow you to zoom in and out.

You can use the mouse alone as well. Holding down the left mouse button will allow you to “free rotate” the model and bed. Holding down the mouse wheel will allow you to move left and right as well as up and down. Spinning the mouse wheel will zoom in and out.

The 3D View will also allow you to directly manipulate the part or parts currently being displayed on the virtual print bed. The first control, **Insert**  Insert  Edit  Export...

bed. To give you an idea of how this works in practice, head over to Repables and grab the “Ignite Michiana” object – <http://repables.com/r/146/>.

MatterControl is pretty smart – you don't have to extract the STL file from the ZIP file. Click on **Insert** and navigate to where you saved the downloaded zip file and select it. When the file is loaded, your screen should look something like this:

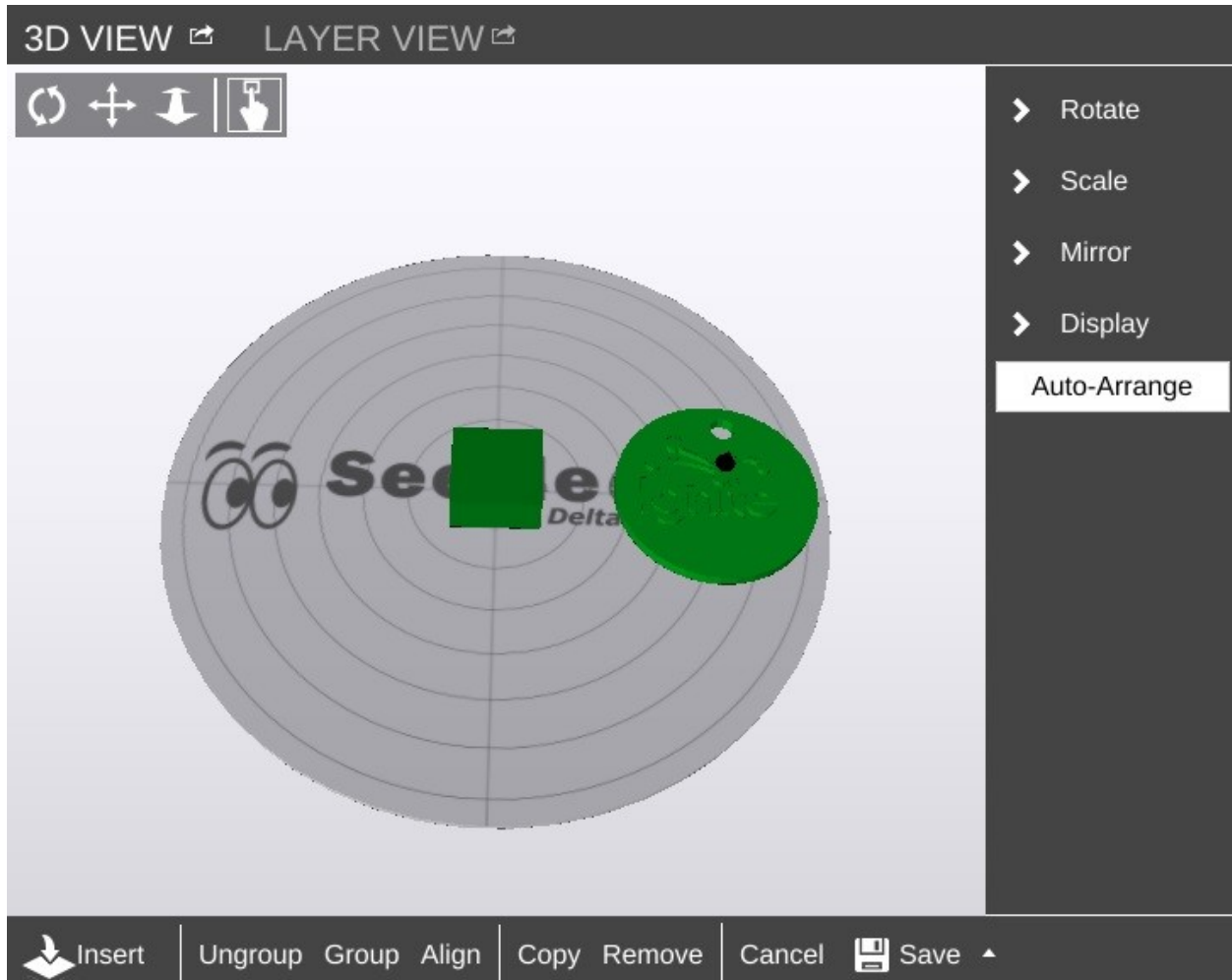

If you didn't already have the example cube loaded, you may only see one object in the center of the bed. If this is the case, go ahead and load another Ignite object. If you can't see the object you've just loaded, click the **Auto-Arrange** button to automatically move the objects to the virtual bed.

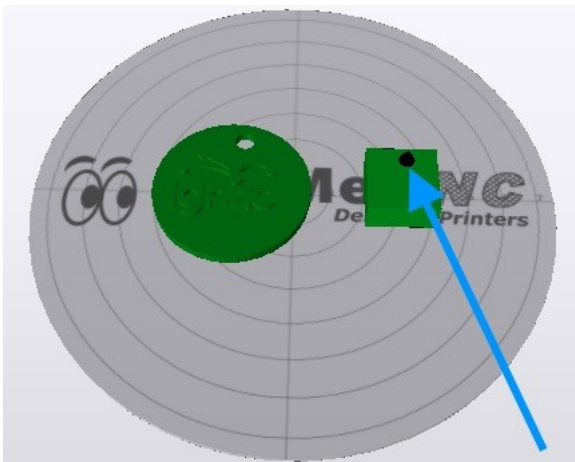

Fig. 28-2: Object selected.

You'll end up with something similar to the figure below after clicking on **Auto-Arrange**.

The blue arrow points to a tiny icon that indicates which is the currently selected object.

Rostock MAX v2 Assembly Guide

In order to move an object around manually, you'll need to make sure that the “picker” icon has been selected.



Once you've clicked on that icon, you'll be able to move the parts any where you like. However, be aware that the software will allow you to move the objects outside the confines of the virtual bed and they will not be printable outside of those limits.

You'll notice that you've got some new controls along the bottom of the 3D View window – **Ungroup, Group, Align, Copy, Remove, Cancel, and Save.**

The **Ungroup** button will undo the “grouping” done by the **Group** and **Align** buttons.

Clicking **Group** will virtually connect all the objects on the print bed so they can be moved all at the same time.

The **Align** button has the same effect as the **Auto-Arrange** button, but the resulting group of objects are not centered on the virtual print bed.

Copy allows you to create duplicates of objects that are on the print bed as shown below. Make sure that you've got the object you want to copy selected before you click the **Copy** button.

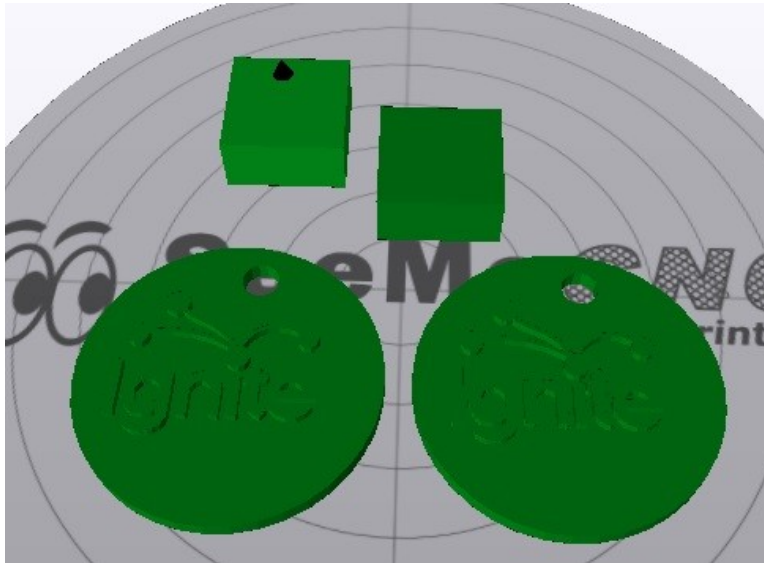

Be aware that if you've got your objects grouped, clicking on **Copy** will result in the entire group being copied.

The **Remove** button works as you'd expect. Select an object and click **Remove** to remove it from the virtual build surface.

Cancel will discard any changes you've made so far and **Save** will allow you to save the state of the virtual print surface. Saving your work saves it to the print queue. If you'd like to save your work as a combined STL file

While you're in edit mode, there's a series of commands that become available along the right edge of the 3D View pane.

Unlike normal manual positioning, the **Rotate** function allows you to specify the exact rotation of the object along its X, Y, and Z axes.

In order to change the orientation of the object, simply enter the value you want in the **Degrees** field and then click the axis you want to apply that value to. Below is an example of what the example cube looks like after rotating it 45 degrees along its X axis.

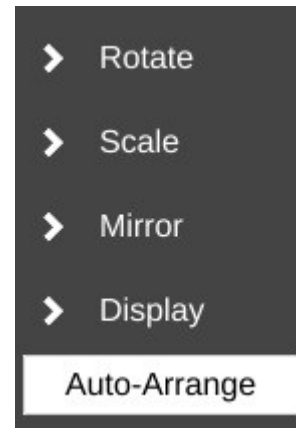
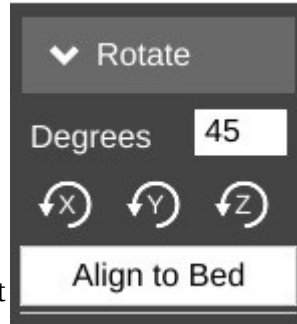

Being able to re-orient the part on the build surface can be handy to have, especially if you're dealing with a part that was saved in a position that didn't lend itself to easy 3D printing.

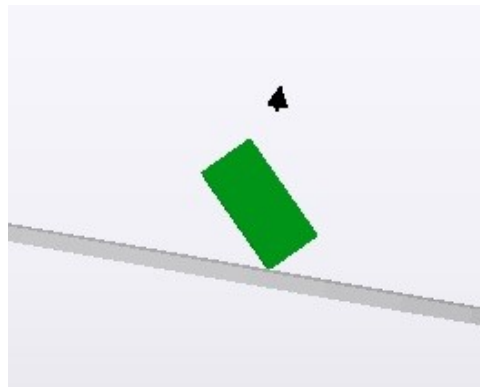
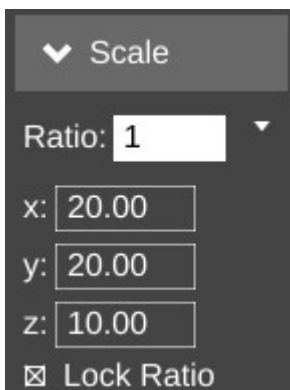

Fig. 28-3: Tilted object.

Clicking **Align to Bed** will automatically orient the nearest flat surface to the virtual build platform.

The **Scale** function will allow you to change the width, height and length of the part or parts currently on the virtual build platform.



Rostock MAX v2 Assembly Guide

The **Ratio** field allows you to shrink or grow an entire model by a specific percentage. For example, if you were to change the **Ratio** from 1 to 1.5, you'd see this:

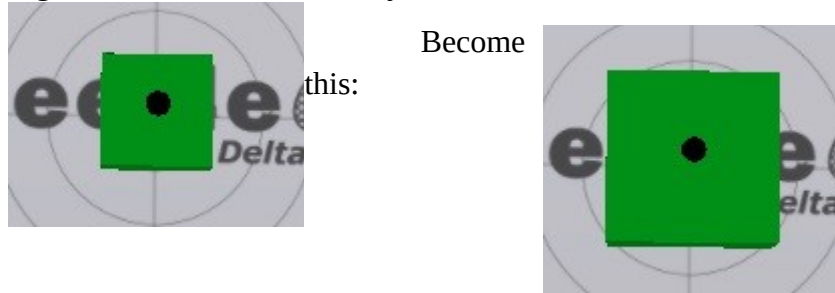

The scaling operation made the cube 150% larger than the original. The **X**, **Y**, and **Z** fields allow you to specify exact dimensions. However, as long as the **Lock Ratio** field is checked, any change made to those fields will adjust the others to maintain the same ratio.

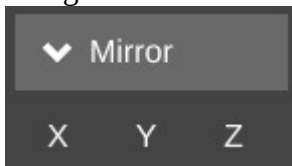

The **Mirror** function will simply allow you to “mirror” the object along any of the three axes. Note that mirroring the **Z** axis will flip the part upside down, so be careful.

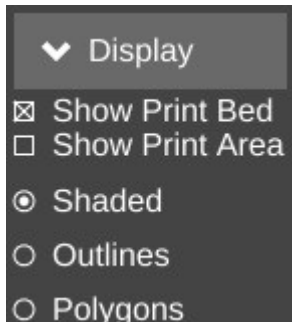

The **Display** function allows you to modify how the 3D View pane operates. **Show Print Bed** is pretty obvious. Uncheck it and see what happens! **Show Print Area** is handy when you want to see exactly how much space your parts are going to take up. When selected, it will display a shadowed cylinder that encapsulates the maximum bed diameter and print height, as show below.

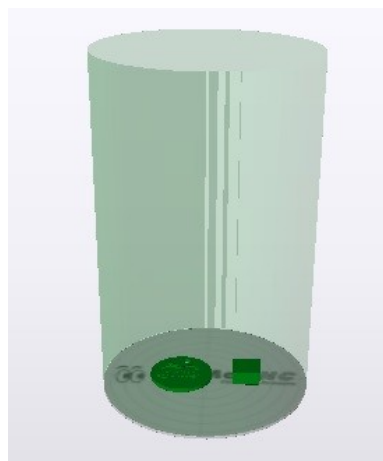

The **Shaded**, **Outlines**, and **Polygons** options allow you to change how your objects are drawn. By default the **Shaded** option is checked. For most parts this is fine, but if you'd like to see detail that the solid shading can hide, click **Outlines**. Models used for 3D printing are built out of a few up to many thousands of polygons. If you'd like to see what the polygons look like that make up your model, click the **Polygons** option.

I find that the **Outlines** display option is the most useful as it makes part details really stand out.

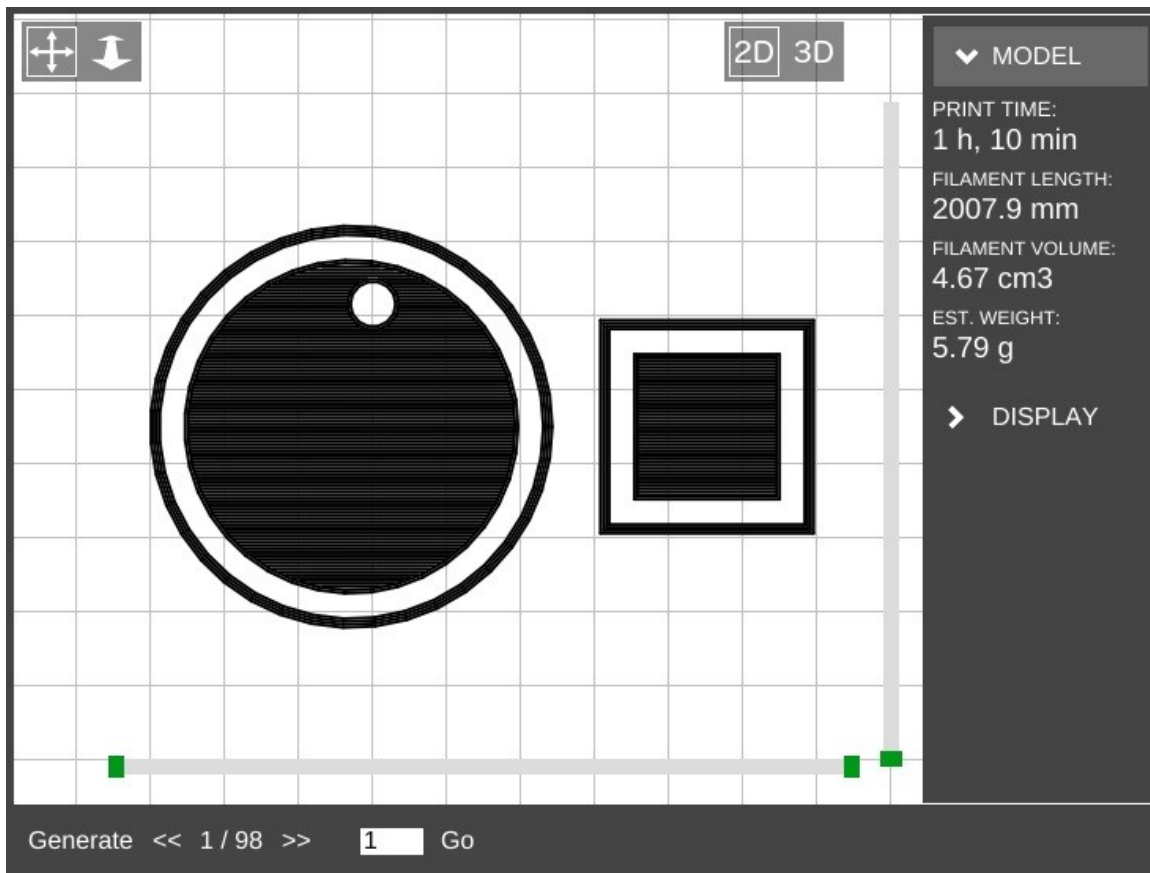

Fig. 28-4: The Layer view.

'generate' to view layers". Click the **Generate** button in the lower left corner of the Layer View display. This will hand over the parts to the slicing engine and will create the G-Code required to print your parts. In the image above, you can see that the parts have been sliced and layer #1 is being displayed.

The **Layer View** is where you can see exactly what the Orion is going to do while printing your part. When you first select it, it may show "Press

Rostock MAX v2 Assembly Guide

Along the right side of the display, you'll see a printing time estimate as well as an estimate of how much filament will be required to print the two parts shown.

There are two “scroll” bars shown in the Layer View. The bar along the bottom will show progress of the current layer, while the vertical bar will show layers. Using the << and >> buttons along the bottom, you can step through the layers one at a time, or jump to a specific layer and click on the **Go** button.

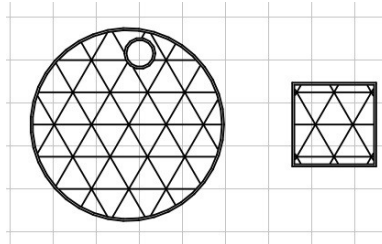

Fig. 28-5: 7 Layers in.

The Layer View will also allow you to see the layers in 3D. Just click the **3D** icon at the upper right corner of the display window to see your layers in 3D! The display can be moved around in the same manner as that shown for the 3D View.

The Layer View will also display other

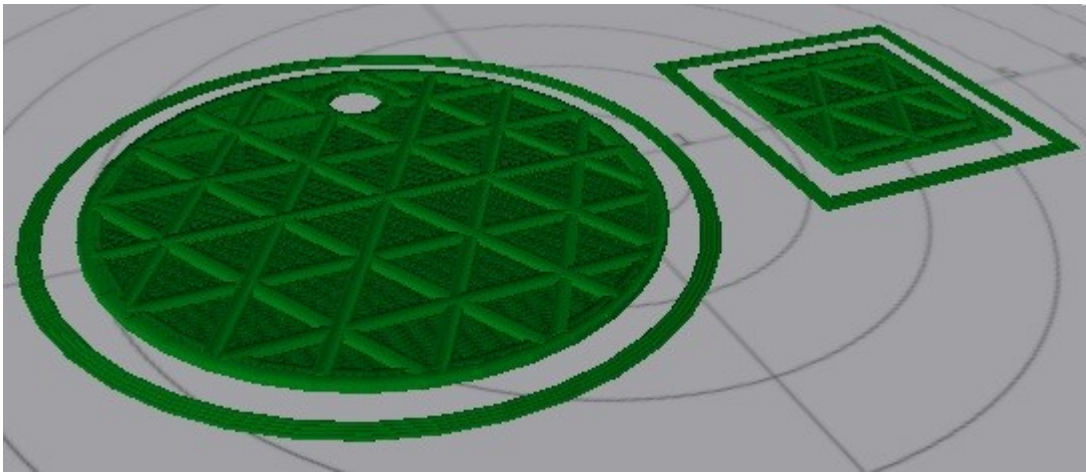

Fig. 28-6: 7 Layers in, 3D view.

information about the printing process, such as non-printing movement, retractions, etc. Click on the **Display** button to the right of the display to open up those display options.

Grid hides or displays the virtual print surface.

Moves will show you the path the print head takes when it's *not* printing, as shown by the light green lines in the image below.

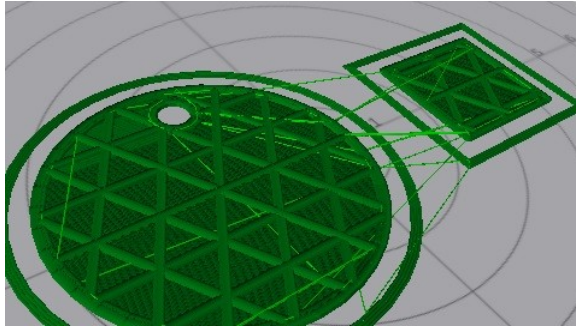
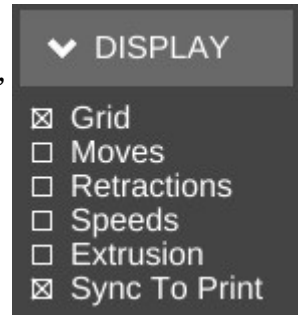

Fig. 28-7: Travel moves.



Retractions show the points in the print where the extruder is going to retract filament from the hot end. This is done either during a non-printing move, or when changing extruders.

The red and blue points in the image to the right show where the retractions are happening.

Red shows the retract operation while the blue color shows the resume/extrude.

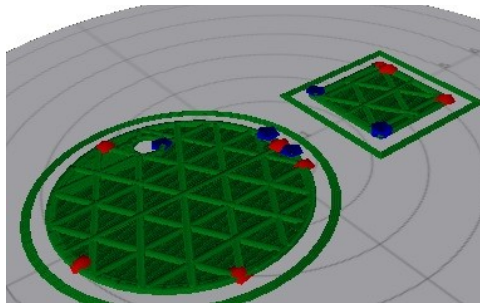

Fig. 28-8: Retracts.

Speeds will color the layers based on how fast the layer is printed.

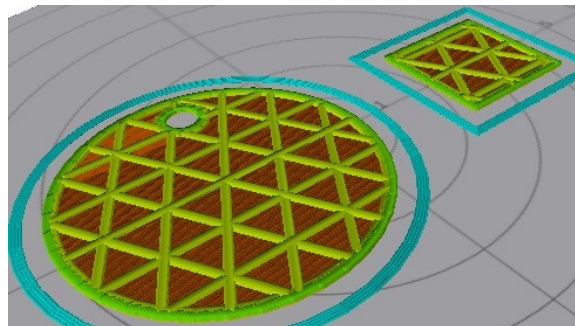

Fig 28-9: Layer speed.

Rostock MAX v2 Assembly Guide

The **Extrusion** option will thicken the lines used to draw the layers in order to give a more accurate visual representation of what the actual print layer will look like when printed.

Finally, **Sync to Print** will allow you to follow the print process using the Layer View. As the Orion prints your part, you'll see a real-time reflection of those moves. It's a pretty nice feature.

Appendix A: Maintenance and Troubleshooting

Like any machine, your Rostock MAX 3D printer needs preventative maintenance to continue to function as good as the day you built it. Vibration and heating/cooling cycles can take their toll and you want to stay ahead of any issues before they begin to adversely affect your prints.

1. Check the condition of your drive belts to insure they're not getting worn out or rubbing on any of the Rostock MAX v2 structure. Check to make sure that a print too close to the bed hasn't caused the drive gear to chew up the belt in one spot. This would be a good item to add to your start-up checklist.
2. Check all bolted connections to ensure that vibration hasn't begun to loosen them. This should be part of your start-up checklist.
3. Check the Cheapskate bearings to ensure that they still have a good hold on the rails. If you leave your Rostock MAX v2 idle for an extended period of time could cause "flat" spots to form on the Acetal bearing covers. You'll know this has happened if you begin to hear "ticks" as the flat spot comes into contact with the rail. The good news is that the flat spot isn't permanent as the Acetal will relax a bit with continued use and the flat spot will disappear.
4. Make sure that the fan in the power supply remains dust-free. Vacuum it out periodically to prevent the buildup of too much dust. Dust traps heat and isn't any good for power supplies.
5. Keep the RAMBo free of dust. Clean it periodically with either canned air or a dry paintbrush. Do **NOT** use a vacuum cleaner on it! The tip of a vacuum cleaner accumulates static electricity and will kill the RAMBo dead as a post.
6. Keep the heated bed free of scratches and debris. If your bed gets too scratched up to be usable, you can either order a new one from SeeMeCNC or go to your local glass shop and order a 300mm diameter disc of glass, 1/8" to 3mm thick. Compare the thickness of the glass and your original build surface. If the glass isn't the same, you may need to re-adjust your Z axis height.

Rostock MAX v2 Assembly Guide

The problem with troubleshooting is sometimes trouble shoots back. :)

Your Rostock MAX v2 3D printer is a pretty complex piece of machinery even though it looks pretty simple. As with any complex device sometimes things can go wrong in really weird ways. This won't be a comprehensive troubleshooting guide, but will touch on a few of the problems I've run into with my printer. As others offer tips, they'll be added to this section.

Print Layer Issues

When you first start a print, you should get a very even and consistent layer height. By properly adjusting the machine, you should get this automatically if you've got all three towers adjusted exactly the same. Unfortunately, that's really difficult to do. The larger the object you print, the more obvious first layer thickness inconsistencies will be, especially when using loops.

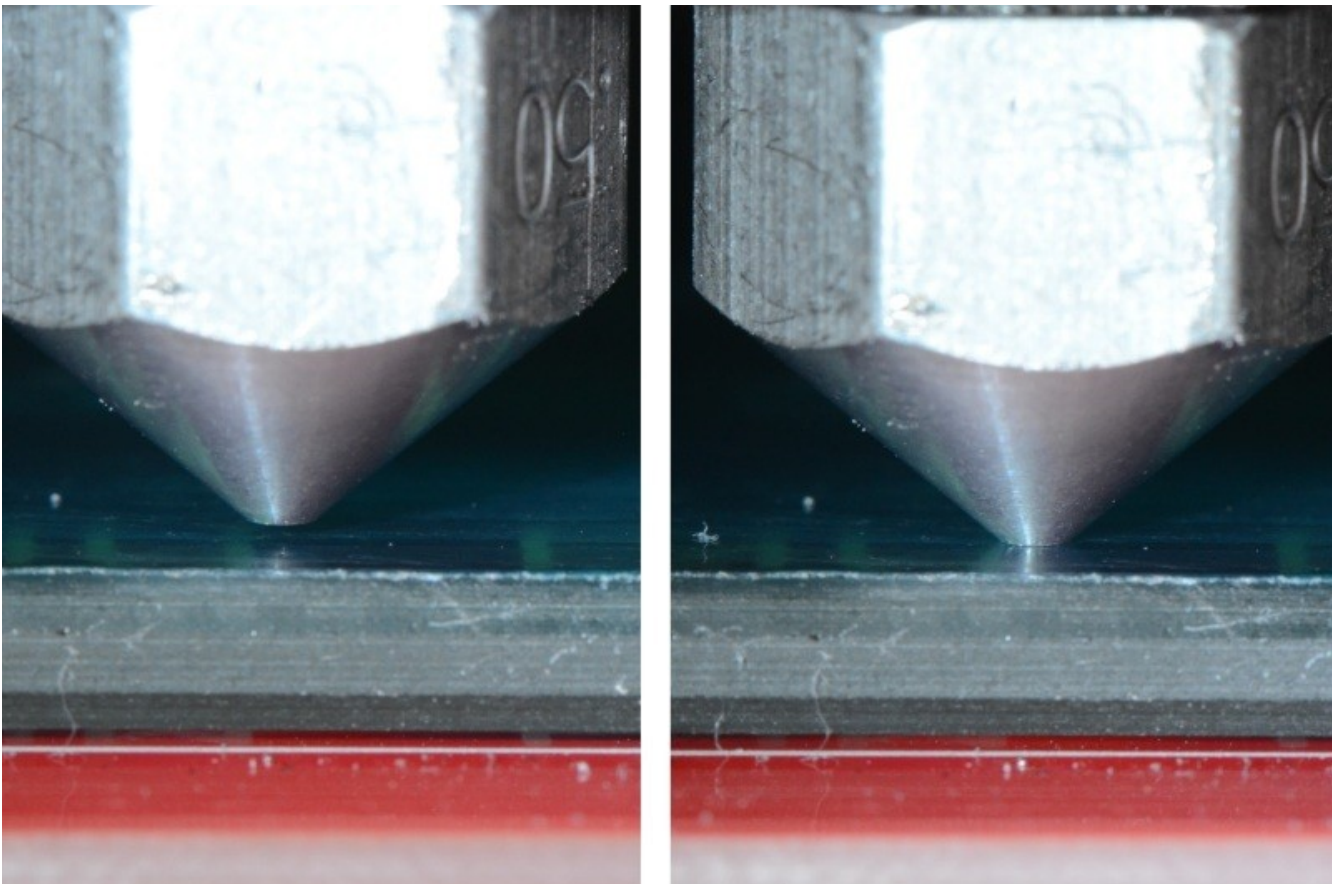

Fig. A-1: Nozzle height examples. (Image Courtesy of LulzBot)

Above is an example of correct and incorrect nozzle height. The nozzle on the right is right at the surface of the print bed. This means that there's no room for the plastic to go – the bed is effectively plugging the nozzle and will eventually cause the extruder to start skipping, or it'll grind a notch in the filament as it tries to feed it.

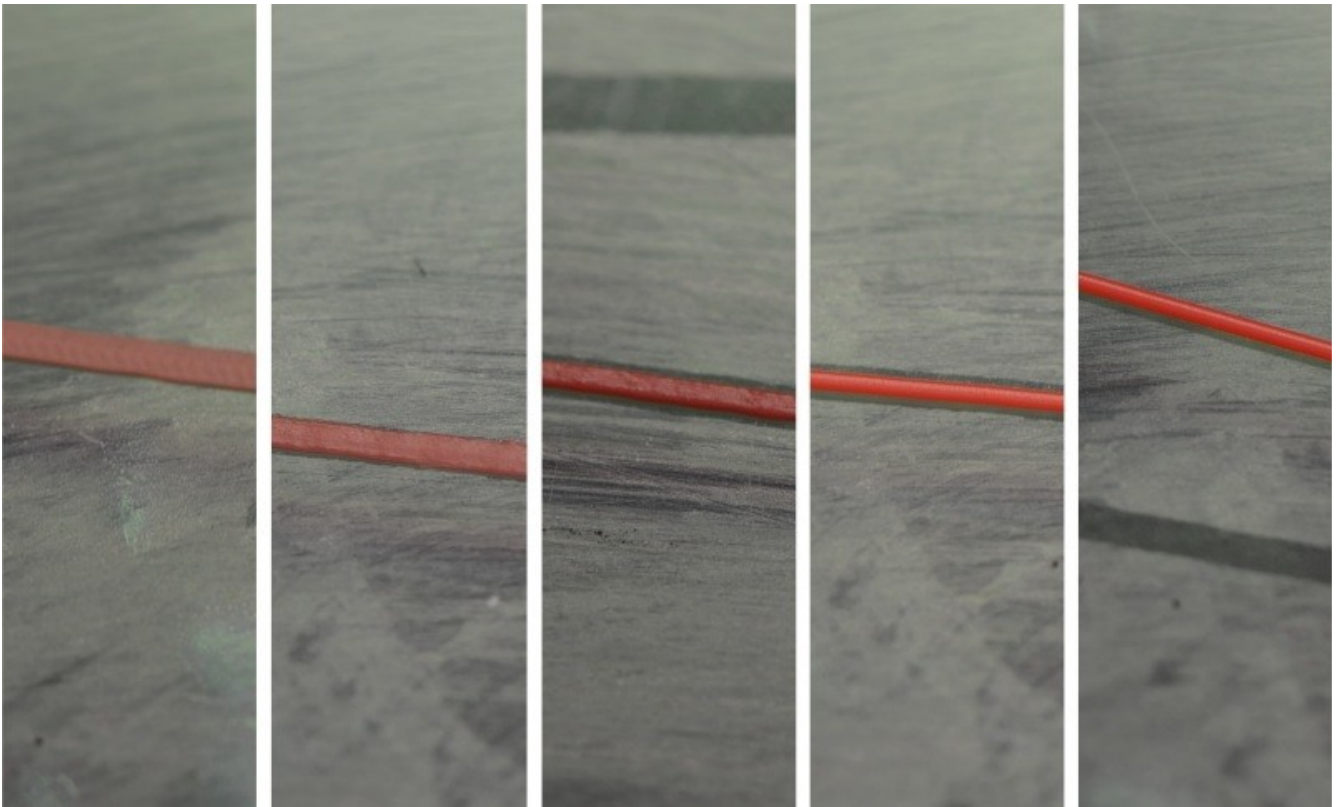

Fig. A-2: First print layer examples. (Image Courtesy of LulzBot)

In the figure above, you'll see five different print examples. On the far left you see the result of the nozzle being too close to the print bed, while at the far right you see the result of the nozzle being too far away. The result you're looking for is shown in the center. That's what a good first layer should look like. If you set the Z height such that you can just begin to feel a sheet of note paper begin to drag between the nozzle and machine bed, you're pretty close to the ideal Z height when at zero.

Machine Won't Move!

You've sent **G28** and the machine still won't move using the jog buttons. Take a look at the

serial terminal output. You may be seeing an error go by that looks like this:

Extruder switched off. MINTEMP triggered!

What is most likely happening is that you haven't yet plugged the hot-end thermistor in. The firmware is preventing the machine from moving because of this – it's a safety measure of sorts. A cold thermistor will read ambient room temperature, but a failed one may not – it could read zero or some very high number. The firmware will prevent the Rostock MAX from operating if the thermistor readings are below 3 degrees Celsius for the hot end and heated bed, or if the hot end temp is above 275 or the heated bed is above 140. (These are defaults and shouldn't be messed with unless you know *exactly* what you're doing)

Belt Damage or The Delta Arm Blues!

So you're printing along and you start to notice things like this:

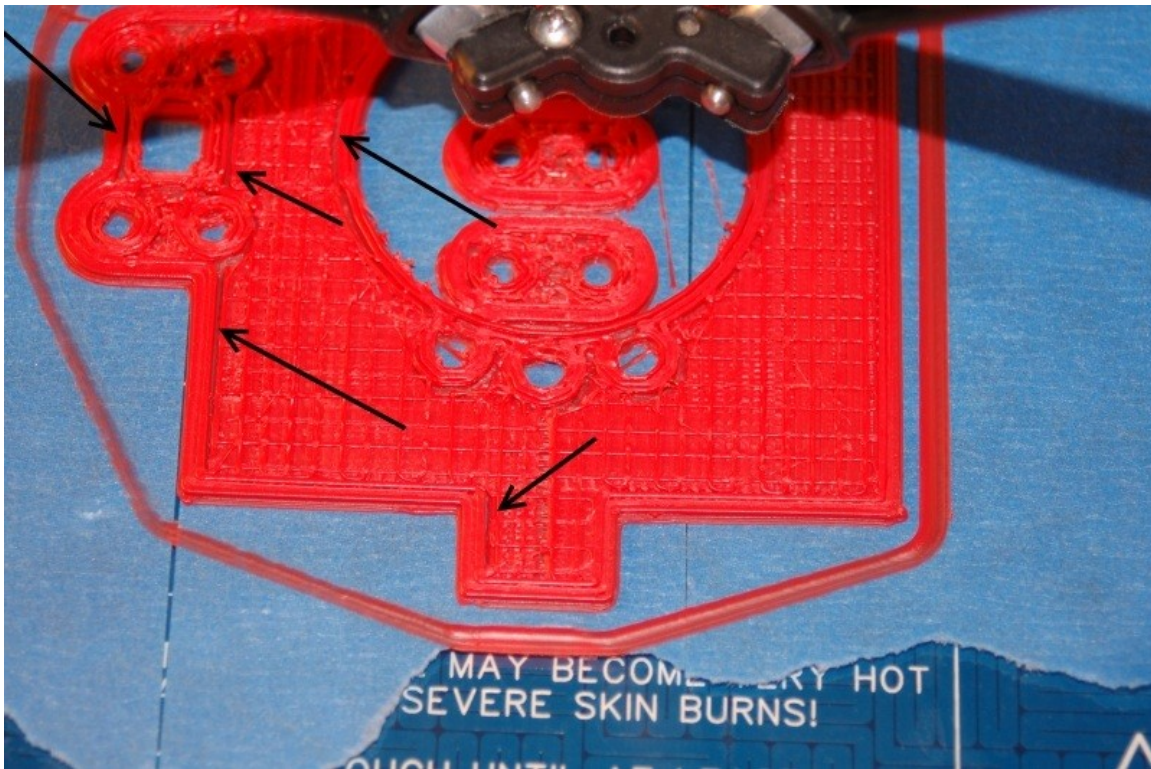

Fig. A-3: Infill not meeting the perimeter.

The arrows are pointing to a gap between the infill and the perimeter of the part. This was caused by a number of factors, eventually resulting in a sharp drive gear devouring all the teeth from a short section of the drive belt. Vigilant belt inspection and more care in setting the Z height would have helped to prevent this from happening.

A sign to watch for is the accumulation of tiny black “crumbs” in the area where the drive

Rostock MAX v2 Assembly Guide

pulley is located. Pull the acrylic covers occasionally to check for this.

Another issue that will cause the problems shown above is known as “The Delta Arm Blues”. What happens is that one or more of the delta arm joints have a little bit of extra friction to them. When the delta platform changes direction, this tiny amount of drag will cause a positioning error resulting in the infill not completely meeting the perimeter. If you're seeing this kind of issue and your belts are in good shape, it's time to test each u-joint for fit. If you've got a tight u-joint even after applying a TINY amount of lithium grease or dry lubricant to it, you may have an axle problem. Contact SeeMeCNC support for further direction.